



# BETAMINI Switches

## Pressure & Temperature



Typical advantages for using the **BETAMINI** are:

- Wide ranges from: **-1 to 540 barg.**
- Wide selection in wetted parts.
- IP 65.
- Excellent repeatability.
- Vibration resistant.
- Field adjustable.
- Maintenance free.
- CE-mark.
- PED approved.
- High overrange pressure, **up to 600 bar.**



**“Quick shipment” – Available –**  
and possible for almost any BETAMINI!

(Consult your local BETA rep. or BETA factory for more details.)

# The “BETAMINI” your special, is our standard.

Over more than 40 years,

BETA designed and produced the best pressure and temperature switches for your customers.

This has given us valuable and detailed experience of industrial needs.

It resulted in a high quality OEM instrument: **The BETAMINI.**

The growing demand for high quality, reliable products has increased the need for better components. No OEM can afford to be less than certain about the components behind his nameplate!

After all, weakest components determines your overall strength.

The “BETAMINI” fulfils the need for a high quality OEM Pressure, and Temperature switch with build-in reliability.

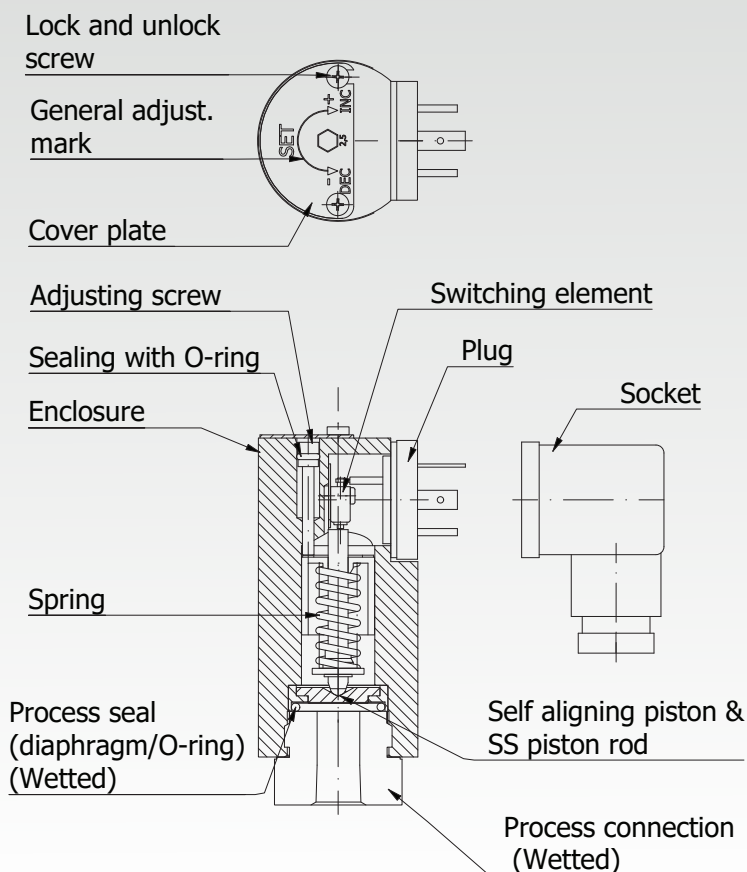

Ready to use, **WORLDWIDE!**

# GUIDE OF HOW TO SELECT: YOUR BETAMINI SWITCH.

BETA uses a simple and logical model code system for easy, accurate product specification, project coordination, efficient document handling and after sales service.

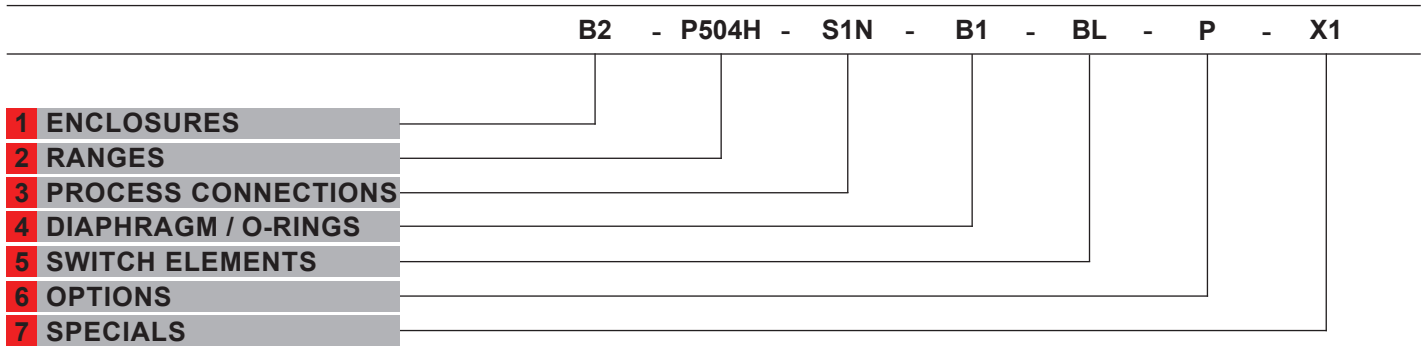

## TO SELECT YOUR SWITCH:

Follow section **1** through **5**

If required:

For "Optional" - and "Special" accessories, follow section **6** or **7**

> Ambient temperature:

Standard: **-30 to +80°C**

> Repeatability:

**± 0.5%** of Full Range\*

(Measured at 20°C ambient temperature acc. to: ANSI/I.S.A.-S51.1-1979).

\*For standard BETA switch (Switch with "BL" switching element and "B1" diaphragm/ O-Ring).

> Free of charge:

BETA will add your tag no. on the nameplate and set the pressure switches at desired setpoint, if this is requested on your order.

> Temperature switches, can also be set at an additional charge.

> Warranty:

**12 months** - rom Ex-works date of manufacture (excl. "wetted parts").

## BETAMINI - PRESSURE SWITCHES:

### 1 ENCLOSURES for Pressure switches

**B2** - P504H - S1N - B1 - BL - P - X1

ENCLOSURE CODE	CLASSIFICATION	ELECTRICAL CONNECTION	MATERIAL	EARTH TERMINAL
<b>B2</b>	Weatheright (IP65)	Hirschmann Plug conn. Type A. ISO4400	Aluminium	Standard (Via plug)

### 2 RANGES for Pressure switches

B2 - **P504H** - S1N - B1 - BL - P - X1

RANGE CODE	ADJUSTABLE RANGE	TYPICAL DEADBAND	MAX. OVERRANGE PRESSURE	PROOF PRESSURE
<b>P 502 H</b>	<sup>1)</sup> 0,3 - 2,0 bar	65 mbar	200 bar	600 bar
<b>P 504 H</b>	<sup>1)</sup> 0,3 - 3,8 bar	85 mbar		
<b>P 506 H</b>	<sup>1)</sup> 0,5 - 10 bar	175 mbar		
<b>P 508 H</b>	<sup>1)</sup> 1,0 - 25 bar	480 mbar		
<b>P 708 H</b>	<sup>1)</sup> 3 - 85 bar	2,25 bar		
<b>P 808 H</b>	<sup>1)</sup> 5 - 170 bar	5 bar	300 bar	
<b>P 908 H</b>	10 - 300 bar	16 bar	400 bar	

1) EC, Type Examination - Directive 97/23/EC-PED, certificate no.: 01202 931-B-11-0009-02

## 2 RANGES for Fluid power switches

B2 - P504H - S1N - B1 - BL - P - X1

RANGE CODE	ADJUSTABLE RANGE		TYPICAL DEADBAND		MAX. OVERRANGE PRESSURE	PROOF PRESSURE
P 904 F	12 - 55	bar	9	bar	650	700
P 908 F	20 - 300	bar	15	bar		
P 918 F	30 - 540	bar	20	bar		

Fluid Power switches are to be used on clean, lubricating fluids only.

## RANGES for Vacuum switches

RANGE CODE	ADJUSTABLE RANGE (Incr. VAC. to PRESS.)	TYPICAL DEADBAND (VAC./ PRESS.)	MAX. OVERRANGE PRESSURE	PROOF PRESSURE
V 506 H	-1/ 0/ +6 bar	80/ 100/ 130 mbar	200 bar	600 bar

## 3 PROCESS CONNECTIONS

B2 - P504H - S1N - B1 - BL - P - X1

PROCESS CONNECT SIZE / CODE	SS 316		BRASS	
	NPT	BSP	NPT	BSP
1/4" F	S1N	S1B		
1/2" F	S2N	S2B		
1/2" M	S7N <sup>1)</sup>	S7B <sup>1)</sup>		
1/4" F			B1N <sup>2)</sup>	B1B <sup>2)</sup>

Other sizes and materials available, consult factory.

1) **NOT** on Fluid Power Pressure Switches.

2) **Standard** on Fluid Power Pressure Switches.



## 4 DIAPHRAGM / O-RINGS

B2 - P504H - S1N - B1 - BL - P - X1

DIAPHRAGM/ O-RING CODE	DIAPHRAGM	O-RING	APPLICATION	DEADBAND MULTIPLIER
B1	Buna-N	Buna-N <sup>1)</sup>	Standard water/ oil (-30°C to +80°C).	1.0
P1	PTFE (Polyimide coated with PTFE)	Buna-N	Oil/ air / water.	1.5
P2		Viton-A <sup>3)</sup>	High temperature NOT below -10°C.	1.5
E6	EPDM	EPDM <sup>1) 2)</sup>	Some hydraulic fluids.	1.0
N3	Neoprene	Neoprene <sup>1) 2)</sup>	When required.	1.0
S0	Welded Diaphragm	None <sup>4)</sup>	High permeative gases.	3.0
S1	SS 316	Buna-N	Highly corrosive and permeative acids.	2.0
S2		Viton-A <sup>3)</sup>	High temperature NOT below -10°C.	2.0
S3		Neoprene	Permeative refrigerant gases.	2.0
V2		Viton-A	Viton-A <sup>3) 2) 1)</sup>	High temperature NOT below -10°C. <sup>3) 2) 1)</sup>

<sup>1)</sup> Fluid power switches are limited to these options. (O-ring only with SS 316 piston).

<sup>2)</sup> Not in combination with option "P".

<sup>3)</sup> For process temperature > 100°C, consult your BETA Switch Representative.

<sup>4)</sup> Only for 1/4" and 1/2" process connections. **Not for vacuum switches.**

**Note:** Wetted parts are suggested for use on the service indicated. However they do not constitute a guarantee against corrosive or permeation since processes vary from plant to plant. Empirical experience by users should be the final guide. The diaphragm/ O-Ring combinations are for process temperatures of -30°C to +80°C, unless otherwise indicated. For process temperatures beyond these limits please contact your BETA Switch Representative.



## 5 SWITCHING ELEMENTS

B2 - P504H - S1N - B1 - **BL** - P - X1

SWITCHING ELEMENT CODE	DESCRIPTION	MAX. RATINGS (RESISTIVE)		DEADBAND MULTIPLIER
		VAC.	VDC	
<b>BL</b>	Standard use	250/ 3A	28/ 3A	1.0
<b>BG</b>	Gold Alloy Contacts	250/ 1A	28/ 1A	1.5

**NOTE:** Switching Elements - ONLY available with **S.P.D.T.** action micro.

## 6 OPTIONS

B2 - P504H - S1N - B1 - BL - **P** - X1

OPTION CODE	DESCRIPTION
<b>B</b>	Industrial cleaning of "wetted" parts for oxygen services.
<b>M</b>	Vacuum protection plate (Standard SS 316).
<b>P</b>	Recommended on strong process pulsations (only on "P..H" range).

## 7 SPECIALS

B2 - P504H - S1N - B1 - BL - P - **X1**

We can incorporate numerous specials to meet your requirements.

These special requirements are indicated by the letter "X" in the model code or at the end of the model number, followed by a figure showing the number of specials.

### Example:

"X1" at the end of model reference means **one** special.

"X2" at the end of the model reference means **two** specials have been incorporated.

Details of each special must always be specified completely on inquiries and orders.

> Example for specials for BETAMINI switches are:

- Special electrical connections.
- Special process connections
- Chemical seals, send us complete specifications if required.

## BETAMINI Pressure & Temperature Switch - Certification:

### Marine Approval

B-series type approval DNV rules for classification:  
DNV-GL-CG-U339

Pressure switches : TAA 0000 2VB

Temperature switches : TAA 0000 2VC



# BETAMINI - TEMPERATURE SWITCHES.

## 1 ENCLOSURE

B2 - T548H - D00 - S0 - BL - X1				
ENCLOSURE CODE	CLASSIFICATION	ELECTRICAL CONNECTION	MATERIAL	EARTH TERMINAL
B2	Weathertight (IP54)	Hirschmann Plug Connection Type A. ISO4400	Aluminium	Standard (Via plug)

## 2 TEMPERATURE RANGES

B2 - T548H - D00 - S0 - BL - X1										
RANGE CODE	ADJUSTABLE RANGE		MAX. DEADBAND		MAX. TEMPERATURE		PROOF TEMPERATURE		MAX. PROCESS PRESSURE	
T 528 H	-40 / +40	°C	5	°C	+125	°C	+200	°C	175	Bar
T 548 H	0 / +80	°C			+200	°C	+250	°C		
T 568 H <sup>1)</sup>	+60 / +180	°C			+300	°C	+350	°C		
T 588 H <sup>2)</sup>	+160 / +300	°C			+400	°C	+450	°C		

<sup>1)</sup> In case process temperature > 140 °C, Direct mount sensing bulb is not recommended.

<sup>2)</sup> Not in combination with Direct mount sensing bulb.

## 3 SENSOR BULBS

B2 - T548H - D00 - S0 - BL - X1				
PROCESS CONNECTION	SENSOR CODE	TYPE OF TEMPERATURE SENSING BULB		
1/2" NPT (M)	D00	Direct mount. <sup>1)</sup>	128 mm length	
	D02		225 mm length	
	C02	Capillary mount.	2 mtr. capillary length	
	C03		3 mtr. capillary length	
	C05		5 mtr. capillary length	
	C10		10 mtr. capillary length	
	CXX		Special capillary length <sup>2)</sup>	

**Note:** All SS 316 stainless steel sensor, capillary (SS 304 armored) and compression fitting.

<sup>1)</sup> Not in combination with range T588H (+160/+300 °C), - and not recommended with T568H in case of process temperature >140 °C.

<sup>2)</sup> Length of capillary should be specified, consult your BETA Switch Representative. (Max.: 15 mtr.)

## 4 DIAPHRAGM / O-RINGS

B2 - T548H - D00 - S0 - BL - X1				
---------------------------------	--	--	--	--

All temperature switches have "S0" (SS 316) welded diaphragm.

## 5 SWITCHING ELEMENTS

B2 - T548H - D00 - S0 - BL - X1				
SWITCHING CODE	APPLICATION	MAX. RATINGS (RESISTIVE)		DEADBAND MULTIPLIER
		VAC.	VDC.	
BL	Standard use	250/ 3A	28/ 3A	1.0
BG	Gold Alloy Contacts	250/ 1A	28/ 1A	1.5

## 6 SPECIALS

B2 - T548H - D00 - S0 - BL - **X1**

We can incorporate numerous specials to meet your requirements.

These special requirements are indicated by the letter "X" in the model code or at the end of the model number, followed by a figure showing the number of specials.

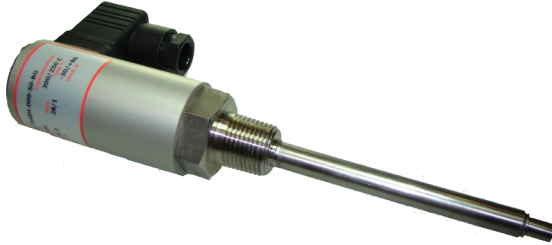

### ACCESSORIES:

Thermowell (SS 316)

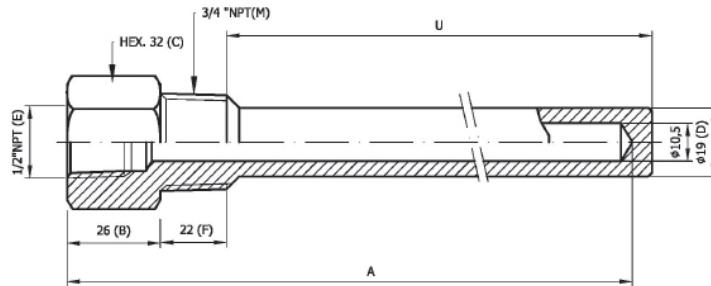

### Standard BETA Thermowell

THERMOWELL CODE	INSERTION ELEMENT LENGTH "U" (MM)	INSERTION ELEMENT LENGTH "A" (MM)	FIT TO BETA TEMPERATURE SENSING BULB
TW 11	115	155	D00, C02, C03
TW 15	155	195	C02, C03, C05
TW 19	190	228	D02, C02, C03, C05

#### NOTES:

- BETA Thermowells to be ordered as separate item.  
**Do not include** Thermowell code into the switch code.
- Special Thermowell possible. Consult your BETA Switch Representative.

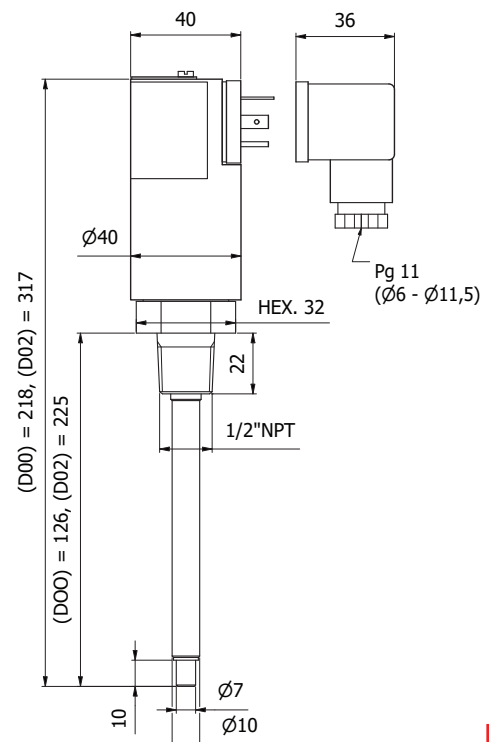
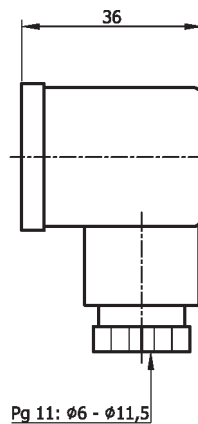
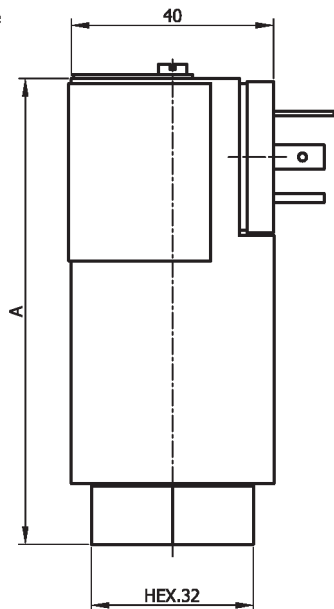
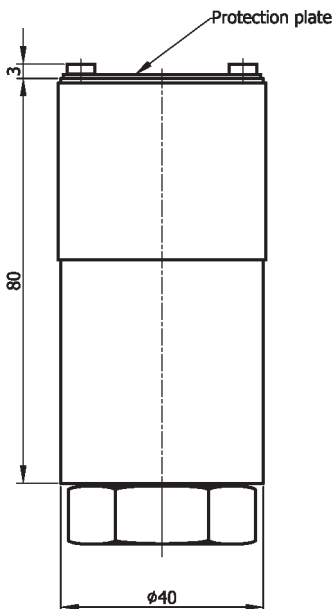

# BETAMINI

Pressure & Temperature

# Switches



**BETA** Pressure & Temperature switches  
are designed & manufactured in The Netherlands

**OFFICE:**

Verrijn Stuartlaan 22  
2288 EL Rijswijk  
The Netherlands



**E-MAIL:**  
2SALES@BETA-B.NL

**TELEPHONE:**  
+31 (0)70 - 319 9700

**INTERNET:**  
WWW.BETA-B.NL

**NOTE:**

We reserve the right to make technical changes or modify the contents of this document without prior notice.  
With regard to purchase orders, the agreed particulars shall prevail. BETA B.V. does not accept any responsibility whatsoever for potential errors or possible lack of information in this document.

We reserve all rights in this document and in the subject matter and illustrations contained therein. Any reproduction, disclosure to third parties or utilization of its contents – in whole or in parts – is prohibited without prior written consent of BETA B.V.