



ModbusRTU



Sample gas cooler

Series TC-MIDI

Installation and Operation Instructions

Original instructions





Bühler Technologies GmbH, Harkortstr. 29, D-40880 Ratingen
Tel. +49 (0) 21 02 / 49 89-0, Fax: +49 (0) 21 02 / 49 89-20
Internet: www.buehler-technologies.com
E-Mail: analyse@buehler-technologies.com

Read this instruction carefully prior to installation and/or use. Pay attention particularly to all advises and safety instructions to prevent injuries. Bühler Technologies can not be held responsible for misusing the product or unreliable function due to unauthorised modifications.

All rights reserved. Bühler Technologies GmbH 2024

Document information

Document No.....BE440016
Version.....03/2024

Contents

1	Introduction	3
1.1	Intended use	3
1.2	Overview	3
1.3	Scope of delivery	3
1.4	Ordering instructions.....	4
1.4.1	Gas cooler models with one gas path inside the heat exchanger	4
1.4.2	Gas cooler models with two gas paths inside the heat exchanger	5
1.4.3	Gas cooler models with one or two gas paths in the heat exchanger for H ₂ /O ₂ applications	6
1.4.4	Gas cooler models with two heat exchangers in series	7
2	Safety instructions	8
2.1	Important advice	8
2.2	General hazard warnings	9
3	Transport and storage	10
4	Installation and connection	11
4.1	Installation site requirements	11
4.2	Installation	11
4.2.1	Connecting the filter gas connections (optional)	11
4.2.2	Flow adapter connection (optional)	11
4.2.3	Connecting the moisture detector (option)	11
4.2.4	Sample gas pump connection gas lines (optional)	12
4.2.5	Peristaltic pump connector (optional).....	12
4.2.6	Connecting the heat exchanger.....	12
4.2.7	Condensate drain connection	13
4.3	Electrical connections.....	13
4.4	Signal outputs	15
5	Operation and control	16
5.1	Description of functions.....	16
5.2	Delta T control option	16
5.3	Use of menu functions.....	17
5.3.1	Lock Menu.....	17
5.3.2	Overview of the menu items	18
5.4	Description of menu functions	20
5.4.1	Display menu.....	20
5.4.2	Main menu.....	20
5.4.3	Submenu 1.....	21
5.4.4	Submenu 1 (global settings).....	22
5.4.5	Set favourite menu.....	26
5.5	Using the Digital Interface.....	27
5.6	Modbus Configuration	27
5.7	Modbus Communication	27
5.8	Modbus Register.....	28
6	Maintenance.....	32
7	Service and repair.....	33
7.1	Troubleshooting	33
7.1.1	Error messages on the display.....	34
7.2	Safety instructions	35
7.3	Cleaning and removal of the heat exchanger.....	36
7.4	Replacing the fuse of the cooler	36
7.5	Replacing the hoses of the peristaltic pump (option)	37
7.6	Replacing the filter element (option)	37
7.7	Drying of the moisture detector (option).....	37
7.8	Calibration of the moisture detector (option)	38
7.9	Replacing sample gas pump inlet and outlet valves (optional)	38
7.10	Replacing the O-ring on the bypass valve (optional)	39

7.11	Replacing the bellow (optional)	39
7.12	Spare Parts.....	40
7.12.1	Consumables and accessories	40
7.12.2	Spare parts and accessories for cooler with -H2/-O2 heat exchanger.....	40
8	Disposal	41
9	Appendices	42
9.1	Gas cooler technical data	42
9.2	Technical Data - Options	45
9.3	Flow diagrams	46
9.4	Dimensions (mm).....	47
9.5	Performance data.....	50
9.6	Heat exchanger	51
9.6.1	Heat exchanger description	51
9.6.2	Heat exchanger overview	52
10	Attached documents	54

1 Introduction

1.1 Intended use

This unit is intended for industrial use in gas analysis systems. It's an essential component for conditioning the sample gas to protect the analysis instrument from residual moisture in the sample gas.

Sample gas coolers with the option for high-purity oxygen (suffix -O2) are optimised especially for use with increased oxygen concentrations with regard to the parts in contact with the medium. Special cleaning of the components to minimise organic and inorganic contamination is mandatory. Manufacturing the products under controlled cleanliness conditions ensures compliance with the limit values in accordance with EIGA Doc 33/18.

Sample gas coolers with the option for high-purity hydrogen (suffix -H2) are specially refined using advanced manufacturing measures, in particular to prevent hydrogen-induced component damage. In addition, the parts in contact with the media are subjected to an additional visual inspection to remove any residual metallic contamination, such as chips and particles. Finally, a leak test is carried out as standard.

For passing of flammable gases, make sure that the parts carrying and/or in contact with the medium are tightly connected.

Please note the specifications in the data sheet on the specific intended use, existing material combinations, as well as pressure and temperature limits.

1.2 Overview

The TC-MIDI series was designed specifically for high cooling capacities and high ambient temperatures.

The TC-MIDI+ series was designed specifically for the requirements of automated measuring systems (AMS) according to EN 15267-3. The series connection of the heat exchangers will cool in two cycles to minimise wash-out effects.

The TC-MIDI with -H2/-O2 heat exchanger series was specially developed for use with high-purity hydrogen and oxygen.

The Peltier coolers are distinguished by two types according to cooling capacity/operating temperature. This classification is reflected in the type designation. The exact item number of the model defined by you is determined by the model code in the ordering information category.

Application	Standard applications	
Operating temperature	40 °C	50 °C
1 heat exchanger (single or double)	TC-MIDI 6111	TC-MIDI 6112
1 heat exchanger for H ₂ /O ₂ applications	TC-MIDI 6111	TC-MIDI 6112
2 heat exchangers in series	TC-MIDI+ 6121	TC-MIDI+ 6122

Additional components which every conditioning system should feature can optionally be integrated:

- Peristaltic pump for condensate separation,
- Filter,
- Moisture detector,
- sample gas pump.

In addition, we offer different signal outputs:

- Status output
- Analog output, 4...20 mA, incl. status output,
- Modbus RTU digital output, incl. status output

This allows for various configurations of cooler and options. Here the approach is to simplify creating a complete system in a cost-efficient way through pre-installed components with hoses connected. We further paid attention to easy access to wear parts and consumables.

1.3 Scope of delivery

- Cooler
- Product documentation
- Connection-/mounting accessories (optional)

1.4 Ordering instructions

1.4.1 Gas cooler models with one gas path inside the heat exchanger

The item number is a code for the configuration of your unit. Please use the following model code:

4496 3 1 1 X 0 X 1 X X X X X X 0 X 0 0													Product Characteristics
													Gas cooler models
1													TC-MIDI 6111: Ambient temperature 40 °C
2													TC-MIDI 6112: Ambient temperature 60 °C
													Certifications
0													Standard applications – CE
													Supply voltage
1													115 V AC, 50/60 Hz
2													230 V AC, 50/60 Hz
													Heat exchanger
1	1	0											Stainless steel, TS, metric
1	1	5											Stainless steel, TS-I, US
1	2	0											Duran glass, TG, metric
1	2	5											Duran glass, TG-I, US
1	3	0											PVDF, TV-SS, metric
1	3	5											PVDF, TV-SS-I, US
													Condensate drain ²⁾
0													without condensate drain
1													CPsingle with hose nipple, angled
3													CPsingle with screw connection ⁴⁾
													Sample gas pumps ¹⁾
0													without sample gas pump
1													P1, PVDF, bottom mounted
2													P1, with bypass valve, bottom mounted
6													P1, PVDF, mounted externally
7													P1, with bypass valve, side mounted
													Moisture detector ²⁾ / Filter
0	0												without filter, without moisture detector
0	1												without filter, 1 moisture detector with PVDF adapter ³⁾
1	0												1 filter, without moisture detector
1	1												1 filter with built-in moisture detector
													Signal outputs
0	0												status output only
1	0												Analog output, 4..20 mA, incl. status output
2	0												Modbus RTU digital output, incl. status output
													Delta T control
0	0												without Delta T control
1	0												Delta T control option

¹⁾ Factory installed tubing for suction operation.

²⁾ With this option, the maximum ambient temperature is limited to 50 °C.

³⁾ Also available in stainless steel.

⁴⁾ Metric or US connection, per heat exchanger.

1.4.2 Gas cooler models with two gas paths inside the heat exchanger

The item number is a code for the configuration of your unit. Please use the following model code:

4496	3	1	1	X	0	X	2	X	X	X	X	X	X	X	0	X	0	0	Product Characteristics
Gas cooler models																			
1 TC-MIDI 6111: Ambient temperature 40 °C																			
2 TC-MIDI 6112: Ambient temperature 60 °C																			
Certifications																			
0 Standard applications – CE																			
Supply voltage																			
1 115 V AC, 50/60 Hz																			
2 230 V AC, 50/60 Hz																			
Heat exchanger																			
2 6 0 Stainless steel, DTS, metric																			
2 6 5 Stainless steel, DTS-I, US																			
2 6 1 Stainless steel, DTS 6, metric ¹⁾																			
2 6 6 Stainless steel, DTS 6-I, US ¹⁾																			
2 7 0 Duran glass, DTG, metric																			
2 7 5 Duran glass, DTG-I, US																			
2 8 0 PVDF, DTV, metric ¹⁾																			
2 8 5 PVDF, DTV-I, US ¹⁾																			
Condensate drain ⁴⁾																			
0 without condensate drain																			
2 CPdouble with hose nipple, angled																			
4 CPdouble with screw connection ⁶⁾																			
Sample gas pumps ³⁾																			
0 without sample gas pump																			
1 P1, 1 gas path, PVDF, bottom mounted																			
2 P1, 1 gas path, with bypass valve, bottom mounted																			
6 P1, 1 gas path, PVDF, mounted externally ²⁾																			
7 P1, 1 gas path, with bypass valve, side mounted ²⁾																			
Moisture detector ⁴⁾ / Filter																			
0 0 without filter, without moisture detector																			
0 1 without filter, 1 moisture detector with PVDF adapter																			
0 2 without filter, 2 moisture detectors with PVDF adapter ⁵⁾																			
1 0 1 filter, without moisture detector																			
1 1 1 filter with built-in moisture detector																			
2 0 2 filters, without moisture detector ²⁾																			
2 1 2 filters, 1 moisture detector ²⁾																			
2 2 2 filters, 2 moisture detectors ²⁾																			
Signal outputs																			
0 0 status output only																			
1 0 Analog output, 4..20 mA, incl. status output																			
2 0 Modbus RTU digital output, incl. status output																			
Delta T control																			
0 0 without Delta T control																			
1 0 Delta T control option																			

¹⁾ Condensate outlets only suitable when connecting peristaltic pumps.

²⁾ External sample gas pump P1 only allows 1 filter.

³⁾ Factory installed tubing for suction operation.

⁴⁾ With this option, the maximum ambient temperature is limited to 50 °C.

⁵⁾ Also available in stainless steel.

⁶⁾ Metric or US connection, per heat exchanger.

1.4.3 Gas cooler models with one or two gas paths in the heat exchanger for H2/O2 applications

The item number is a code for the configuration of your unit. Please use the following model code:

4496	3	1	1	X	0	X	X	X	X	0	0	0	0	X	0	X	0	X	Product Characteristics
Gas cooler models																			
1 TC-MIDI 6111: Ambient temperature 40 °C																			
2 TC-MIDI 6112: Ambient temperature 60 °C																			
Certifications																			
0 Standard applications – CE																			
Supply voltage																			
1 115 V AC, 50/60 Hz																			
2 230 V AC, 50/60 Hz																			
Heat exchanger																			
1 1 0 -O2 Stainless steel, TS-O2, metric																			
1 1 5 -O2 Stainless steel, TS-I-O2, US																			
1 1 0 -H2 Stainless steel, TS-H2, metric																			
1 1 5 -H2 Stainless steel, TS-I-H2, US																			
2 6 0 -O2 Stainless steel, DTS-O2, metric																			
2 6 5 -O2 Stainless steel, DTS-I-O2, US																			
2 6 0 -H2 Stainless steel, DTS-H2, metric																			
2 6 5 -H2 Stainless steel, DTS-I-H2, US																			
Signal outputs																			
0 0 status output only																			
1 0 Analog output, 4..20 mA, incl. status output																			
2 0 Modbus RTU digital output incl. status output																			
Delta T control																			
0 0 without Delta T control																			
1 0 Delta T control option																			

1.4.4 Gas cooler models with two heat exchangers in series

The item number is a code for the configuration of your unit. Please use the following model code:

4496 3 1 2 X 0 X 1 X X X X X X X 0 0 0 0													Product Characteristics	
Gas cooler models														
1														TC-MIDI+ 6121: Ambient temperature 40 °C
2														TC-MIDI+ 6122: Ambient temperature 60 °C
Certifications														
0														Standard applications – CE
Supply voltage														
1														115 V AC, 50/60 Hz
2														230 V AC, 50/60 Hz
Heat exchanger														
1	2	2												Duran glass, STG-2, metric
1	2	7												Duran glass, STG-2-I, US
1	3	2												PVDF, STV-2, metric ¹⁾
1	3	7												PVDF, STV-2-I, US ¹⁾
Condensate drain ⁴⁾														
0														without condensate drain
2														CPdouble with hose nipple, angled
4														CPdouble with screw connection ⁶⁾
Sample gas pumps ³⁾														
0														without sample gas pump
1														P1, 1 gas path, PVDF, bottom mounted
2														P1, 1 gas path, with bypass valve, bottom mounted
6														P1, 1 gas path, PVDF, mounted externally ²⁾
7														P1, 1 gas path, with bypass valve, side mounted ²⁾
Moisture detector ⁴⁾ / Filter														
0	0													without filter, without moisture detector
0	1													without filter, 1 moisture detector with PVDF adapter ⁵⁾
1	0													1 filter, without moisture detector
1	1													1 filter with built-in moisture detector
Signal outputs														
0	0													status output only
1	0													Analog output, 4..20 mA, incl. status output
2	0													Modbus RTU digital output, incl. status output

¹⁾ Condensate outlets only suitable when connecting peristaltic pumps.

²⁾ External sample gas pump P1 only allows 1 filter.

³⁾ Factory installed tubing for suction operation.

⁴⁾ With this option, the maximum ambient temperature is limited to 50 °C.

⁵⁾ Also available in stainless steel.

⁶⁾ Metric or US connection, per heat exchanger.

2 Safety instructions

2.1 Important advice

Operation of the device is only permitted if:

- the product is used under the conditions described in the installation- and operation instruction, the intended application according to the type plate and the intended use. In case of unauthorized modifications done by the user Bühler Technologies GmbH can not be held responsible for any damage,
- when complying with the specifications and markings on the nameplates.
- the performance limits given in the datasheets and in the installation- and operation instruction are obeyed,
- monitoring devices and safety devices are installed properly,
- service and repair is carried out by Bühler Technologies GmbH,
- only original spare parts are used.

This manual is part of the equipment. The manufacturer keeps the right to modify specifications without advanced notice. Keep this manual for later use.

Signal words for warnings

DANGER	Signal word for an imminent danger with high risk, resulting in severe injuries or death if not avoided.
WARNING	Signal word for a hazardous situation with medium risk, possibly resulting in severe injuries or death if not avoided.
CAUTION	Signal word for a hazardous situation with low risk, resulting in damaged to the device or the property or minor or medium injuries if not avoided.
NOTICE	Signal word for important information to the product.

Warning signs

These instructions include the following warnings:

	General warning sign		General mandatory sign
	Voltage warning		Unplug from mains
	Warning not to inhale toxic gases		Wear respiratory equipment
	Warning of corrosive substances		Wear a safety mask
	Warning of explosion hazard		Wear gloves

2.2 General hazard warnings

The equipment must be installed by a professional familiar with the safety requirements and risks.

Be sure to observe the safety regulations and generally applicable rules of technology relevant for the installation site. Prevent malfunctions and avoid personal injuries and property damage.

The operator of the system must ensure:

- Safety notices and operating instructions are available and observed,
- The respective national accident prevention regulations are observed,
- The permissible data and operational conditions are maintained,
- Safety guards are used and mandatory maintenance is performed,
- Legal regulations are observed during disposal,
- compliance with national installation regulations.
- the device is protected from mechanical loads.

Maintenance, Repair

Please note during maintenance and repairs:

- Repairs to the unit must be performed by Bühler authorised personnel.
- Only perform conversion-, maintenance or installation work described in these operating and installation instructions.
- Always use genuine spare parts.
- Do not install damaged or defective spare part. If necessary, visually inspect prior to installation to determine any obvious damage to the spare parts.

Always observe the applicable safety and operating regulations in the respective country of use when performing any type of maintenance.

DANGER

Electrical voltage



Electrocution hazard.

- a) Disconnect the device from power supply.
- b) Make sure that the equipment cannot be reconnected to mains unintentionally.
- c) The device must be opened by trained staff only.
- d) Regard correct mains voltage.



DANGER

Toxic, corrosive gas/condensate



Sample gas/condensate may be hazardous to health.

- a) If necessary, ensure a safe gas/condensate discharge.
- b) Always disconnect the gas supply when performing maintenance or repairs.
- c) Protect yourself from toxic/corrosive gasses/condensate when performing maintenance. Wear appropriate protective equipment.



DANGER

Potentially explosive atmosphere



Explosion hazard if used in hazardous areas.

The device is not suitable for operation in hazardous areas with potentially explosive atmospheres.

Do not expose the device to combustible or explosive gas mixtures.

3 Transport and storage

Only transport the product inside the original packaging or a suitable alternative.

The equipment must be protected from moisture and heat when not in use. It must be stored in a covered, dry and dust-free room at a temperature of -20 °C to 60 °C (-4 °F to 140 °F).

In particular for sample gas coolers with stainless steel heat exchangers for O_2 applications (suffix -O2), it is essential to rule out any contamination of components in contact with the media during storage.

4 Installation and connection

4.1 Installation site requirements

The unit is only intended for wall-mounted use in enclosed areas. Adequate protection from the weather must be provided when used outdoors.

Install the unit leaving enough room below the cooler to discharge the condensate. Leave room above for the gas supply.

Be sure to maintain the approved ambient temperature. Do not obstruct the convection of the cooler. The vents must have enough room to the next obstacle. The distance must especially be a minimum of 10 cm on the air outlet side.

Ensure adequate ventilation when installing in enclosed housings, e.g. analyser cabinets. If the convection is inadequate, we recommend aerating the cabinet or installing a fan to lower the inside temperature.

CAUTION

Contamination of cleaned components



For sample gas coolers with stainless steel heat exchangers for O₂ applications (suffix -O₂), contamination with oil, grease, dust, particles, lint, hair, etc. must be ruled out for fire protection reasons when working on components that come into contact with media. If necessary, adapt your operational and organisational measures with regard to the work clothing to be used, hygiene regulations, etc. If necessary, move such work to a suitable, cleaner work area.



4.2 Installation

Run the gas supply to the cooler with a downward slope. The gas inputs are marked in red and additionally labelled "IN".

If a large amount of condensate accumulates, we recommend using a condensate trap with automatic condensate drain. Our condensate drains, 11 LD V38, AK 20, AK 5.5 OR AK 5.2, are suitable.

Glass vessels and automatic condensate drains are available for draining condensate for external mounting below the unit. When using automatic condensate drains, the sample gas pump must be installed upstream of the cooler (pressure operation) to ensure proper function of the condensate drain.

If the sample gas pump is located at the cooler outlet (suction operation), we recommend using glass condensate traps or peristaltic pumps.

With the option for high-purity water or oxygen (suffix -H₂/-O₂), the components are each supplied in separate packaging. To prevent soiling, these should only be unpacked shortly before use.

4.2.1 Connecting the filter gas connections (optional)

The connection between the heat exchanger outlet and the filter inlet does not have tubing included. The connection G1/4 or NPT 1/4" (filter head marked NPT) for the gas outlet must be carefully and properly connected using a suitable screw connection.

When ordering the cooler with the **option filter without Moisture detector**, a bypass may be connected to the filter head.

The filter head is intended for a G1/4 internal screw thread which is plugged at the factory. To use it, unscrew the plug and screw in a suitable screw connection. Pay attention to leaks.

NOTICE



Installing **filters** limits the maximum approved **operating pressure** in the system!
Operating pressure ≤ 2 bar

4.2.2 Flow adapter connection (optional)

When ordering the cooler with the **option moisture detector without filter**, it will be factory installed inside a flow adapter.

The connection between the heat exchanger outlet and the flow adapter inlet already has tubing. The connection G 1/4 or NPT 1/4" (flow adapter marked NPT) for the gas outlet must be carefully and properly connected using a suitable screw connection.

4.2.3 Connecting the moisture detector (option)

When ordering the cooler with **moisture detector option**, it will be factory installed inside a flow adapter, or for the **filter option** installed and connected in the filter head.

4.2.4 Sample gas pump connection gas lines (optional)

On coolers ordered with attached sample gas pump these are already installed and wired. Add-on parts ordered at the same time are already installed and connected to the sample gas pump.

The sample gas pump may be installed both below and next to the cooler.

Avoid mixed-material installation, i.e. metal piping to plastic bodies. If this cannot be avoided in isolated applications, screw the metal connections into the pump body with care, never use force.

Lay the lines so the line at the inlet and outlet remains flexible for an adequate distance.

The pumps are marked **IN** for inlet and **OUT** for outlet at the mounting ring. Be sure the gas line connections are tight.

4.2.5 Peristaltic pump connector (optional)

Coolers ordered with attached peristaltic pump already have it installed and wired. Heat exchangers ordered at the same time are already installed and connected to the peristaltic pump.

The $\varnothing 6$ mm (0.24 inch) hose nipple for the pump's condensate outlet must be carefully and properly connected with a suitable hose and hose clamp.

Versions with screw connections DN 4/6 or 1/6"-1/4" are supplied with ferrule and knurled nut and must be carefully sealed with appropriate hose.

NOTICE



Installing peristaltic **pumps** CPsingle / CPdouble limits the maximum permissible **operating pressure** in the system!
Operating pressure ≤ 1 bar

4.2.6 Connecting the heat exchanger

The picture on the left shows the schematics for connecting (two) separate heat exchangers.

To minimise gas wash out in the cooler, the two (identical) heat exchangers must be operated in series (right picture). This should be done as follows:

1. Gas inlet line to red gas inlet on heat exchanger 2 (pre-cooling).
2. Connection between gas outlet on heat exchanger 2 and the red gas inlet on heat exchanger 1 (after-cooling).
3. Attaching the final gas output line to the gas outlet on heat exchanger 1.

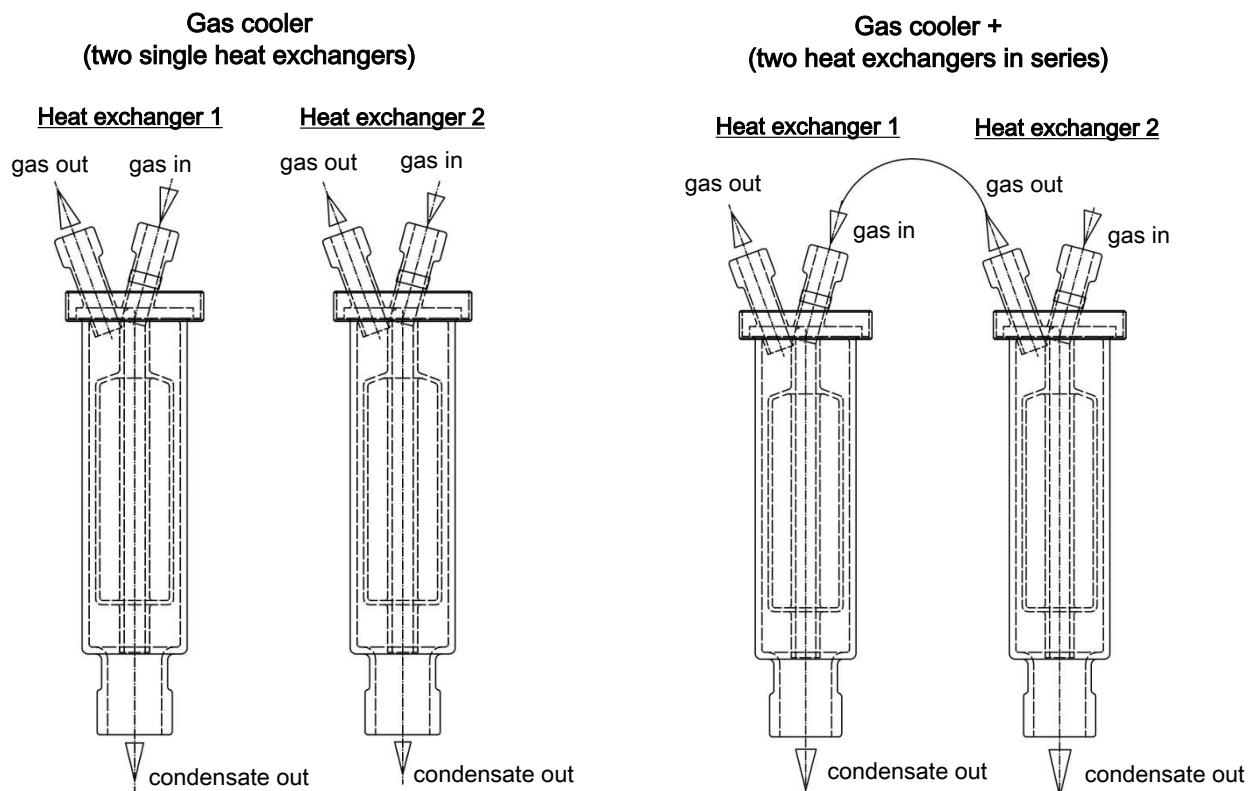

The gas inputs are marked in red.

On glass heat exchangers, the correct position of the seal is important when connecting the gas lines (see image). The seal consists of a silicone ring with a PTFE sleeve. The PTFE side must face the glass thread.

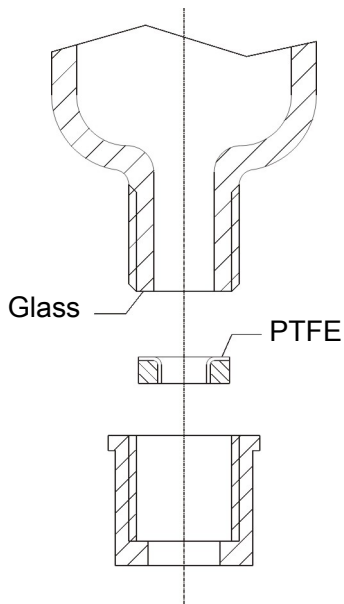

Pay attention to the appropriate spanner size when selecting fittings for stainless steel heat exchangers.

TS/TS-I gas connections: SW 17

TS/TS-I condensate out connections: SW 22

4.2.7 Condensate drain connection

Depending on the material, build a connecting line with fittings and tubing or hose between the heat exchanger and condensate drain. For stainless steel, the condensate drain can be hung directly from the connecting tube; for hoses, the condensate drain must be secured separately using a clamp.

The condensate drain can be mounted directly to the heat exchanger.

When choosing the option for high-purity oxygen, make sure to select the suffix -O2.

If the condensate drain 11 LD V 38 is used for high hydrogen concentrations, the system in which it is installed must be tested for leaks.

Condensate lines must always be installed with a slope and a minimum inside diameter of DN 8/10 (5/16").

4.3 Electrical connections

The operator must install an external separator for the device which is clearly assigned to this device.

This separator

- must be located near the device,
- must be easy for the operator to reach,
- must comply with IEC 60947-1 and IEC 60947-3,
- must separate all live conductors and the status output, and
- must not be attached to the power feed.

WARNING



Hazardous electrical voltage

The device must be installed by trained staff only.

CAUTION



Wrong mains voltage

Wrong mains voltage may damage the device.
 Regard the correct mains voltage as given on the type plate.

WARNING



High voltage

Damage to the device in case of insulation testing
Do not proceed insulation tests with high voltage to the device as a whole!

Electric strength test

This device is equipped with extensive EMC protection. The necessary tests were carried out at the factory (test voltage 2.1 kV or 2.55 kV DC depending on approval).

If you wish to check the electric strength again yourself, you can do so on the entire unit. Only test the device with the specified values using direct current voltage. Testing the electric strength with alternating current voltage will damage electronic components. The recommended voltage in this case is 2.1 kV DC, 2 s. Disconnect all supply lines from the device before testing. Power can be supplied via the mains connection.

Plug connection

This device has one EN 175301-803 plug each for the power supply and the signal output. If the lead is connected correctly, these cannot be confused. Therefore please be sure to correctly reassemble the plugs after connecting the wires. Below you will find the pin assignments, with the numbers corresponding to those on the plugs:

The supply line cross-sections must be suitable for the rated current. Use a maximum line cross-section of 1.5 mm² (AWG 16) and a cable diameter of 8 - 10 mm (0.31 - 0.39 inch).

Shielded signal lines are required to connect the analog output or the digital interface.

Plug numbering

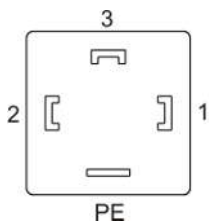

Electric supply S1

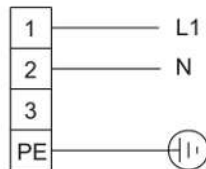

Alarm contact S2

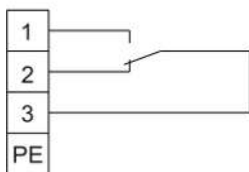

Analog output S3

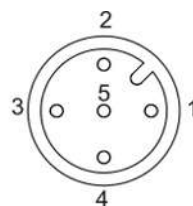

- 1 - not assigned
- 2 - not assigned
- 3 - GND
- 4 - 4-20 mA out
- 5 - shield

Digital output S4

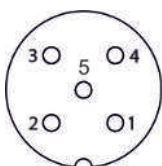

- 1 - not used
- 2 - RS485 A
- 3 - GND/Common
- 4 - RS485 B
- 5 - Shielding

The clamping areas for S1 and S2 are 8 - 10 mm (0.31 – 0.39 inches) in diameter.

4.4 Signal outputs

The device provides different status signals. The maximum switching load of the alarm outputs is limited to 250 V AC/150 V DC, 2 A, 50 VA each.

An alarm is triggered by the alarm contact/status output (S2) if the temperature of the cooler is outside the specified limits. It does not indicate if the alarm was triggered due to excess temperature or insufficient temperature.

The front film has three LEDs:

Colour	Marking	Function
Red	S2	High/low temperature, device error
Yellow	S1	---
Green	OP	Normal operation

The LEDs OP and S2 indicate the device status similar to S2.

If the option “temperature signal” is built in, the unit has a signal output via the analogue output to indicate the actual cooler temperature.

When the moisture detector (optional) is installed, an alarm is activated by the alarm contact/status output (S2) if the moisture is still present in the prepared sample gas. Thereby, no distinction is made between the alarm/cable break triggered by moisture detector 1 or 2. This information is displayed by an error message instead.

The temperature signal can be read via the panel plug (S3) using the M12x1 connector. This plug is located next to the moisture detector connectors at the top of the cooler.

Description of signal outputs

	Function/contact type	Description	
Regarding S2)	internal changeover contact: max. 250 VAC/150 VDC, 2 A, 50 VA	the following device statuses can be indicated via two switching outputs:	Contact between 3 and 2 closed (alarm) <ul style="list-style-type: none"> – No mains voltage and/or actual temperature outside the alarm thresholds Contact between 3 and 1 closed (OK) <ul style="list-style-type: none"> – Mains voltage attached + actual temperature within the alarm thresholds With moisture detector option Contact between 3 and 2 closed (alarm) <ul style="list-style-type: none"> – The moisture detector registers residual humidity in the sample gas or cable break: Error message Contact between 1 and 3 closed (OK) <ul style="list-style-type: none"> – no residual moisture in measuring gas/no cable break With temperature signal option
Regarding S3)	4-20 mA analogue output ($R_{Load} < 500 \Omega$)	Signalling of actual temperature	$T_{cooler} = -20 \text{ °C } \triangleq (-4 \text{ °F}) \rightarrow 4 \text{ mA} / 2 \text{ V}$ $T_{cooler} = 5 \text{ °C } \triangleq (41 \text{ °F}) \rightarrow 9 \text{ mA} / 4.5 \text{ V}$ $T_{cooler} = 60 \text{ °C } \triangleq (140 \text{ °F}) \rightarrow 20 \text{ mA} / 10 \text{ V}$
Regarding S4)	Digital output	Modbus RTU (RS-485)	Interface default values Baudrate – parity – stop bit: 19200 – Even – 1 Default ID: 10 The bus lines are not internally terminated.

5 Operation and control

NOTICE



The device must not be operated beyond its specifications.

After switching on the cooler the block temperature will be displayed. The display will flash until the block temperature has reached the preset target value (\pm adjustable alarm range). The status contact is in the Alarm position.

Once the target temperature range has been reached, the temperature will continuously be displayed and the status contact switches over.

If the display flashes during operation or an error message appears, please refer to bullet "Troubleshooting".

Please refer to the data sheet for performance data and maximum ratings.

5.1 Description of functions

The cooler is controlled by a microprocessor. With the factory preset the control already incorporates the various characteristics of the built-in heat exchangers.

The programmable display shows the block temperature in the selected display unit ($^{\circ}\text{C} / ^{\circ}\text{F}$) (factory preset $^{\circ}\text{C}$). Application-specific settings can easily be configured guided by the menu, using the 5 buttons. For one, this applies to the target outlet dew point, which can be set from 2 to 20 $^{\circ}\text{C}$ (36 $^{\circ}\text{F}$ to 68 $^{\circ}\text{F}$) (factory preset 5 $^{\circ}\text{C}/41^{\circ}\text{F}$).

And then the warning thresholds can be adjusted for low and excess temperature. These are set relative to the outlet dew point τ_a setting.

For the low temperature the range is $\tau_a - 1$ to $- 3 \text{ K}$ (at a minimum 1 $^{\circ}\text{C} / 34^{\circ}\text{F}$ cooling block temperature), for the excess temperature the range is $\tau_a + 1$ to $+ 7 \text{ K}$. The factory presets for both values are 3 K.

The flashing display and the status relays indicate the conditions are below or above the configured warning range (e.g. after switching on).

The status output can e.g. be used to control the sample gas pump to allow for the gas flow to only be switched on once the permissible cooling range has been reached or shut off the pump in the event of a moisture detector alarm.

The separated condensate can be drained via connected peristaltic pumps or add-on automatic condensate drains.

Fine mesh filters can also be used, which in turn can be installed in optional moisture detectors.

The glass dome allows the dirt level of the filter element to easily be determined.

The moisture detector is easy to remove. This may be required if a condensate enters the cooler due to a malfunction and the peristaltic pump or the automatic condensate drain is unable to remove it.

A P1 gas pump can be attached to the gas cooler, optionally also with bypass valve for regulating the flow. This allows the sample gas pump to be expanded by a single-leg system, so when equipped with a single heat exchanger or for the respective application the two gas paths of the dual heat exchangers are switched in series, for example Cooling 1 – Pump – Cooling 2.

5.2 Delta T control option

Not all applications require an outlet dew point of 5 $^{\circ}\text{C}$ (41 $^{\circ}\text{F}$). In some applications a higher dew point is sufficient. In other applications a stable outlet dew point doesn't matter, it's enough for the gas to be dry, so if the outlet dew point has an adequate difference in temperature below the ambient temperature.

Here the electronics measure the ambient temperature and regulate the outlet dew point to an adjustable value below it. This extends the potential cooling capacity to the limits of the heat exchanger. Here it's important to note the outlet dew point fluctuates along with the ambient temperature and a stable dew point cannot be a prerequisite for the measurement.

The target temperature range is defined by the ambient temperature, the adjustable temperature difference and the alarm limits. If the block temperature is not within the target range with active Delta T-control, the status message "*dt*" will flash in the display.

Example: At a difference of 30 $^{\circ}\text{C}$ (30 K/54 $^{\circ}\text{F}$), at a set outlet dew point of 5 $^{\circ}\text{C}$ (41 $^{\circ}\text{F}$) this means the dew point remains stable up to an ambient temperature of approx. 35 $^{\circ}\text{C}$ (95 $^{\circ}\text{F}$), and the safe drop is only preferred over the ambient temperature with ambient temperature peaks over 35 $^{\circ}\text{C}$ (95 $^{\circ}\text{F}$). The cooling capacity specified in the cooling capacity graphs at 35 $^{\circ}\text{C}$ (95 $^{\circ}\text{F}$) is then available at above 35 $^{\circ}\text{C}$ (95 $^{\circ}\text{F}$).

5.3 Use of menu functions

Brief description of the operating principle:

The unit is operated using 5 keys. Their functions are:

Button	Section	Functions
← or OK	Display	– Switches from the measurement display to the main menu
	Menu	– Selects the menu item displayed
	Enter	– Applies an edited value or a selection
▲	Display	– temporarily switches to the alternative measurement display (if option installed)
	Menu	– Back
	Enter	– Increase value or browse selection – Note: – Press button 1 x = changes parameter / value by one; – Hold button = fast mode (numerical values only) – Display flashes: modified parameter/value – Steady display: original display/value
▼	Display	– temporarily switches to the alternative measurement display (if option installed)
	Menu	– Next
	Enter	– Reduce value or browse selection
ESC	Menu	– Move one level up
	Enter	– Return to menu Changes will not be saved!
F or Func		– Sets a menu to favourite. (Note: The favourite menu will also be activated with the menu locked!)

5.3.1 Lock Menu

Some menus can be locked to prevent inadvertently changing the settings of the unit. This requires setting a code. For information on setting up or disabling the menu lock please refer to "Global Settings" (*tOP*) under menu item *tOP* > *Loc*.

The menu lock is **not** enabled at the time of delivery, all menu items can be accessed.

With the menu locked, only the following menu items will be visible without entering the correct code:

Menu item	Explanation
<i>tOP</i> > <i>uni</i> <i>t</i>	Temperature unit selection (°C or °F).
F or Func.	Accessing the Favourites menu NOTICE! This menu may be one that is normally locked.

5.3.2 Overview of the menu items

When pressing the **OK** button in normal mode, the display will show the prompt *codE* if the menu is locked. Use the **▲** and **▼** buttons to enter the correct code and press **OK**.

If an incorrect code or no code is entered, the menu will not be unlocked and you will not be able to access all menu items.

If you forgot the password you can always enter master code 287 to access the menu; the menu will be unlocked.

The following image shows an overview of the menu structure.

Items with a dashed frame will only appear with the respective settings or with the respective status messages.

The factory defaults and settings ranges are specified in the overview as well as under the respective menu item. The factory defaults apply unless otherwise agreed.

You can cancel entries and menu selections without saving by pressing the **ESC** key.

Menu:

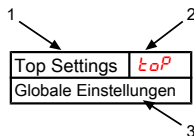

1. Menu designation
2. Display
3. Brief description

Parameter:

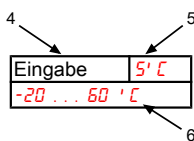

4. Value input
5. Factory preset
6. Parameter range

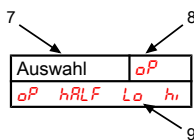

7. Selecting from the list of values
8. Factory preset
9. Parameter range/selection

Optional menu navigation:

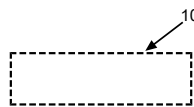

10. dashed box = Optional

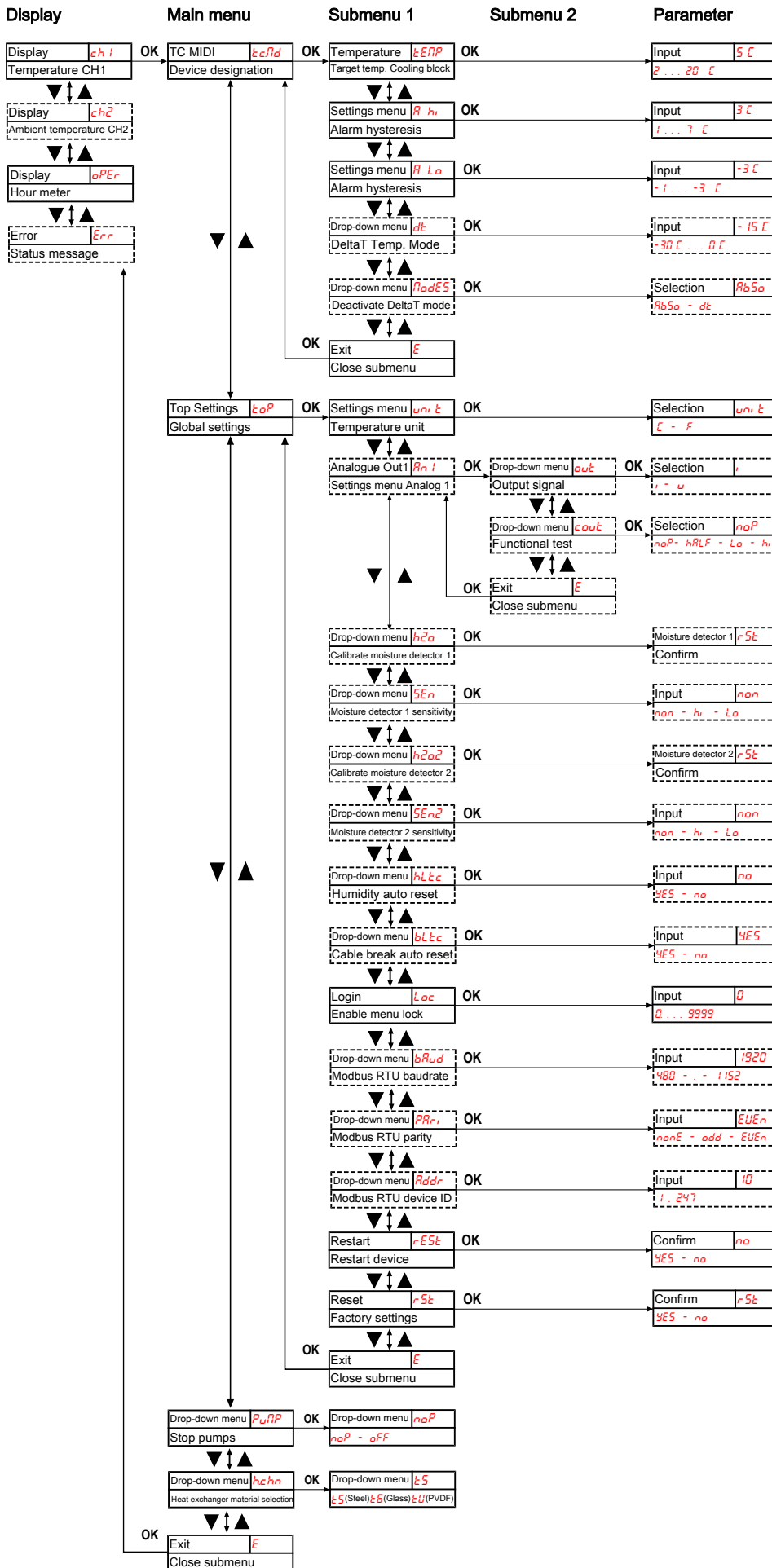

Fig. 1: Menu overview TC MIDI

5.4 Description of menu functions

5.4.1 Display menu

Block temperature display

Display → *chl*



Depending on the device state, the temperature will be displayed as a constant, flashing, or alternating with a status message.

Ambient temperature display

Display → *ch2*



The display is only available on devices with „Delta-T“ option. Depending on the device state, the temperature will be displayed as a constant, flashing, or alternating with a status message.

Operating hours /runtime display

Display → *oPEr*



Displays the operating hours of the unit. The runtime cannot be reset and can be output in various display formats. To view/exit the runtime, press the „Enter“ key.

- *yyMn* – display in years and months (default)
- *Mth* – display in months
- *WEEh* – display in weeks
- *dRYS* – display in days
- One month corresponds to 30 days. Press the „F“ key to switch between the display formats. The display will then first show the selected format as short text, then the duration.

Error code display

Display → *Err*



In the event of errors/malfunctions not related to operation, the error code indicates possible causes and solutions.

5.4.2 Main menu

Peltier Cooler TC-MIDI

Display → *tcPd*



This will take you to the cooler target temperature and the tolerance range setting (alarm threshold).

Global setting

Display → *toP* (ToP Settings)



This menu is used to configure the global cooler settings.

Peristaltic pump and sample gas pump

Display → *PuRP*

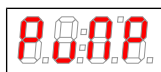

Switching the peristaltic pump and sample gas pump on and off.

Parameter range: *noP*, *oFF*

Factory setting: *noP*

Note: Status switches, "*PuRP*" flashes.

Heat exchanger material selection

Display → *hchh*



Heat exchanger material selection

Parameter range: *LS* (Steel), *LB* (Glass), *LU* (PVDF)

Factory setting: *LS* (cooler without heat exchanger), or respective material per configuration

Exit main menu

Display → *E*



Selecting this will return you to display mode.

5.4.3 Submenu 1

Target temperature

Display → Cooler → *LETP*



This setting determines the nominal temperature for the cooler temperature.

Parameter range: 2 °C to 20 °C (35.6 °F to 68 °F)

Factory setting: 5 °C (41 °F)

Note: If the temperature is changed the indicator may blink, until the new operating range has been reached.

This menu item is hidden if the keylock is enabled.

upper alarm limit

Display → Cooler → *RA hi* (Alarm high)

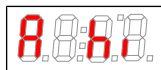

Here you can set the upper threshold for the visual signal and the alarm relay. The alarm limit is set based on the cooler temperature setting.

Parameter range: 1 °C to 7 °C (1.8 °F to 12.6 °F)

Factory setting: 3 °C (5.4 °F)

Note: This menu item is hidden if the keylock is enabled.

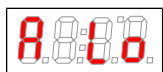
lower alarm limitDisplay → Cooler → *R Lo* (Alarm low)

Here you can set the lower threshold for the visual signal and the alarm relay. The alarm limit is set based on the cooler temperature setting.

Parameter range: -1 °C to -3 °C (-1.8 °F to -5.4 °F)

Factory setting: -3 °C (-5.4 °F)

Note: This menu item is hidden if the keylock is enabled.

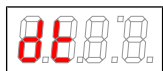
DeltaTDisplay → Cooler → *dt*

Here you can set the nominal difference with respect to ambient temperature.

Parameter range: -30 K...0 K

Factory setting: -15 K

Note: This menu will be hidden if the menu is locked.

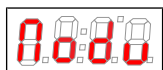
DeltaT modeDisplay → Cooler → *modu*

Here you can activate or deactivate DeltaT-mode.

Parameter range: *AbSo, dt*Factory setting: *AbSo* (normal operation mode)

Note: This menu will be hidden if the menu is locked.

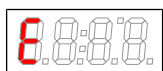
Exit submenu 1Display → Submenu → *E*

Selecting this will return you to the main menu.

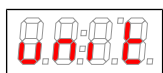
5.4.4 Submenu 1 (global settings)**Temperature unit**Display → *LoP* → *unit*

Used to select the temperature display unit.

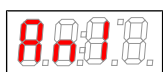
Parameter range: *C, F*Factory setting: *C***Analog output**Display → *LoP* → *An 1*

This submenu is used to specify the settings for analog output 1, see chapter Submenu 2 (Analog Output 1)

Note: This menu will be hidden if the menu is locked.

Calibrate moisture detector

Display → *LoP* → *h2o*

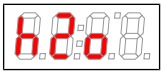

If a moisture detector is installed, calibration can now be performed. To do so, the unit must be flushed with dry gas.

Note:

Calibration was performed at the factory using ambient air. After replacing the moisture detector a calibration is again required.

Calibrating the moisture detector will set the menu *SEn* to *h1*.

This menu will be hidden if the menu is locked.

If the unit has multiple moisture detectors built in, they will be numbered in the menu. In this case, *h2o* indicates the first, *h2o2* the second moisture detector. The same applies to setting the sensor sensitivity in menu *SEn*.

Moisture detector sensitivity

Display → *LoP* → *SEn*

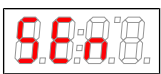

If moisture detectors are installed, the sensitivity can be reduced here.

Parameter range:

h1 : high sensitivity

Lo: low sensitivity

non: no moisture detector

Factory setting:

h1

Note:

This menu will be hidden if the menu is locked.

Moisture detector: manual or automatic reset following moisture ingress

Display → *LoP* → *hLtc*

(*hLtc* = humidity latch). The setting applies to all connected moisture detectors.



Specifies whether the moisture ingress message must be reset manually or will automatically be reset after the sensor dries.

Parameter range:

YES: The status will be indicated until the user restarts the device and the pumps will be disabled.

no: The status message will automatically be cleared/the pumps will be released again once moisture is no longer detected.

Factory setting:

no

Note:

This menu will be hidden if the menu is locked.

Moisture detector: error cleared automatically after cable break

Display → *LoP* → *bLtc*

(*bLtc* = broken wire latch). The setting applies to all connected moisture detectors.



Determines whether the cable break alarm must be reset manually or will automatically clear on valid measuring signal.

Parameter range:

YES: The status will be indicated until the user restarts the device. Clears the error, and the pumps will be deactivated.

no: The error message will disappear. The pumps will be switched on again once the moisture detector is reactivated again.

Factory setting:

YES

Note:

This menu will be hidden if the menu is locked.

Lock Menu

To protect the menu from unauthorised use, enter a value for the lock code. Menu items can then only be accessed after entering the correct code.

Display → *LoP* → *Loc*

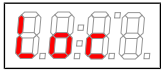

This setting will cancel/enable the menu lock.

Parameter range: 0 to 9999

Factory setting: 0 (keylock cancelled)

Note: This menu will be hidden if the menu is locked.

Modbus RTU baudrate

The default transfer rate is 19200 bps. This can be configured for the specific application within a defined range. The options in the display are listed in kbps (19.2 corresponds to 19200 bps). The properties of the digital interface are not affected when re-setting the device to its factory settings!

This menu item is only available on devices with "Digital output Modbus RTU" option.

Display → *LoP* → *bAud*

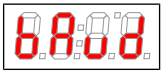

Determines the transfer rate for the digital interface.

Parameter range: *4.80*
9.60
19.20
38.40
57.60
115.2

Factory setting: *19.20*

Note: This menu will be hidden if the menu is locked.

Modbus RTU parity

The default parity is even/odd, options are odd parity, no parity. The number of stop bits is automatically set based on the respective setting. No parity uses two stop bits, otherwise it is one. The properties of the digital interface are not affected when re-setting the device to its factory settings!

This menu item is only available on devices with "Digital output Modbus RTU" option.

Display → *LoP* → *PRr1*

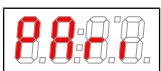

This setting restores the factory settings.

Parameter range: *nonE*
odd
EVEN

Factory setting: *EVEN*

Note: This menu will be hidden if the menu is locked.

Modbus RTU device ID

Selecting the device ID for communication via digital interface. The ID can be any within a defined range, the default is 10. The properties of the digital interface are not affected when resetting the device to its factory settings!

This menu item is only available on devices with "Digital output Modbus RTU" option.

Display → *LoP* → *Rddr*

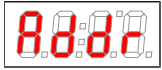

Defines the ID.

Parameter range: *1-247*

Factory setting: *10*

Note: This menu will be hidden if the menu is locked.

Restart

Display → *LoP* → *rESt*

(*rESt* = restart)



The device will restart, all settings are saved. All error messages will be reset. The moisture detector will be reset, irrespective of the settings in menus *h1Ec* and *h1Pa*.

Parameter range: *YES*: Restart. The display will show the software version for the device and returns to measurement display.
no: Exit menu without restarting.

Note: The user settings will be saved.

Factory settings

Display → *LoP* → *rSt*



This setting restores the factory settings.

Parameter range: *YES*: factory settings restored.
no: Exit menu without making changes.

Factory setting: *no*

Note: This menu will be hidden if the menu is locked.

Exit submenu 1

Display → Submenu → *E*



Selecting this will return you to the main menu.

5.4.4.1 Submenu 2 (Analog Output 1)

The analog output will display the actual cooler temperature. The menu items for the analog output are no available on devices with "Digital output Modbus RTU" option.

Signal behaviour

In normal mode (*noP*) the measuring point will output the actual temperature. For testing purposes you can generate constant values *hi*, *Lo* or *hRLF*. The analogue output will output a constant signal with a value as specified in the table.

Constant	Current output 4 – 20 mA	Voltage output 2 – 10 V
<i>hi</i>	20 mA	10 V
<i>hi</i>	12 mA	6 V
<i>Lo</i>	4 mA	2 V
<i>noP</i>	4 – 20 mA	2 – 10 V

After testing, the signal behaviour must be changed back to normal mode (*noP*).

Display → *LoP* → *An I* → *out*

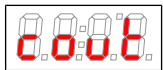

This setting determines how the analogue output will behave.

Parameter range: *noP* = Operation (normal mode), *hi*, *Lo*, *hRLF*

Factory setting: *noP*

Note: This menu will be hidden if the menu is locked.

Selection -> Output Signal

Display → *LoP* → *An I* → *out*



Select the type of output signal.

Parameter range: Status output 4... 20 mA

Status output 2...10 V

Factory setting:

Note: Disconnect meter before switching!

This menu item is hidden if the keylock is enabled.

Exit Submenu 2

Display → *LoP* → *An I* → *E*



Selecting this will return you to submenu 1.

5.4.5 Set favourite menu

Use the **F** or **Func** (function) key to set a favourite menu to later open it with just the push of a button.

- Open the menu you wish to set as the favourite. This menu can also be a lockable menu.
- Press the function key for more than 3 sec.
The current menu has been set as the favourite. The display will briefly show the message *Func*.
- Press **ESC** or *E* (Exit) to return to the display.

To now access the favourite menu, press the **F** or **Func** key.

NOTICE! The favourite menu can also be accessed if the menu is locked.

5.5 Using the Digital Interface

The digital interface on this device is a Modbus RTU protocol, which physically communicates via RS485 (2-wire). The cooler therefore takes on the role of the slave in communication.

The Modbus interface enables direct access to process and diagnostic data and parameters during operation.

5.6 Modbus Configuration

The settings below are the defaults; the parameters can be adjusted if the interface is enabled.

1 start bit

8 data bits

1 parity bits (configurable)

1 stop bit (*)

Baudrate: 19200 bps (configurable)

Device ID: 10 (configurable)

(*) The length of a Modbus frame is always 11 bit, configuring the interface at 0 data bits automatically changes the number of stop bits to 2.

5.7 Modbus Communication

Communication via Modbus RTU is always imitated by the master (request). The slave (typically) responds to the request with a response. A Modbus RTU frame for a request/response always has the following structure:

Address field (A)	Function code (FC)	Data	CRC
1 byte	1 byte	1 ... 252 bytes	2 bytes

Register addresses and data are transferred in Big Endian format.

Every register stands for a 16 bit value, with the information represented in various data types. The data type and required function code are assigned to the respective registers in the following tables.

To read/write data types with sizes larger than an individual register, multiple registers must be addressed.

Supported function codes:

Function code (FC)	FC values
Read Holding Registers	3
Write Multiple Registers	16

Data types:

Description	Number of bytes	Number of registers
Float	4	2
Int16	2	1
UInt16	2	1
Int32	4	2
UInt32	4	2

5.8 Modbus Register

Description	FC	Address	Access	Data type	Default	Min	Max	Selection	Resolution	Unit
Block temperature measurement	3	2000	R	Float	-	-	-	-	0.5	°C
Block temperature status	3	2002	R	Uint32	-	-	-	Bit 0 := Error Bit 1..15 := Reserved Bit 16 := Sensor not calibrated Bit 17 := Initialization/measurement invalid Bit 18 := Stabilisation phase Bit 19 := Load limit reached Bit 20 := Measurement outside target range Bit 21..31 := Not used	-	-
Ambient temperature measurement	3	2004	R	Float	-	-	-	-	0.5	°C
Ambient temperature status	3	2006	R	Uint32	-	-	-	Bit 0 := Error Bit 1..15 := Reserved Bit 16 := Sensor not calibrated Bit 17 := Initialization / measurement invalid Bit 18..31 := Not used	-	-
Block temperature setpoint	3, 16	5000	R/W	Float	5.0	3.0	20.0	-	0.5	°C
Positive alarm tolerance setpoint	3, 16	5002	R/W	Float	3.0	1.0	7.0	-	1.0	K
Negative alarm tolerance setpoint	3, 16	5004	R/W	Float	-3.0	-3.0	-1.0	-	1.0	K
Temperature difference Delta-T	3, 16	5008	R/W	Float	-15.0	-30.0	0.0	-	1.0	K
Enable/disable Delta T	3, 16	9001	R/W	Uint16	0	-	-	0 := Normal mode 1 := Delta-T control	1	-
Moisture detector signal store error	3, 16	9002	R/W	Uint16	2	-	-	1 := No 2 := Yes	-	-
Moisture alarm signal store	3, 16	9003	R/W	Uint16	1	-	-	1 := No 2 := Yes	-	-
Sensitivity moisture detector 1	3, 16	9004	R/W	Uint16	1 (with FF) 2 (without FF)	-	-	0 := Sensitivity low 1 := Sensitivity high 2 := Moisture detector inactive	-	-
Sensitivity moisture detector 2	3, 16	9005	R/W	Uint16	1 (with FF) 2 (without FF)	-	-	0 := Sensitivity low 1 := Sensitivity high 2 := Moisture detector inactive	-	-
Display unit selection	3, 16	9006	R/W	Uint16	1	-	-	1 := °C 2 := °F	-	-
Heat exchanger type selection	3, 16	9007	R/W	Uint16	2	-	-	2 := Steel 3 := Glass 4 := PVDF	-	-

Description	FC	Address	Access	Data type	Default	Min	Max	Selection	Resolution	Unit
De-/activate condensate pump(s)	3, 16	9008	R/W	Uint16	3	-	-	3 := Pump active 4 := Pump inactive	-	-
Modbus Baudrate selection	3, 16	9009	R/W	Uint16	3	-	-	1 := 4800 2 := 9600 3 := 19200 4 := 38400 5 := 57600 6 := 115200	-	-
Modbus Parity selection	3, 16	9010	R/W	Uint16	2	-	-	0 := None 1 := Odd 2 := Even	-	-
Modbus Device address selection	3, 16	9011	R/W	Uint16	10	1	247	-	1	-
Lock menu	3, 16	9012	R/W	Uint16	0	0	9999	-	1	-
TEST	3	9990	R	Uint32	12648430	-	-	-	1	-
TEST_UINT16	3, 16	9992	R/W	Uint16	206	0	65535	-	1	-
TEST_INT16	3, 16	9993	R/W	Int16	-206	-32768	32767	-	1	-
TEST_UINT32	3, 16	9994	R/W	Uint32	2766	0	4294967295	-	1	-
TEST_INT32	3, 16	9996	R/W	Int32	-2766	0x80000000	0x7fffffff	-	1	-
TEST_Float	3, 16	9998	R/W	Float	-10.5	-	-	-	-	-
Status register overview	3	10000	R	Uint16	0	-	-	Bit 0 := Status information register 10001 Bit n := Status information register 10000 + n + 1	-	-
Condition code register 1	3	10001	R	Uint16	0	-	-	Bit 0 := Device status Bit 1 := Device in error status Bit 2 := Target temperature range overrun Bit 3 := Target temperature range underrun Bit 4 := Bit 5 := Bit 6 := Moisture detector 1 connected Bit 7 := Moisture detector 2 connected	-	-
Condition code register 2	3	10002	R	Uint16	0	-	-	Bit 0 := Bit 1 := Bit 2 := Initialization phase Bit 3 := Bit 4 := Bit 5 := Bit 6 := FF1 moisture alarm Bit 7 := FF2 moisture alarm	-	-

Description	FC	Address	Access	Data type	Default	Min	Max	Selection	Resolution	Unit
Condition code register 3	3	10003	R	Uint16	0	-	-	Bit 0 := Peristaltic pumps deactivated Bit 1 := Bit 2 := Bit 3 := Bit 4 := Bit 5 := Bit 6 := Gas pump controller deactivated Bit 7 :=	-	-
Condition code register 4	3	10004	R	Uint16	0	-	-		-	-
Error register 1	3	10005	R	Uint16	0	-	-	Bit 0 := Display communication error Bit 1 := Controller communication error Bit 2 := Bit 3 := Controller configuration error Bit 4 := EEPROM regulator error Bit 5 := Bit 6 := Bit 7 := Gen. software error	-	-
Error register 2	3	10006	R	Uint16	0	-	-		-	-
Error register 3 - moisture detector 1	3	10007	R	Uint16	0	-	-	Bit 0 := Bit 1 := Bit 2 := Cable break Bit 3 := Bit 4 := Bit 5 := Bit 6 := Bit 7 :=	-	-
Error register 4 – moisture detector 2	3	10008		Uint16	0	-	-	Bit 0 := Bit 1 := Bit 2 := Cable break Bit 3 := Bit 4 := Bit 5 := Bit 6 := Bit 7 :=	-	-
Error register 5 - PT100.1	3	10009	R	Uint16	0	-	-	Bit 0 := General error Bit 1 := Short-circuit/temperature low Bit 2 := Cable break/temperature high Bit 3 := Measurement fluctuation Bit 4 :=	-	-

Description	FC	Address	Access	Data type	Default	Min	Max	Selection	Resolution	Unit
								Bit 5 := Bit 6 := Bit 7 :=		
Error register 6- PT100.2	3	10010	R	Uint16	0	-	-		-	-
Error register 7	3	10011	R	Uint16	0	-	-	-	-	-
Error register 8	3	10012	R	Uint16	0	-	-	-	-	-
Error register 9	3	10013	R	Uint16	0	-	-	-	-	-
Error register 10	3	10014	R	Uint16	0	-	-	-	-	-
Utilisation controller 1	3	10017	R	Unit16	-	0	100	-	10	%
Utilisation controller 2	3		R	Unit16	-	0	100	-	10	%
Device run time	3	10100	R	Float	-	0	-	-	6 min	h
Restart/ reset device	16	11000	W	Unit16	0x00	-	-	86 := Restart device 17:= Factory reset	-	-
Reset moisture detector 1	16	11002	W	Uint16	170	-	-	-	-	-
Reset moisture detector 2	16	11003	W	Uint16	170	-	-	-	-	-

Example:

Register 5000 = 0x1388

Read block temperature set values

	A	FC	Start register HI	Start register LO	No. register HI	No. register LO		CRC	CRC
Request	0x0A (10)	0x03 (3)	0x13	0x88	0x00 (0)	0x02 (2)		0x41	0xDE
	A	FC	No. of byte	DATA 3	DATA 2	DATA 1	Data 0	CRC	CRC
Response	0x0A (10)	0x03 (3)	0x04	0x40	0xA0	0x00	0x00	0x55	0x11

6 Maintenance

The base version of the cooler requires no special maintenance.

However, it may have different options depending on the cooler model. In this case the following routine maintenance is required:

- **Option peristaltic pump:** Checking hoses (see chapter Replacing the hoses of the peristaltic pump (option))
- **Filter option:** Checking the filter element (see chapter Replacing the filter element (option))
- **Option moisture detector:** Calibrating the moisture detector (see chapter Calibration of the moisture detector (option))
- **Option sample gas pump:** Checking valves for contamination. After 500 operating hours, tighten the screws for the mounting ring to 3 Nm. (see chapter Replacing sample gas pump inlet and outlet valves (optional))

During maintenance, remember:

- The equipment must be maintained by a professional familiar with the safety requirements and risks.
- Only perform maintenance work described in these operating and installation instructions.
- Observe the respective safety regulations and operating specifications when performing any type of maintenance.
- Always use genuine spare parts.
- For the option for high-purity water or oxygen, only use the explicitly designated replacement items with the suffix -H2 or -O2.

DANGER

Electrical voltage

Electrocution hazard.



- a) Disconnect the device from power supply.
- b) Make sure that the equipment cannot be reconnected to mains unintentionally.
- c) The device must be opened by trained staff only.
- d) Regard correct mains voltage.



DANGER

Toxic, corrosive gas/condensate

Sample gas/condensate may be hazardous to health.



- a) If necessary, ensure a safe gas/condensate discharge.
- b) Always disconnect the gas supply when performing maintenance or repairs.
- c) Protect yourself from toxic/corrosive gasses/condensate when performing maintenance. Wear appropriate protective equipment.



CAUTION

Health hazard if the heat exchanger leaks

The heat exchanger is charged with glycol-based coolant.

In the event of a heat exchanger leak:



- a) Avoid contact with the skin and eyes.
- b) In the event of a leak, do not restart the cooler under any circumstances. The cooler must be repaired by the manufacturer.

7 Service and repair

This chapter contains information on troubleshooting and correction should an error occur during operation.

Repairs to the unit must be performed by Bühler authorised personnel.

Please contact our Service Department with any questions:

Tel.: +49 (0) 2102-498955 or your agent

For more information on your custom maintenance and startup services, please visit: <https://www.buehler-technologies.com/service>

If the device is not functioning properly after correcting any malfunctions and switching on the power, it must be inspected by the manufacturer. Please send the equipment inside suitable packaging to:

Bühler Technologies GmbH

- Reparatur/Service -

Harkortstraße 29

40880 Ratingen

Germany

For devices for H_2/O_2 applications, seal the gas and condensate path or return it without any parts in contact with the medium.

Please also attach the completed and signed RMA decontamination statement to the packaging. We will otherwise be unable to process your repair order.

You can find the form in the appendix of these instructions, or simply request it by e-mailing:

service@buehler-technologies.com.

7.1 Troubleshooting















Problem/Malfunction	Possible cause	Action
Condensate inside the gas output	– Condensate trap full	– Empty condensate trap
	– Valve inside the automatic condensate drain may be stuck	– Flush in both directions
	– Cooler overload	– Maintain limits
Reduced gas flow rate	– Gas circuit clogged	– Remove and clean heat exchanger – if necessary, replace filter element
	– Condensate output iced over	– Send in unit
Excess temperature	– Operating point not yet reached	– Wait (max. 20 min)
	– Cooling output too low despite the cooler running	– Ensure the vents are not covered (heat buildup)
	– Flow rate too high/dew point too high/gas temperature too high	– Maintain limits / install pre-separator
	– Built-in fan stopped	– Check and replace if necessary
Temperature low	– Controller failure	– Send in cooler
Modbus communication error	– Bus connection fault	– Check electrical connections
	– Line termination fault	– Check bus line
	– Check bus configuration	– Check/reset configurator







7.1.1 Error messages on the display

If an error occurs, the display will read "Err". Press the "▲" button to show the error number(s).

Error messages will appear until the unit has been restarted or the error is cleared using the "Func" button. It can only be cleared if the cause for the error has been corrected.

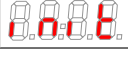
Causes / Action: The following is a list of the most common causes and actions for the respective error. If the actions listed do not resolve the problem, please contact Service.

Problem/malfunction	Possible cause	Action
No display	<ul style="list-style-type: none"> – No voltage – Loose connecting cable – Display failure 	<ul style="list-style-type: none"> – Check the supply cable – Check fuse – Check connections
 D1.02 (permanent)	(The software version for the display will appear). <ul style="list-style-type: none"> – Not communicating with the controller 	<ul style="list-style-type: none"> – Check connections
 Error	<ul style="list-style-type: none"> – An error has occurred 	<ul style="list-style-type: none"> – Read the error number as described above
 Error 01	<ul style="list-style-type: none"> – Controller malfunction 	<ul style="list-style-type: none"> – Clear error (temporary fault) – Disconnect from power for approx. 5 s – Contact service
 Error 03	<ul style="list-style-type: none"> – Microcontroller fault / MCP2 	<ul style="list-style-type: none"> – Contact service
 Error 04	<ul style="list-style-type: none"> – EEPROM error 	<ul style="list-style-type: none"> – Contact service
 Error 22	<ul style="list-style-type: none"> – Moisture detector 1 cable break 	<ul style="list-style-type: none"> – Check moisture detector line – Check moisture detector
 Error 32	<ul style="list-style-type: none"> – Moisture detector 2 cable break 	<ul style="list-style-type: none"> – Check moisture detector line – Check moisture detector
 Error 40	<ul style="list-style-type: none"> – General error temperature sensor 1 (block temperature) 	<ul style="list-style-type: none"> – Possible sensor failure
 Error 41	<ul style="list-style-type: none"> – Low temperature / short-circuit temperature sensor 1 	<ul style="list-style-type: none"> – Check temperature sensor connection
 Error 42	<ul style="list-style-type: none"> – Excess temperature / short-circuit temperature sensor 1 	<ul style="list-style-type: none"> – Check temperature sensor connection
 Error 43	<ul style="list-style-type: none"> – Measurement fluctuation temperature sensor 1 	<ul style="list-style-type: none"> – Check temperature sensor connection
 Error 50	<ul style="list-style-type: none"> – General error temperature sensor 2 (reference temperature Delta-T) 	<ul style="list-style-type: none"> – Possible sensor failure
 Error 51	<ul style="list-style-type: none"> – Low temperature / short-circuit temperature sensor 2 	<ul style="list-style-type: none"> – Check temperature sensor connection
 Error 52	<ul style="list-style-type: none"> – Excess temperature / short-circuit temperature sensor 2 	<ul style="list-style-type: none"> – Check temperature sensor connection
 Error 53	<ul style="list-style-type: none"> – Measurement fluctuation temperature sensor 2 	<ul style="list-style-type: none"> – Check temperature sensor connection

Status text	Possible cause	Action
 H2o.1	– Moisture alarm moisture detector 1	– Dry – Check condensate trap
 H2o.2	– Moisture alarm moisture detector 2	– Dry – Check condensate trap
 init	– Initialisation phase	– Wait
 PuMP	– Pumps deactivated	– Reactive pumps via menu
 dt	Active Delta T control only: The block temperature is outside the defined temperature range. – Cooler is still in the "break-in phase" – Fluctuating ambient temperature – Insufficient cooling capacity	– Wait to see if the target temperature will be reached – Check the ambient temperature / power supplied – Process-related: Adjust alarm limits
 (Flashing)	– Excess/low temperature	– see chapter "Troubleshooting"

7.2 Safety instructions

- The device must be operated within its specifications.
- All repairs must be carried out by Bühler authorised personnel only.
- Only perform modifications, servicing or mounting described in this manual.
- Only use original spare parts.

For sample gas coolers with stainless steel heat exchangers for O₂ applications (suffix -O2), there are special requirements for avoiding contamination when carrying out maintenance and repair work:

Only use cleaned and undamaged tools. We recommend cleaning with a lint-free cloth, ideally pre-soaked with a mixture of isopropanol and demineralised water for residue-free degreasing.

Only use cleaned, original spare parts (see sections Spare Parts and [Spare parts and accessories for cooler with -H2/-O2 heat exchanger](#) [> page 40]).

Do not use any parts whose original packaging is damaged.

The use of compressed air is only permitted if it corresponds to at least class 2 in accordance with ISO 8573-1:2010.

DANGER

Electrical voltage

Electrocution hazard.

- Disconnect the device from power supply.
- Make sure that the equipment cannot be reconnected to mains unintentionally.
- The device must be opened by trained staff only.
- Regard correct mains voltage.



DANGER

Toxic, corrosive gas/condensate

Sample gas/condensate may be hazardous to health.

- If necessary, ensure a safe gas/condensate discharge.
- Always disconnect the gas supply when performing maintenance or repairs.
- Protect yourself from toxic/corrosive gasses/condensate when performing maintenance. Wear appropriate protective equipment.



CAUTION**Health hazard if the heat exchanger leaks**

The heat exchanger is charged with glycol-based coolant. In the event of a heat exchanger leak:

- a) Avoid contact with the skin and eyes.
- b) In the event of a leak, do not restart the cooler under any circumstances. The cooler must be repaired by the manufacturer.

7.3 Cleaning and removal of the heat exchanger

Heat exchangers only need to be replaced or maintained if clogged or damaged. If they are clogged, we recommend checking whether using a filter will prevent this in future.

For applications with high-purity acid or hydrogen, we recommend cleaning in accordance with current application-specific standards or using an original replacement heat exchanger.

- Close gas supply.
- Switch off device and disconnect all plugs (e.g. status output connector, supply input, etc.).
- Disconnect gas connections and condensate drain.
- Pull the heat exchanger up and out.
- Clean cleaning nest (hole inside the cooler block), as the heat exchangers are installed with silicone grease.
- Purge the heat exchanger until all contaminants have been removed.
- Lubricate the cooled external surface with silicone grease.
- Reinsert the heat exchanger into the cooling nest with a rotating motion.
- Reconnect the gas supply and condensate drain. The gas inlet is marked red.
- Restore power/gas supply and wait until the unit is ready for operation.
- Open gas supply.

7.4 Replacing the fuse of the cooler

- Close gas supply.
- Switch off and unplug the device.
- If necessary, disconnect moisture detector from filter or adapter.
- Loosen the fixing bolts for the hood.
- Carefully remove the hood. The hood has parts which protrude inward and could cause damage.
- **The display module is attached to the front cover and connected to the electronics on the base plate. The plug connection can be removed.**
- **The sample gas or condensate pump is connected to the electronics. These cannot be disconnected.**
- The fuse is located on the board under a plastic cap. Replace micro-fuse and put the cap back on. Please note the mains voltage in order to select the correct micro-fuse.
- Reconnect the display plug connection and reattach the hood. Screw in fixing screws.
- Restore the power and gas supply.

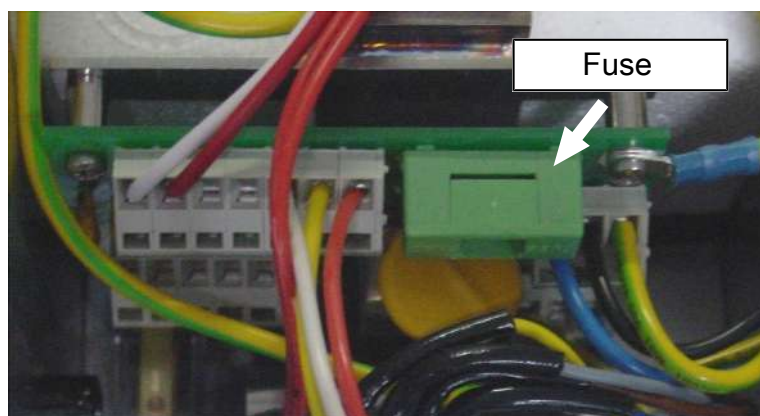

7.5 Replacing the hoses of the peristaltic pump (option)

- Turn off gas supply.
- Switch the device off and disconnect power supply.
- Remove the supplying and draining hoses from the pump (**Take care of the safety instructions!**).
- Loosen the centre knurled screw but do not remove it. Push the screw downwards.
- Pull off the cover.
- Pull the connections sideways and remove the hose.
- Replace the hose and remount the pump in reverse order.
- Reconnect power supply.

7.6 Replacing the filter element (option)

CAUTION



Gas leakage

The filter should not be dismantled under pressure.
Don't use damaged parts again.

- Close the gas supply.
- Switch off and unplug the device.
- Pull the bracket, holding on to the filter glass.
- Whilst holding the filter head, move the glass back and forth and carefully remove downward.
- Remove the filter element and insert a new one.
- Check for leaks and replace, if necessary.
- Whilst holding the filter head, move the glass back and forth and carefully reattach the filter head, attach the bracket, and ensure it is seated securely.
- Restore the power and gas supply.

NOTICE! Please observe legal regulations when disposing of filter elements.

7.7 Drying of the moisture detector (option)

The moisture detector must be dried if moisture enters.

- Close the gas supply.
- Switch off and unplug the device.
- Loosen the swivel nut for the moisture detector connection line and disconnect the line.
- Unscrew the moisture detector counter-clockwise and remove.
- Dry moisture detector.
- Reinsert the moisture detector and carefully tighten the screw connection.
- Connect the connection line and tighten the swivel nut.
- Restore the power and gas supply.

7.8 Calibration of the moisture detector (option)

- When replacing the moisture detectors, they must be recalibrated.
- Be sure dry gas flows through the cooler.
- Select cooler menu and confirm.

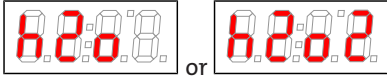

- Select menu item moisture detector.



- The display shows (Reset).
- Confirm the display to calibrate the moisture detectors.

For a detailed overview of menu navigation, refer to chapter "Operation and Control".

7.9 Replacing sample gas pump inlet and outlet valves (optional)

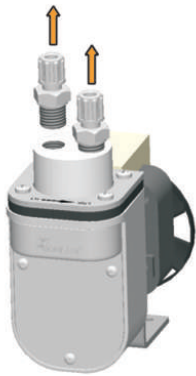

First detach the screw connections.

Unscrew the inlet or outlet valve with a wide slot screwdriver.

Attention: The PVDF and PVDF with bypass valve pump bodies already have PTFE gaskets installed in the gas inlets and outlets. These are also included in the valve spare parts kit. Remove the old gaskets before installing the new ones.

The inlet and outlet valves are identical. Their installation position determines the function. As shown in the image, the valves are blue on one side and black on the other. The valves are further marked "IN" or for inlet and "OUT" for outlet.

Inlet valve



Outlet valve

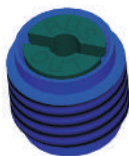

To assemble the sample gas pump, perform the steps in reverse order. When tightening the inlet and outlet valves be sure to observe the required tightening torque of max. 1 Nm. **CAUTION! Tightening the valves more will permanently deform the pump body, requiring replacement.**

When installing the screw connection, ensure the connection is tight.

7.10 Replacing the O-ring on the bypass valve (optional)

- Loosen the two screws on the valve plate and carefully remove the entire unit.
- Coat the new O-ring with suitable O-ring grease (min. operating temperature 145 °C, e.g. Fluoronox S90/2) and install in the spindle.
- Carefully insert the entire unit into the pump body while turning and tighten screws.

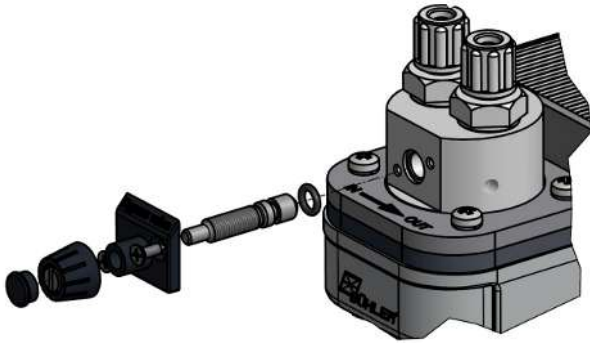

7.11 Replacing the bellow (optional)

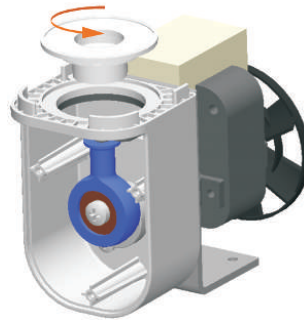
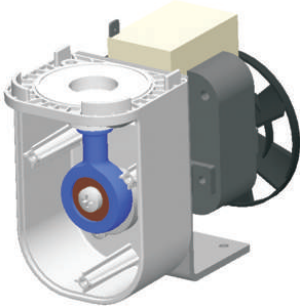

To replace the bellow carefully unscrew it from the connecting rod counter clockwise. Be sure not to lose any installed shims. Before reinstalling the bellow be sure it is not damaged. Reinstall hand tight in reverse order.

7.12 Spare Parts

Please also specify the model and serial number when ordering parts.

Upgrade and expansion parts can be found in our catalog.

Available spare parts:

Item no.	Description
9100100007	Display module MCD400
9100030265	Modbus RTU interface module
9144050079	Connecting cable controller board display module
9144051038	Modbus RTU interface module connecting cable
9100130380	Microcontroller board MCP2.2
9100011187	Controller board
9100010185	Power board
9110000020	Sample gas cooler micro-fuse 230 V, 5 x 20 mm, 3.15 A, delayed action
9110000063	Sample gas cooler micro-fuse 115 V, 5 x 20 mm, 6.3 A, delayed action
4011000	Flow adapter type G, PVDF G1/4
40110001	Flow adapter type NPT, PVDF NPT 1/4"
4011005	Flow adapter type G, stainless steel, G 1/4
40110051	Flow adapter type NPT, stainless steel, NPT 1/4"
4111100	Moisture detector FF-3-N, without cable
9144050081	Moisture detector connection cable, 300 mm
9144050086	Moisture detector connection cable, 520 mm
4150799	Filter AGF-PV-30-F2-L, G1/4
41507991	Filter AGF-PV-30-F2-L, NPT 1/4"

7.12.1 Consumables and accessories

Item no.	Description
4510008	Automatic condensate drain AK 5.2 (pressure operation only)
4510028	Automatic condensate drain AK 5.5 (pressure operation only)
4410004	Automatic condensate drain AK 20 (pressure operation only)
4410001	Automatic condensate drain 11 LD V 38 (pressure operation only)
9144050038	Cable for cooler temperature analog output 4 m
41020050	Filter element F2-L; 2-pack
4410005	Condensate trap GL1, 0.4 L
44920035012	Condensate pump replacement hose, Tygon (Norprene), angled hose nipple
44920035016	Condensate pump replacement hose, Tygon (Norprene), angled hose nipple and screw connection (metric)
44920035017	Condensate pump replacement hose, Tygon (Norprene), angled hose nipple and screw connection (US)
4228003	Bellow for P1 pump
9009398	O-ring for bypass P1 pump
4228066	Set inlet/outlet valves 70 °C for P1 pump
see data sheet 420011	Sample Gas Pumps P1
see data sheet 450020	CPsingle, CPdouble peristaltic condensate pumps

7.12.2 Spare parts and accessories for cooler with -H2/-O2 heat exchanger

Item no.	Description
4410001 (see data sheet 450005)	Automatic condensate drain 11 LD V 38 ¹⁾
4410001-O2 (see data sheet 450005)	Automatic condensate drain 11 LD V 38 optimised for oxygen
see data sheet 400016	Stainless steel pipe fittings for high-purity oxygen applications

¹⁾ For use with high hydrogen concentrations max. 1.5 bar overpressure.

8 Disposal

The heat exchanger is charged with glycol-based coolant.

The applicable national laws must be observed when disposing of the products. Disposal must not result in a danger to health and environment.

The crossed out wheelee bin symbol on Bühler Technologies GmbH electrical and electronic products indicates special disposal notices within the European Union (EU).



The crossed out wheelee bin symbol indicates the electric and electronic products bearing the symbol must be disposed of separate from household waste. They must be properly disposed of as waste electrical and electronic equipment.

Bühler Technologies GmbH will gladly dispose of your device bearing this mark. Please send your device to the address below for this purpose.



We are obligated by law to protect our employees from hazards posed by contaminated devices. Therefore please understand that we can only dispose of your waste equipment if the device is free from any aggressive, corrosive or other operating fluids dangerous to health or environment. **Please complete the "RMA Form and Decontamination Statement", available on our website, for every waste electrical and electronic equipment. The form must be applied to the packaging so it is visible from the outside.**

Please return waste electrical and electronic equipment to the following address:

Bühler Technologies GmbH
WEEE
Harkortstr. 29
40880 Ratingen
Germany

Please also observe data protection regulations and remember you are personally responsible for the returned waste equipment not bearing any personal data. Therefore please be sure to delete your personal data before returning your waste equipment.

9 Appendices

9.1 Gas cooler technical data

TC-MIDI

Gas Cooler Technical Data				
Ready for operation	after max. 10 minutes			
Ambient temperature	5 °C to 60 °C			
Gas outlet dew point preset:	5 °C			
adjustable:	2 °C...20 °C or Delta T control			
IP rating	IP 20			
Mechanical load	Tested based on DNV-GL CG0339 vibration class A (0.7g) ¹⁾ 2 Hz-13.2 Hz amplitude ± 1.0 mm 13.2 Hz -100 Hz acceleration			
Housing	Stainless steel, brushed			
Packaging dimensions	approx. 350 x 220 x 220 mm			
Weight incl. heat exchanger	approx. 11.5 kg approx. 15 kg at full expansion stage			
Electrical data	Unit without add-on		Unit with add-on (P1.x + peristaltic pump)	
	230 V AC	115 V AC	230 V AC	115 V AC
	+5/-10%	+5/-10%	+5%	+5%
	50/60 Hz	50/60 Hz	50 Hz	60 Hz
	1.2 A	2.4 A	1.8 A	3.6 A
	200 W / 280 VA		290 W / 420 VA	
Status output switching capacity	max. 250 V AC, 150 V DC 2 A, 50 VA, potential-free			
Electrical Connections	Plug per EN 175301-803			
Gas connections and condensate outlet	Heat exchanger see table "Heat Exchanger Overview" Filter, moisture detector adapter G1/4 or NPT 1/4"			
Parts in contact with media				
Filter:	see "Technical Data - Options"			
Moisture detector:	see "Technical Data - Options"			
Heat exchanger:	see table "Heat Exchanger Overview"			
Peristaltic pump:	see "Technical Data - Options"			
Sample gas pump:	see "Technical Data - Options"			
Tubing:	PTFE/Viton			

¹⁾ not in conjunction with add-on sample gas pump

TC-MIDI with -H2/-O2 heat exchanger

Gas cooler technical data

Ready for operation	after max. 10 minutes	
ambient temperature	5 °C to 60 °C	
Gas outlet dew point preset:	5 °C	
adjustable:	2 °C...20 °C	
IP rating	IP 20	
Mechanical load	Tested based on DNV-GL CG0339 vibration class A (0.7 g) 2 Hz-13.2 Hz amplitude ± 1.0 mm 13.2 Hz -100 Hz acceleration	
Housing	Stainless steel, brushed	
Packaging dimensions	approx. 350 x 220 x 220 mm	
Weight incl. heat exchanger	approx. 12 kg	
Electrical data	Unit without add-on	
	230 V AC	115 V AC
	+5/-10%	+5/-10%
	50/60 Hz	50/60 Hz
	1.2 A	2.4 A
	200 W / 280 VA	
Status output switching capacity	max. 250 V AC, 150 V DC 2 A, 50 VA, potential-free	
Electrical Connections	Plug per EN 175301-803	
Parts in contact with media Heat exchanger:	see table "Heat Exchanger Overview"	

TC-MIDI+

Gas Cooler Technical Data				
Ready for operation	after max. 10 minutes			
Ambient temperature	5 °C to 60 °C			
Gas outlet dew point preset:	5 °C			
adjustable:	2 °C...20 °C			
IP rating	IP 20			
Mechanical load	Tested based on DNV-GL CG0339 vibration class A (0.7g) ¹⁾ 2 Hz-13.2 Hz amplitude ± 1.0 mm 13.2 Hz -100 Hz acceleration			
Housing	Stainless steel, brushed			
Packaging dimensions	approx. 350 x 220 x 220 mm			
Weight incl. heat exchanger	approx. 12 kg approx. 15.5 kg at full expansion stage			
Electrical data	Unit without add-on		Unit with add-on (P1.x + peristaltic pump)	
	230 V AC	115 V AC	230 V AC	115 V AC
	+5/-10%	+5/-10%	+5%	+5%
	50/60 Hz	50/60 Hz	50 Hz	60 Hz
	1.2 A	2.4 A	1.8 A	3.6 A
	200 W / 280 VA		290 W / 420 VA	
Status output switching capacity	max. 250 V AC, 150 V DC 2 A, 50 VA, potential-free			
Electrical Connections	Plug per EN 175301-803			
Gas connections and condensate outlet	Heat exchanger see table "Heat Exchanger Overview" Filter, moisture detector adapter G1/4 or NPT 1/4"			
Parts in contact with media				
Filter:	see "Technical Data - Options"			
Moisture detector:	see "Technical Data - Options"			
Heat exchanger:	see table "Heat Exchanger Overview"			
Peristaltic pump:	see "Technical Data - Options"			
Sample gas pump:	see "Technical Data - Options"			
Tubing:	PTFE/Viton			

¹⁾ not in conjunction with add-on sample gas pump

9.2 Technical Data - Options

Analogue Output Cooler Temperature Technical Data

Signal	4-20 mA or 2-10 V corresponds to -20 °C to +60 °C cooler temperature
Connection	M12x1 plug, DIN EN 61076-2-101

Digital interface technical data

Signal	Modbus RTU (RS-485)
Connection	M12x1 connector, DIN EN 61076-2-101

Technical Data Peristaltic Pumps CPsingle / CPdouble

Ambient temperature	0 °C to 60 °C
Flow rate	0.3 L/h (50 Hz) / 0.36 L/h (60 Hz) with standard hose
Vacuum inlet	max. 0.8 bar
Pressure inlet	max. 1 bar
Outlet pressure	1 bar
Hose	4 x 1.6 mm
Condensate outlet	Hose nipple Ø6 mm Screw connection 4/6 (metric), 1/6"-1/4" (US)
Protection class	IP 40
Materials	
Hose:	Norprene (Standard), Marprene, Fluran
Connections:	PVDF

Technical Data Sample Gas Pump P1

Ambient temperature	0 °C to 50 °C
Operating pressure	max. 1,3 bar abs.
Nominal outlet	280 l/h (at p = 1 bar abs.)
Materials in contact with media vary by configuration	PTFE, PVDF, 1.4571, 1.4401, Viton, PFA

Technical Data Filter AGF-PV-30-F2-L

Ambient temperature	3 °C to 100 °C
max. operating pressure with filter	4 bar
Filter surface	125 cm ²
Filter fineness	2 µm
Dead volume	108 ml
Materials	
Filter:	PVDF, Duran glass (parts in contact with mediums)
Seal:	Viton
Filter element:	sintered PTFE

Technical Data FF-3-N Moisture Detector

Ambient temperature	3 °C to 50 °C
max. operating pressure with FF-3-N	2 bar
Material	PVDF, PTFE, epoxy resin, stainless steel 1.4571, 1.4576

9.3 Flow diagrams

TC-MIDI

Standard hoses each gas path

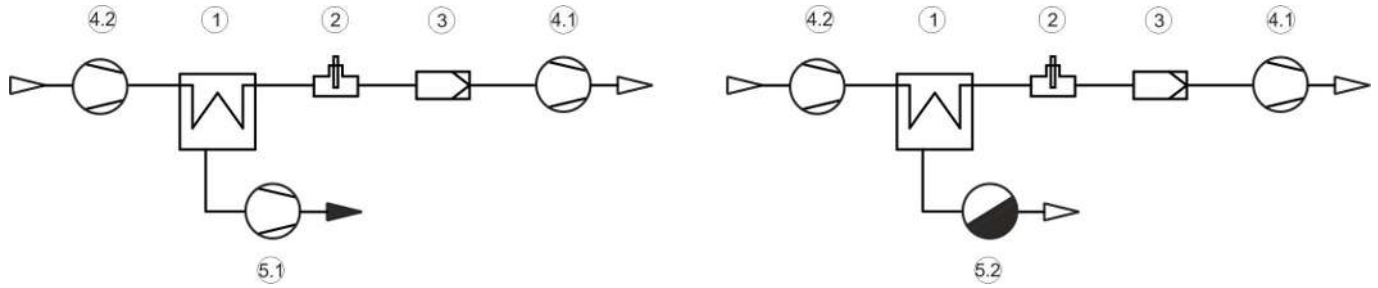

1 Cooler	4.2 Sample Gas Pump, Pressure Operation (Optional)
2 Moisture detector (optional)	5.1 Condensate pump (optional)
3 Filter (optional)	5.2 Automatic Condensate Drain, Pressure Operation (Optional)
4.1 Sample Gas Pump, Suction Operation (Optional)	

TC-MIDI+

1 gas path in series

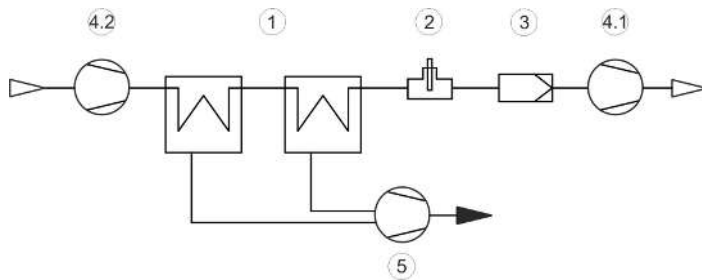

1 Cooler	4.1 Sample Gas Pump, Suction Operation (Optional)
2 Moisture detector (optional)	4.2 Sample Gas Pump, Pressure Operation (Optional)
3 Filter (optional)	5 Condensate pump (optional)

9.4 Dimensions (mm)

TC-MIDI

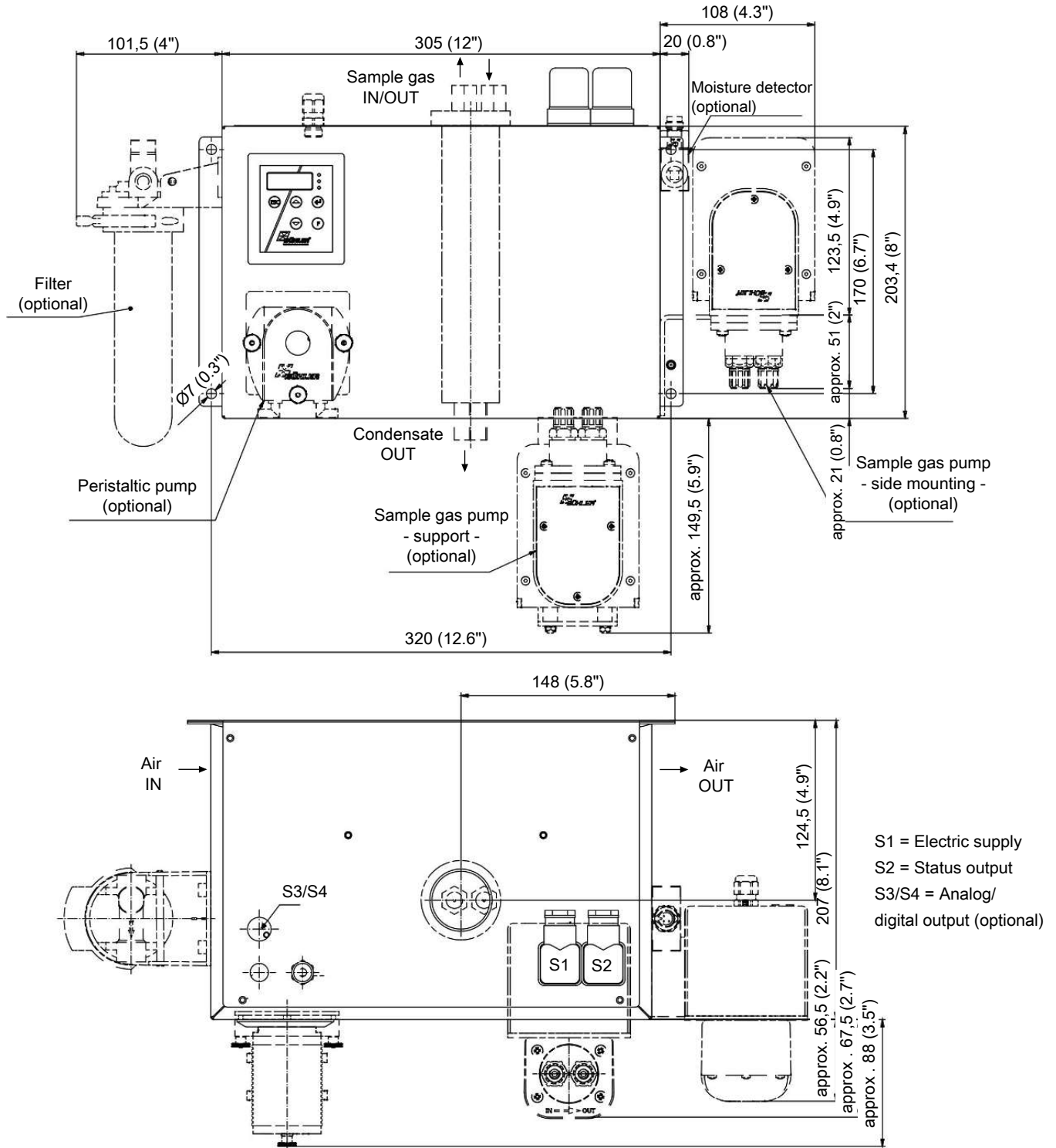

TC-MIDI with -H2/-O2 heat exchanger

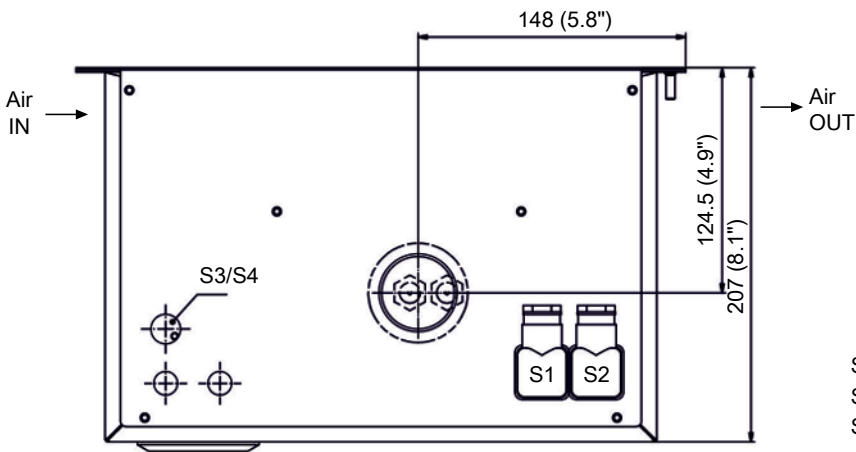
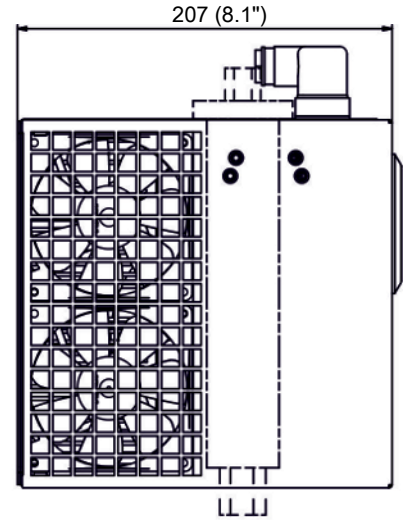
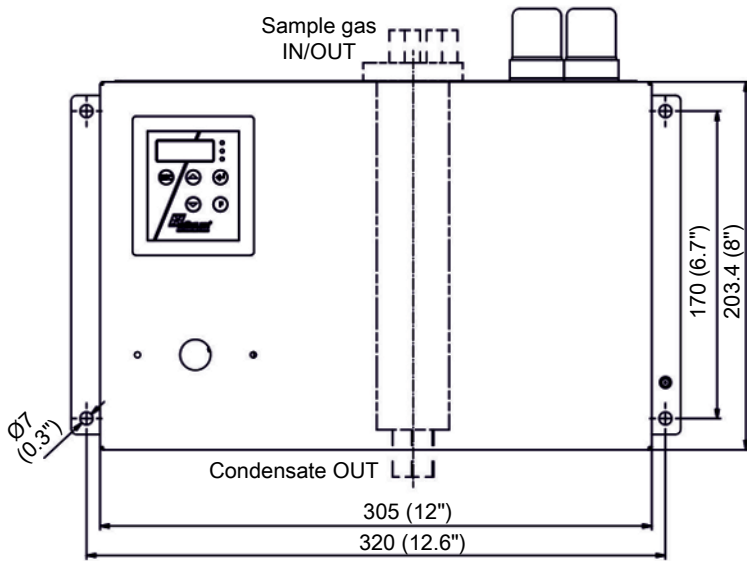

- S1 = Electric supply
- S2 = Status output
- S3/S4 = Analog/digital output (optional)

TC-MIDI+

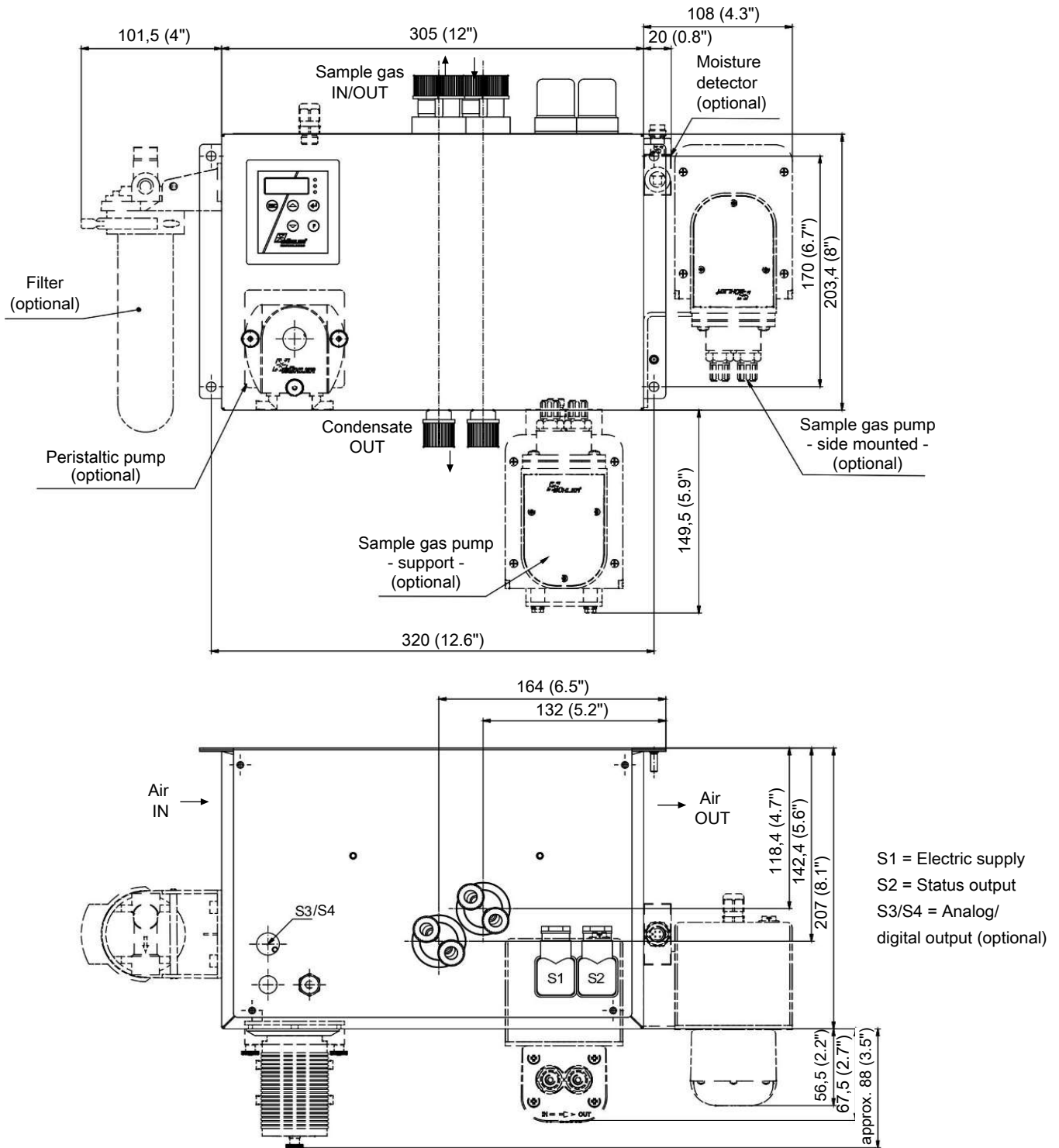

S1 = Electric supply
 S2 = Status output
 S3/S4 = Analog/
 digital output (optional)

9.5 Performance data

TC-MIDI

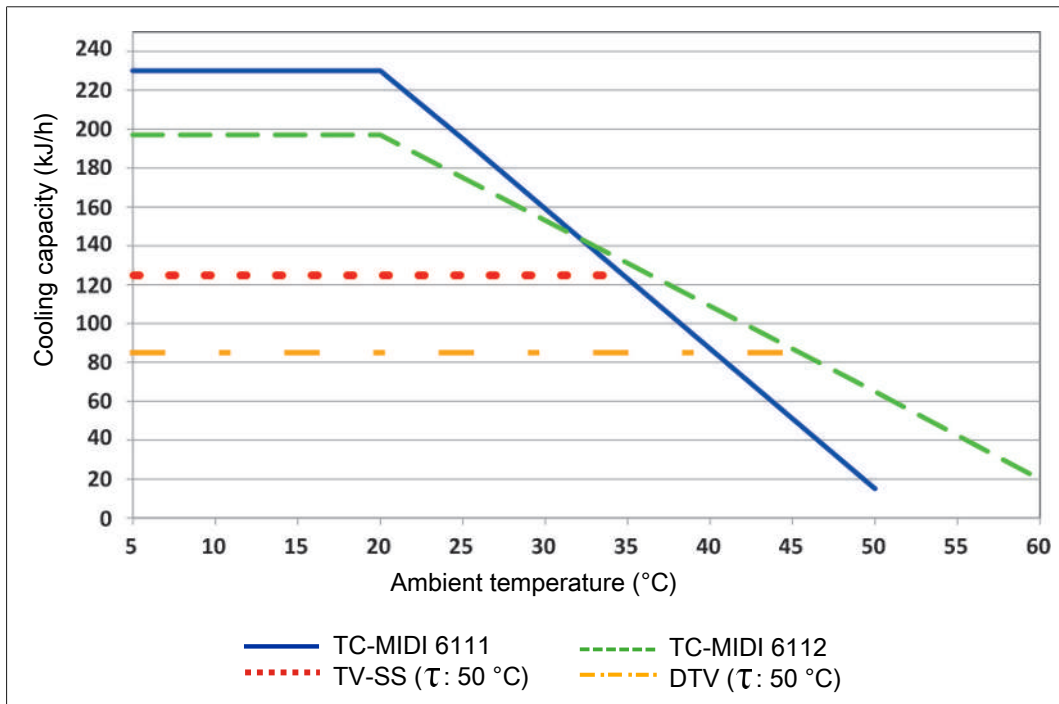

Note: The limit curves for the heat exchangers exchanger apply to a dew point of 50 °C.

TC-MIDI with -H2/-O2 heat exchanger

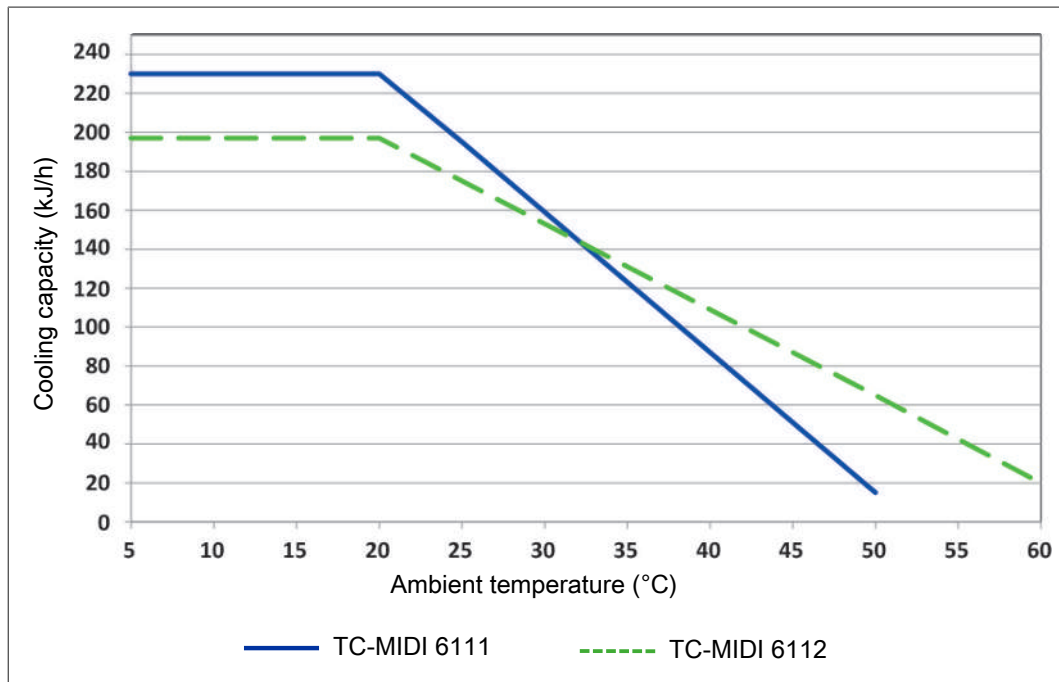

Note: The limit curves for the heat exchangers exchanger apply to a dew point of 50 °C.

TC-MIDI+

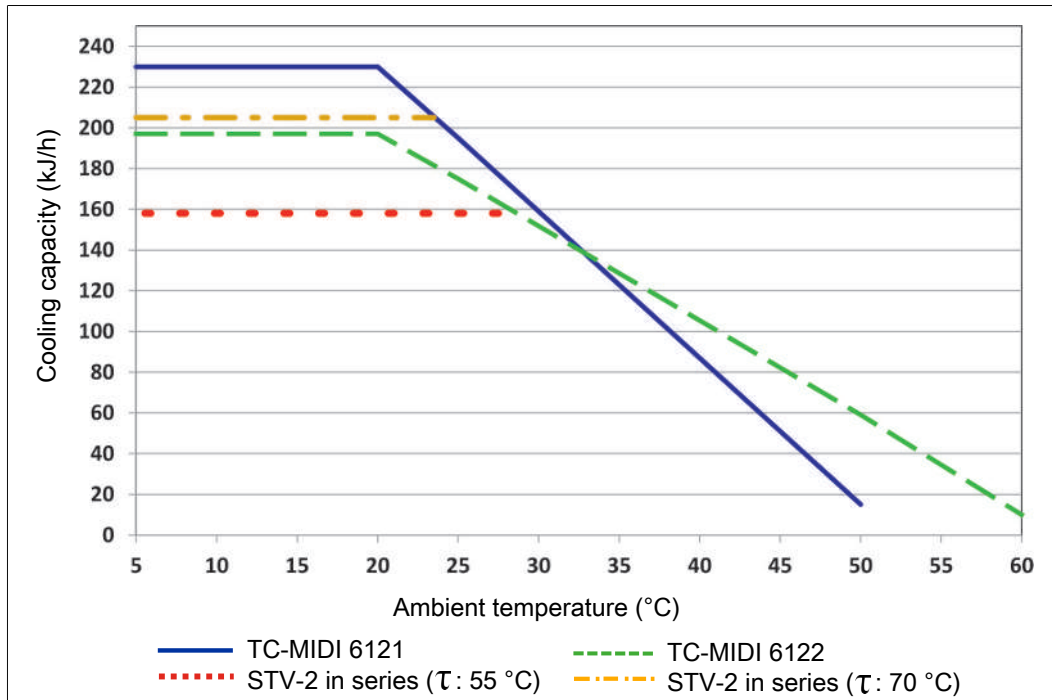

Note: The capacity of STG-2 heat exchangers is equivalent to the maximum cooling capacity of the cooler.

9.6 Heat exchanger

9.6.1 Heat exchanger description

TC-MIDI

The energy content of the sample gas and the required cooling capacity of the gas cooler is determined by three parameters: gas temperature ϑ_G , dew point τ_e (moisture content) and volume flow v . The outlet dew point rises with increasing energy content of the gas. The approved energy load from the gas is therefore determined by the tolerated rise in the dew point.

The following limits are specified for a standard operating point of $\tau_e = 50$ °C and $\vartheta_G = 70$ °C. The maximum volume flow v_{\max} in NI/h of cooled air is indicated, so after moisture has condensed.

If the values fall below τ_e and ϑ_G , the flow v_{\max} may be increased. For example, on the TG heat exchanger the parameter triple $\tau_e = 40$ °C, $\vartheta_G = 70$ °C and $v = 425$ NI/h may also be used in place of $\tau_e = 50$ °C, $\vartheta_G = 70$ °C and $v = 345$ NI/h.

Please contact our experts for clarification or refer to our design program.

TC-MIDI+

The energy content of the sample gas and the required cooling capacity of the gas cooler is determined by three parameters: gas temperature ϑ_G , dew point τ_e (moisture content) and volume flow v . The outlet dew point rises with increasing energy content of the gas. The approved energy load from the gas is therefore determined by the tolerated rise in the dew point.

The following limits are specified for a standard operating point of $\tau_e = 50$ °C and $\vartheta_G = 70$ °C. The maximum volume flow v_{\max} in NI/h of cooled air is indicated, so after moisture has condensed.

If the values fall below τ_e and ϑ_G , the flow v_{\max} may be increased. For example, on the STG-2 heat exchanger the parameter triple $\tau_e = 40$ °C, $\vartheta_G = 70$ °C and $v = 575$ NI/h may also be used in place of $\tau_e = 50$ °C, $\vartheta_G = 70$ °C and $v = 320$ NI/h.

Please contact our experts for clarification or refer to our design program.

9.6.2 Heat exchanger overview

TC-MIDI

Heat exchanger	TS TS-I ²⁾	TG TG-I ²⁾	TV TV-I ²⁾	DTS (DTS-6 ³⁾) DTS-I (DTS-6-I ³⁾) ²⁾	DTG DTG-I ²⁾	DTV ³⁾ DTV-I ²⁾³⁾
Materials in contact with media	Stainless steel	Glass PTFE	PVDF	Stainless steel	Glass PTFE	PVDF
Flow rate v_{\max} ¹⁾	500 L/h	400 L/h	235 L/h	2 x 250 L/h	2 x 200 L/h	2 x 160 L/h
Inlet dew point $\tau_{e,\max}$ ¹⁾	80 °C	80 °C	65 °C	80 °C	65 °C	65 °C
Gas inlet temperature $\vartheta_{G,\max}$ ¹⁾	180 °C	140 °C	140 °C	180 °C	140 °C	140 °C
Max. cooling capacity Q_{\max}	450 kJ/h	230 kJ/h	120 kJ/h	450 kJ/h	230 kJ/h	185 kJ/h
Gas pressure p_{\max}	160 bar	3 bar	3 bar	25 bar	3 bar	2 bar
Pressure drop Δp ($v=150$ L/h)	8 mbar	8 mbar	8 mbar	5 mbar each	5 mbar each	15 mbar each
Dead volume V_{tot}	69 ml	48 ml	129 ml	28 / 25 ml	28 / 25 ml	21 / 21 ml
Gas connections (metric)	G1/4	GL 14 (6 mm) ⁴⁾	DN 4/6	6 mm tube	GL14 (6 mm) ⁴⁾	DN 4/6
Gas connections (US)	NPT 1/4"	GL 14 (1/4") ⁴⁾	1/4"-1/6"	1/4" tube	GL14 (1/4") ⁴⁾	1/4"-1/6"
Condensate out connections (metric)	G3/8	GL 25 (12 mm) ⁴⁾	G3/8	Tube 10 mm (6 mm)	GL18 (10 mm) ⁴⁾	DN 5/8
Condensate out connections (US)	NPT 3/8"	GL 25 (1/2") ⁴⁾	NPT 3/8"	Tube 3/8" (1/4")	GL18 (3/8") ⁴⁾	3/16"-5/16"

¹⁾ Max. cooling capacity of the cooler must be considered.

²⁾ Models marked I have NPT threads or US tubes, respectively.

³⁾ Condensate drain only possible with condensate pump.

⁴⁾ Gasket inside diameter.

TC-MIDI with -H2/-O2 heat exchanger

Heat exchanger	TS-H2/-O2 TS-I-H2/-O2 ²⁾	DTS-H2/-O2 DTS-I-H2/-O2 ²⁾
Materials in contact with media	Stainless steel	Stainless steel
Flow rate v_{\max} ¹⁾	500 l/h	2x 250 l/h
Inlet dew point $\tau_{e,\max}$ ¹⁾	80 °C	80 °C
Gas inlet temperature $\vartheta_{G,\max}$ ¹⁾	180 °C	180 °C
Max. cooling capacity Q_{\max}	450 kJ/h	450 kJ/h
Gas pressure p_{\max}	1.5 bar	1.5 bar
Pressure drop Δp ($v=150$ l/h)	8 mbar	5 mbar each
Dead volume V_{dead}	69 ml	28/25 ml
Gas connections (metric)	G1/4	6 mm tube
Gas connections (US)	NPT 1/4"	1/4" tube
Condensate out connection (metric)	G3/8	Tube 10 mm (6 mm)
Condensate out connection (US)	NPT 3/8"	Tube 3/8" (1/4")

¹⁾ Max. cooling capacity of the cooler must be considered.

²⁾ Models marked I have NPT threads or US tubes.

TC-MIDI+

Heat exchanger	2x STG-2 2x STG-2-I ²⁾	2x STV-2 2x STV-2-I ²⁾
Materials in contact with media	Glass PTFE	PVDF
Flow rate v_{\max} ¹⁾	320 L/h	300 L/h
Inlet dew point $\tau_{e,\max}$ ¹⁾	70 °C	70 °C
Gas inlet temperature $\vartheta_{G,\max}$ ¹⁾	140 °C	140 °C
Gas pressure p_{\max}	3 bar	3 bar
Pressure drop Δp ($v=150$ L/h)	2.6 mbar	2.9 mbar
Max. Cooling capacity Q_{\max}	345 kJ/h	210 kJ/h
Dead volume V_{tot}	47 ml	41 ml
Gas connections (metric)	GL 14 (6 mm) ³⁾	DN 4/6
Gas connections (US)	GL 14 (1/4") ³⁾	1/4"-1/6"
Condensate out connection (metric)	GL 18 (10 mm) ³⁾	G1/4
Condensate out connection (US)	GL18 (10 mm) ³⁾	NPT 1/4"

¹⁾ Max. cooling capacity of the cooler must be considered.

²⁾ Models marked I have NPT threads or US tubes, respectively.

³⁾ Gasket inside diameter

10 Attached documents

- Declaration of Conformity KX440007
- O₂ declaration (heat exchanger)
- RMA – Decontamination Statement

EU-Konformitätserklärung
EU-declaration of conformity



Hiermit erklärt Bühler Technologies GmbH,
dass die nachfolgenden Produkte den
wesentlichen Anforderungen der Richtlinie

*Herewith declares Bühler Technologies GmbH
that the following products correspond to the
essential requirements of Directive*

2014/35/EU
(Niederspannungsrichtlinie / low voltage directive)

in ihrer aktuellen Fassung entsprechen.

in its actual version.

Folgende Richtlinie wurde berücksichtigt:

The following directive was regarded:

2014/30/EU (EMV/EMC)

Produkt / products: Peltier Messgaskühler / *Peltier sample gas cooler*
Typ / type: TC-MIDI, TC-MIDI+

Das Betriebsmittel dient der Aufbereitung des Messgases, um das Analysengerät vor Restfeuchtigkeit
im Messgas zu schützen.

*This equipment is used for conditioning the sample gas to protect the analysis instrument from residual
moisture in the sample gas.*

Das oben beschriebene Produkt der Erklärung erfüllt die einschlägigen
Harmonisierungsrechtsvorschriften der Union:

*The object of the declaration described above is in conformity with the relevant Union harmonisation
legislation:*

EN 61326-1:2013

EN 61010-1:2010/A1:2019/AC:2019-04

Die alleinige Verantwortung für die Ausstellung dieser Konformitätserklärung trägt der Hersteller.

This declaration of conformity is issued under the sole responsibility of the manufacturer.

Dokumentationsverantwortlicher für diese Konformitätserklärung ist Herr Stefan Eschweiler mit
Anschrift am Firmensitz.

*The person authorized to compile the technical file is Mr. Stefan Eschweiler located at the company's
address.*

Ratingen, den 17.02.2023

Stefan Eschweiler
Geschäftsführer – *Managing Director*

Frank Pospiech
Geschäftsführer – *Managing Director*

UK Declaration of Conformity



The manufacturer Bühler Technologies GmbH declares, under the sole responsibility, that the product complies with the requirements of the following UK legislation:

Electrical Equipment Safety Regulations 2016

The following legislation were regarded:

Electromagnetic Compatibility Regulations 2016

Product: Peltier sample gas cooler
Types: TC-MIDI
TC-MIDI+

The equipment is used for conditioning the sample gas to protect the analysis instrument from residual moisture in the sample gas.

The object of the declaration described above is in conformity with the relevant designated standards:

EN 61010-1:2010/A1:2019/AC:2019-04

EN 61326-1:2013

Ratingen in Germany, 17.02.2023

A handwritten signature in blue ink, appearing to be 'Stefan Eschweiler', written over a horizontal line.

Stefan Eschweiler
Managing Director

A handwritten signature in blue ink, appearing to be 'Frank Pospiech', written over a horizontal line.

Frank Pospiech
Managing Director

O₂-Erklärung *O₂ Declaration*

**Wärmetauscher für den Einsatz mit
hochreinem Sauerstoff optimiert**

*Heat Exchanger optimised for use with
high-purity oxygen*

Applikationen mit Sauerstoff: Partikel-, Öl- und Fettfreiheit

Mit dieser Erklärung bestätigen wir, dass alle medienberührenden Flächen der nachfolgenden Produkte in Anlehnung an die Vorgaben der EIGA Doc 33/18 und des VDA-Band 19 gereinigt und gefertigt sind.

Applications with oxygen: free of particles, oil and grease

With this declaration, we confirm that all surfaces of the following products that come into contact with media have been cleaned and manufactured in accordance with the specifications of EIGA Doc 33/18 and VDA Volume 19.

Produkt / Products	Wärmetauscher / Heat Exchanger	Art-Nr. / Item no.:
Typen / Types:	PTS-O2	4447999-O2
	PTS-I-O2	4448999I-O2
	TS-O2	4510023-O2
	TS-I-O2	4510025I-O2
	DTS-O2	4501026-O2
	DTS-I-O2	4501026I-O2

Ratingen, den 25.04.2024

Bühler Technologies GmbH



Condensate drains optimized for use with high-purity oxygen

Applications with oxygen: Free from particles, oil and grease



For use with high-purity oxygen, the product requires special cleaning to ensure that it is free from oil and grease, as oxygen is a strong oxidising agent. Under unfavourable conditions, oxygen can cause spontaneous combustion of organic substances such as particles, oils and fats, and generally promotes the combustion of substances. Oils and fats can even react explosively on contact with oxygen. We use special cleaning and production processes to ensure the safe use of our products with high-purity oxygen and to avoid the above-mentioned undesirable reactions.

With this declaration, we confirm that all surfaces of the following products that come into contact with media have been cleaned and manufactured in accordance with the requirements of EIGA Doc 33/18 and VDA Volume 19.

Product:	Condensate drain
Type:	11 LD V 38 -O2
Item no.:	4410001-O2

The material used for the “O2” condensate drain is high-quality stainless steel, which has been tested by Bühler Technologies for its suitability for oxygen applications.

All components in contact with the medium undergo a special cleaning process to reliably remove impurities (such as oil, grease and particles). This process is documented by a comprehensive delivery specification to the service provider and compliance with the limits is verified with regular analyses by an independent, accredited laboratory.

The contamination limits of the surfaces in contact with media are defined as follows (as in EIGA Doc 33/18 Cleaning of Equipment for oxygen service):

	Contamination limits
Non-volatile organic or inorganic impurities:	≤ 220 mg/m ² for non-volatile impurities
Particles:	≤ 22 particles/m ² between 500 µm and 1000 µm

The condensate drains are cleaned and packaged by an external service provider to prevent them from becoming soiled again until they are installed at the customer's premises.

Compliance with the contamination limits is documented by the external service provider by means of factory test certificates (free of oil and grease) and a test report (free of dust and dirt). After cleaning, the condensate drains are packed in airtight and dustproof packaging and clearly labeled “Cleaned for oxygen service. Do not open until ready for use”.

All described cleaning properties are lost if the product comes into contact with oily or greasy media or is otherwise contaminated from the outside.



RMA-Formular und Erklärung über Dekontaminierung

RMA-Form and explanation for decontamination



RMA-Nr./ RMA-No.

Die RMA-Nr. bekommen Sie von Ihrem Ansprechpartner im Vertrieb oder Service. Bei Rücksendung eines Altgeräts zur Entsorgung tragen Sie bitte in das Feld der RMA-Nr. "WEEE" ein./ You may obtain the RMA number from your sales or service representative. When returning an old appliance for disposal, please enter "WEEE" in the RMA number box.

Zu diesem Rücksendeschein gehört eine Dekontaminierungserklärung. Die gesetzlichen Vorschriften schreiben vor, dass Sie uns diese Dekontaminierungserklärung ausgefüllt und unterschrieben zurücksenden müssen. Bitte füllen Sie auch diese im Sinne der Gesundheit unserer Mitarbeiter vollständig aus./ This return form includes a decontamination statement. The law requires you to submit this completed and signed decontamination statement to us. Please complete the entire form, also in the interest of our employee health.

Firma/ Company

Firma/ Company

Straße/ Street

PLZ, Ort/ Zip, City

Land/ Country

Gerät/ Device

Anzahl/ Quantity

Auftragsnr./ Order No.

Ansprechpartner/ Person in charge

Name/ Name

Abt./ Dept.

Tel./ Phone

E-Mail

Serien-Nr./ Serial No.

Artikel-Nr./ Item No.

Grund der Rücksendung/ Reason for return

- Kalibrierung/ Calibration Modifikation/ Modification
 Reklamation/ Claim Reparatur/ Repair
 Elektroaltgerät/ Waste Electrical & Electronic Equipment (WEEE)
 andere/ other

bitte spezifizieren/ please specify

Ist das Gerät möglicherweise kontaminiert?/ Could the equipment be contaminated?

- Nein, da das Gerät nicht mit gesundheitsgefährdenden Stoffen betrieben wurde./ No, because the device was not operated with hazardous substances.
 Nein, da das Gerät ordnungsgemäß gereinigt und dekontaminiert wurde./ No, because the device has been properly cleaned and decontaminated.
 Ja, kontaminiert mit:/ Yes, contaminated with:



explosiv/
explosive



entzündlich/
flammable



brandfördernd/
oxidizing



komprimierte
Gase/
compressed
gases



ätzend/
caustic



giftig,
Lebensgefahr/
poisonous, risk
of death



gesundheitsge-
fährdend/
harmful to
health



gesund-
heitsgefährlich/
health hazard



umweltge-
fährdend/
environmental
hazard

Bitte Sicherheitsdatenblatt beilegen!/ Please enclose safety data sheet!

Das Gerät wurde gespült mit:/ The equipment was purged with:

Diese Erklärung wurde korrekt und vollständig ausgefüllt und von einer dazu befugten Person unterschrieben. Der Versand der (dekontaminierten) Geräte und Komponenten erfolgt gemäß den gesetzlichen Bestimmungen.

This declaration has been filled out correctly and completely, and signed by an authorized person. The dispatch of the (decontaminated) devices and components takes place according to the legal regulations.

Falls die Ware nicht gereinigt, also kontaminiert bei uns eintrifft, muss die Firma Bühler sich vorbehalten, diese durch einen externen Dienstleister reinigen zu lassen und Ihnen dies in Rechnung zu stellen.

Should the goods not arrive clean, but contaminated, Bühler reserves the right, to commission an external service provider to clean the goods and invoice it to your account.

Firmenstempel/ Company Sign

Datum/ Date

rechtsverbindliche Unterschrift/ Legally binding signature



Vermeiden von Veränderung und Beschädigung der einzusendenden Baugruppe

Die Analyse defekter Baugruppen ist ein wesentlicher Bestandteil der Qualitätssicherung der Firma Bühler Technologies GmbH. Um eine aussagekräftige Analyse zu gewährleisten muss die Ware möglichst unverändert untersucht werden. Es dürfen keine Veränderungen oder weitere Beschädigungen auftreten, die Ursachen verdecken oder eine Analyse unmöglich machen.

Umgang mit elektrostatisch sensiblen Baugruppen

Bei elektronischen Baugruppen kann es sich um elektrostatisch sensible Baugruppen handeln. Es ist darauf zu achten, diese Baugruppen ESD-gerecht zu behandeln. Nach Möglichkeit sollten die Baugruppen an einem ESD-gerechten Arbeitsplatz getauscht werden. Ist dies nicht möglich sollten ESD-gerechte Maßnahmen beim Austausch getroffen werden. Der Transport darf nur in ESD-gerechten Behältnissen durchgeführt werden. Die Verpackung der Baugruppen muss ESD-konform sein. Verwenden Sie nach Möglichkeit die Verpackung des Ersatzteils oder wählen Sie selber eine ESD-gerechte Verpackung.

Einbau von Ersatzteilen

Beachten Sie beim Einbau des Ersatzteils die gleichen Vorgaben wie oben beschrieben. Achten Sie auf die ordnungsgemäße Montage des Bauteils und aller Komponenten. Versetzen Sie vor der Inbetriebnahme die Verkabelung wieder in den ursprünglichen Zustand. Fragen Sie im Zweifel beim Hersteller nach weiteren Informationen.

Einsenden von Elektroaltgeräten zur Entsorgung

Wollen Sie ein von Bühler Technologies GmbH stammendes Elektroprodukt zur fachgerechten Entsorgung einsenden, dann tragen Sie bitte in das Feld der RMA-Nr. „WEEE“ ein. Legen Sie dem Altgerät die vollständig ausgefüllte Dekontaminierungserklärung für den Transport von außen sichtbar bei. Weitere Informationen zur Entsorgung von Elektroaltgeräten finden Sie auf der Webseite unseres Unternehmens.

Avoiding alterations and damage to the components to be returned

Analysing defective assemblies is an essential part of quality assurance at Bühler Technologies GmbH. To ensure conclusive analysis the goods must be inspected unaltered, if possible. Modifications or other damages which may hide the cause or render it impossible to analyse are prohibited.

Handling electrostatically conductive components

Electronic assemblies may be sensitive to static electricity. Be sure to handle these assemblies in an ESD-safe manner. Where possible, the assemblies should be replaced in an ESD-safe location. If unable to do so, take ESD-safe precautions when replacing these. Must be transported in ESD-safe containers. The packaging of the assemblies must be ESD-safe. If possible, use the packaging of the spare part or use ESD-safe packaging.

Fitting of spare parts

Observe the above specifications when installing the spare part. Ensure the part and all components are properly installed. Return the cables to the original state before putting into service. When in doubt, contact the manufacturer for additional information.

Returning old electrical appliances for disposal

If you wish to return an electrical product from Bühler Technologies GmbH for proper disposal, please enter "WEEE" in the RMA number box. Please attach the fully completed decontamination declaration form for transport to the old appliance so that it is visible from the outside. You can find more information on the disposal of old electrical appliances on our company's website.

