**User's
Manual**



Model 436101/436102/436103/436104/436106

μR10000 Recorder

Introduction

Thank you for purchasing the YOKOGAWA μ R10000 Recorder.

This manual describes the functions (excluding the communication functions), installation and wiring procedures, operating procedures, and lists the handling precautions of the μ R10000 Recorder. To ensure correct use, please read this manual thoroughly before beginning operation.

The following manuals are provided for the recorder.

- **Paper Manual**

Manual Title	Manual No.	Description
μ R10000 Recorder Operation Guide	IM 04P01B01-02E	Explains concisely the operations of the μ R10000 Recorder.

- **Electronic Manuals**

Manual Title	Manual No.	Description
μ R10000 Recorder User's Manual	IM 04P01B01-01E	This manual.
μ R10000/ μ R20000 Communication Interface User's Manual	IM 04P01B01-17E	Explains the communication functions of the μ R10000 Recorder using Ethernet interface and the RS-422A/485 communication interface.
μ R10000/ μ R20000 SD Memory Card (/EM1 option) User's Manual	IM 04P01B01-03E	Explains how to use SD memory cards.

Notes

- The contents of this manual are subject to change without prior notice as a result of continuing improvements to the instrument's performance and functions.
- Every effort has been made in the preparation of this manual to ensure the accuracy of its contents. However, should you have any questions or find any errors, please contact your nearest YOKOGAWA dealer as listed on the back cover of this manual.
- Copying or reproducing all or any part of the contents of this manual without the permission of Yokogawa Electric Corporation is strictly prohibited.
- The TCP/IP software of this product and the document concerning the TCP/IP software have been developed/created by YOKOGAWA based on the BSD Networking Software, Release 1 that has been licensed from the University of California.

QR Code

The product has a QR Code pasted for efficient plant maintenance work and asset information management.

It enables confirming the specifications of purchased products and user's manuals. For more details, please refer to the following URL.

<https://www.yokogawa.com/qr-code>

QR Code is a registered trademark of DENSO WAVE INCORPORATED.

Trademarks

- All the brands or names of Yokogawa Electric's products used in this manual are either trademarks or registered trademarks of Yokogawa Electric Corporation.
- Microsoft and Windows are either registered trademarks or trademarks of Microsoft Corporation in the United States and/or other countries.
- Adobe, Acrobat, and PostScript are trademarks of Adobe Systems incorporated.
- The SD logo is a registered trademark of the SD association.
- For purposes of this manual, the TM and © symbols do not accompany their respective trademark names or registered trademark names.
- Company and product names that appear in this manual are trademarks or registered trademarks of their respective holders.

Revisions

1st Edition	December 2004	2nd Edition	March 2005
3rd Edition	August 2005	4th Edition	September 2006
5th Edition	April 2011	6th Edition	March 2015
7th Edition	July 2017	8th Edition	September 2018
9th Edition	February 2020	10th Edition	February 2021
11th Edition	November 2022	12th Edition	September 2023

Recorder's Version and Functions Described in This Manual

The contents of this manual corresponds to the recorder with version 1.5x.

μR10000 Versions and Functions

Version	Suffix Code	Added or Modified Functions	Reference
1.02 or earlier	–	–	–
1.1x	–	(Added) The printout/display format of the date can be changed.	Section 7.19
	–	(Added) Key operation to move the printer carriage near the center position so that the ribbon cassette can be replaced with the recorder turned ON (dot model)	Section 3.4
	–	(Changed) Selectable range of alarm values during linear scaling (including 1-5V and SQRT) to –5% to 105% of the scale span.	Section 5.2
	–	(Changed) The procedure to set the start/end date and time of Daylight Saving Time (DST) has been changed.	Section 6.16
	/C3	(Added) Modbus/RTU slave protocol, two-wire system.	Communication manual
	/C7	(Changed) Users with the same user name cannot be registered.	Communication manual
1.2x	-2	(Added) Language support (German and French).	Section 1.9
	/CC1	(Added) Calibration Correction.	Section 1.2
	/H5x	(Added) Portable type.	Sections 2.5 and 12.7
	/P1	(Added) 24 VDC/AC power supply operation.	Section 2.5
1.3x	–	(Added) Customized menu.	Section 1.9
	–	(Added) Modbus register (40301 to 40348).	Communication manual
	/BT1	(Added) Header printout.	Section 1.4
1.4x	/EM1	(Added) SD memory card.	IM 04P01B01-03E
1.5x	–	(Changed) Style (H): 4* * Style (H) 4 supports firmware version 1.5x or later.	–

- Checking the Version Number

You can check the version number on the System display.

The System display cannot be shown at the factory default condition.

First, register the System display to the display screen.

- Procedure of registering the System display to the display screen: See section 8.2.
- Procedure of displaying the System display: The screen switches each time the **[DISP]** key is pressed. Press the **[DISP]** key repeatedly until System display is shown. The displayed contents on the System display switches every 3 seconds. Check the number shown by the "Version:" item.

Software (Sold Separately)

The table below shows the relationship between the RXA10 Configuration Software revisions and the μR10000 recorder versions.

		Recorder version					
		1.02 or earlier	1.1x	1.2x	1.3x	1.4x	1.5x
RXA10 Configuration Software revision	R1.01	Yes	Limited				
	R2.01	Yes	Yes	Yes	Limited		
	R3.01	Yes	Yes	Yes	Yes	Limited	
	R3.05	Yes	Yes	Yes	Yes	Yes	Limited
	R3.06	Yes	Yes	Yes	Yes	Yes	Yes

Yes: Compatible

Limited: The new functions of the recorder cannot be configured from the RXA10.

Note

Set the recorder version in the RXA10 Configuration Software to display the setup items that match the recorder's functions.

Safety Precautions

The general safety precautions described here must be observed during all phases of operation.

Safety Standards and EMC Standards

This recorder conforms to IEC safety class I (provided with terminal for protective grounding), Overvoltage Category II or I^{*1}, Pollution Degree 2, Measurement Category II (CAT II)^{*2}, and EN 61326-1 (EMC standard) class A (use in a commercial, industrial, or business environment). The influence rate (judgment condition A) in the immunity test environment is within $\pm 10\%$ of the range. This recorder is designed for indoor use.

*1 II : Applied to standard power supply (100-240 VAC), I: Applied to /P1 option (24 VDC/AC)

*2 Measurement Category II (CAT II) applies to measuring circuits connected to low voltage installation, and electrical instruments supplied with power from fixed equipment such as electric switchboards.

About This Manual

- This manual should be read by the end user.
- Read this manual thoroughly and have a clear understanding of the product before operation.
- This manual explains the functions of the product. YOKOGAWA does not guarantee that the product will suit a particular purpose of the user.
- Under absolutely no circumstances may the contents of this manual be transcribed or copied, in part or in whole, without permission.
- The contents of this manual are subject to change without prior notice.
- Every effort has been made in the preparation of this manual to ensure the accuracy of its contents. However, should you have any questions or find any errors or omissions, please contact your nearest YOKOGAWA dealer.

Precautions Related to the Protection, Safety, and Alteration of the Product

- The following safety symbols are used on the product and in this manual.



“Handle with care.” To avoid injury and damage to the instrument, the operator must refer to the explanation in the manual.



Protective ground terminal



AC



DC



“High temperature.” To avoid injury caused by hot surface, do not touch locations where this symbol appears.

- For the protection and safe use of the product and the system controlled by it, be sure to follow the instructions and precautions on safety that are stated in this manual whenever you handle the product. Take special note that if you handle the product in a manner that violate these instructions, the protection functionality of the product may be damaged or impaired. In such cases, YOKOGAWA does not guarantee the quality, performance, function, and safety of the product.
- When installing protection and/or safety circuits such as lightning protection devices and equipment for the product and control system or designing or installing separate protection and/or safety circuits for fool-proof design and fail-safe design of the processes and lines that use the product and the control system, the user should implement these using additional devices and equipment.
- If you are replacing parts or consumable items of the product, make sure to use parts specified by YOKOGAWA.
- This product is not designed or manufactured to be used in critical applications that directly affect or threaten human lives. Such applications include nuclear power equipment, devices using radioactivity, railway facilities, aviation equipment, air navigation facilities, aviation facilities, and medical equipment. If so used, it is the user's responsibility to include in the system additional equipment and devices that ensure personnel safety.
- Do not modify this product.

**WARNING**

- **Use the Correct Power Supply**
Ensure that the source voltage matches the voltage of the power supply before turning ON the power.
- **Connect the Protective Grounding Terminal**
Make sure to connect the protective grounding to prevent electric shock before turning ON the power.
- **Necessity of Protective Grounding**
Never cut off the internal or external protective earth wire or disconnect the wiring of the protective earth terminal. Doing so invalidates the protective functions of the instrument and poses a potential shock hazard.
- **Defect of Protective Grounding**
Do not operate the instrument if the protective earth or fuse might be defective. Make sure to check them before operation.
- **Do Not Operate in an Explosive Atmosphere**
Do not operate the instrument in the presence of flammable liquids or vapors. Operation in such environments constitutes a safety hazard.
- **Do Not Remove Covers**
The cover should be removed by YOKOGAWA's qualified personnel only. Opening the cover is dangerous, because some areas inside the instrument have high voltages.
- **External Connection**
Connect the protective grounding before connecting to the item under measurement or to an external control unit.
- **Damage to the Protective Structure**
Operating the recorder in a manner not described in this manual may damage its protective structure.

Portable Type (/H5x Option)

- **Use the Correct Power Supply**
Ensure that the power supply is within the maximum rated voltage range of the provided power cord before connecting the power cord.
- **Use the Correct Power Cord and Plug**
To prevent electric shock or fire, be sure to use the power cord supplied by YOKOGAWA. The main power plug must be plugged into an outlet with a protective earth terminal. Do not disable this protection by using an extension cord without protective earth grounding. The power cord is designed for use with this instrument. Do not use the power cord with other instruments.
- **Connect the Protective Grounding Terminal**
The power cord for the μ R10000 is a three-prong type power cord. Connect the power cord to a properly grounded three-prong outlet.

**CAUTION**

This instrument is a Class A product. Operation of this instrument in a residential area may cause radio interference, in which case the user is required to take appropriate measures to correct the interference.

Exemption from Responsibility

- YOKOGAWA makes no warranties regarding the product except those stated in the WARRANTY that is provided separately.
- YOKOGAWA assumes no liability to any party for any loss or damage, direct or indirect, caused by the user or any unpredictable defect of the product.

Handling Precautions of the Software

- YOKOGAWA makes no warranties regarding the software accompanying this product except those stated in the WARRANTY that is provided separately.
- Use the software on a single PC.
- You must purchase another copy of the software, if you are to use the software on another PC.
- Copying the software for any purposes other than backup is strictly prohibited.
- Please store the original media containing the software in a safe place.
- Reverse engineering, such as decompiling of the software, is strictly prohibited.
- No portion of the software supplied by YOKOGAWA may be transferred, exchanged, sublet, or leased for use by any third party without prior permission by YOKOGAWA.

Checking the Contents of the Package

Unpack the box and check the contents before operating the recorder. If some of the contents are not correct or missing or if there is physical damage, contact the dealer from which you purchased them.

Checking the Model

A name plate is affixed to the recorder. Check that the model name and suffix code given on the name plate on the rear panel match those on your order.

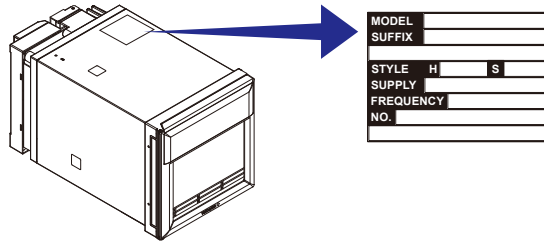

MODEL and SUFFIX Code

Model	Suffix Code	Optional Code	Description
436101			μR10000 1 pen recorder
436102			μR10000 2 pen recorder
436103			μR10000 3 pen recorder
436104			μR10000 4 pen recorder
436106			μR10000 6 dot recorder
	-2		English/German/French & deg F/DST
		/A1	Alarm output relay 2 points ¹
		/A2	Alarm output relay 4 points ¹
		/A3	Alarm output relay 6 points ¹
		/C3	RS-422A/485 interface ²
		/C7	Ethernet (10BASE-T) interface ²
		/H2	Clamped input terminal ³
		/H3	Non-glare door glass
		/H5D	Portable type Power cord UL, CSA st'd ⁶
		/H5F	Portable type Power cord VDE st'd ⁶
		/H5R	Portable type Power cord AS st'd ⁶
		/H5J	Portable type Power cord BS st'd ⁶
		/H5H	Portable type Power cord GB st'd ⁶
		/M1	Mathematical function
		/N1	Cu10, Cu25 RTD input
		/N2	3 legs isolated RTD ^{3,4}
		/N3	Expansion inputs ⁵
		/P1	24 VDC/AC power supply ⁶
		/R1	Remote control 5 points
		/CC1	Calibration Correction
		/BT1	Header printout
		/EM1	SD memory card ⁷
		/S#	Customized Product; for more detail, please see IM 4361-S# or IM 4371-S# ⁸

¹ /A1, /A2, and /A3 cannot be specified simultaneously.

² /C3 and /C7 cannot be specified simultaneously.

³ /H2 and /N2 cannot be specified simultaneously.

⁴ Valid only on the model 436106.

⁵ 14 types of input including Pt50 RTD, PR40-20, and Platinel TC.

⁶ /H5x and /P1 cannot be specified simultaneously.

⁷ /C3 and /EM1 cannot be specified simultaneously.

⁸ For customized product, the product is identified by the option code of /S# (where '#' is a number). Contact your supplier in case your instrument has option /S#, and you are not in the possession of IM 4361-S# or IM 4371-S#.

Standard Accessories

The standard accessories below are supplied with the recorder. Check that all contents are present and undamaged.

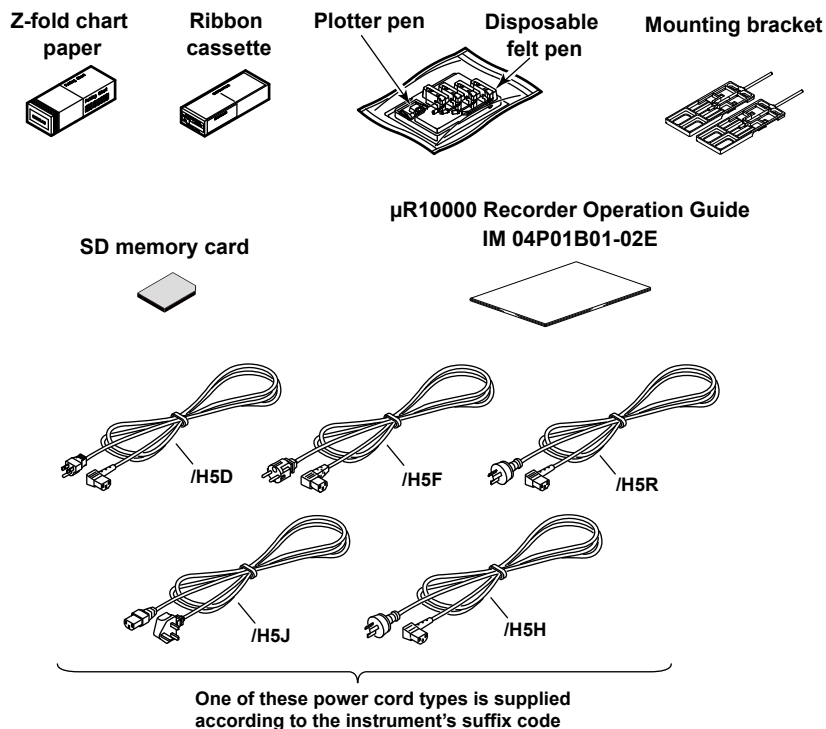

Part Number	Note
A1006WD	Provided when optional code /H5D is specified. Maximum rated power voltage: 125 V
A1009WD	Provided when optional code /H5F is specified. Maximum rated power voltage: 250 V
A1024WD	Provided when optional code /H5R is specified. Maximum rated power voltage: 250 V
A1023WD	Provided when optional code /H5J is specified. Maximum rated power voltage: 250 V
A1064WD	Provided when optional code /H5H is specified. Maximum rated power voltage: 250 V

Item	1-Pen	2-Pen	3-Pen	4-Pen	Dot Printing	
Z-fold chart paper	1	1	1	1	1	
Ribbon cassette	-	-	-	-	1	
Disposable felt pen	Red	1	1	1	-	
	Green	-	1	1	1	
	Blue	-	-	1	1	-
	Violet	-	-	-	1	-
Plotter pen	1	1	1	1	-	
Mounting bracket (included with models without /H5x)	2	2	2	2	2	
Power cord (included with /H5x)	1	1	1	1	1	
SD memory card 1 GB (included with /EM1)	1	1	1	1	1	
μR10000 Recorder Operation Guide IM 04P01B01-02E	1	1	1	1	1	

Optional Accessories (Sold Separately)

The optional accessories below are available for purchase separately. If you make an order, make sure that all contents are present and undamaged.

For information about ordering accessories, contact the dealer from which you purchased the recorder.

Item	Model (Part Number)	Quantity	Note	
Z-fold chart paper	B9565AW	1	10 pcs.	
Ribbon cassette	B9901AX	1		
Disposable felt pen	Red	B9902AM	1	3 pcs.
	Green	B9902AN	1	3 pcs.
	Blue	B9902AP	1	3 pcs.
	Violet	B9902AQ	1	3 pcs.
Plotter pen	Purple	B9902AR	1	3 pcs.
Mounting bracket	B9900BX	2		
Shunt resistor for the screw terminal (standard)	415920	1	250 Ω ±0.1%	
	415921	1	100 Ω ±0.1%	
	415922	1	10 Ω ±0.1%	
Shunt resistor for the clamped input terminal (/H2)	438920	1	250 Ω ±0.1%	
	438921	1	100 Ω ±0.1%	
	438922	1	10 Ω ±0.1%	
SD memory card	773001	1	1 GB	

Software (Sold Separately)

Item	Model	Note
Configuration software	RXA10-01	
	RXA10-02	With interface unit*

* You can use the Configuration Software if you install the interface unit to a recorder does not include the communication function. An interface unit cannot be installed in a recorder with an SD memory card function (/EM1 option).

Removing the Packing Materials

Open the door, put your finger on the tab at the lower left of the display, and open the display.

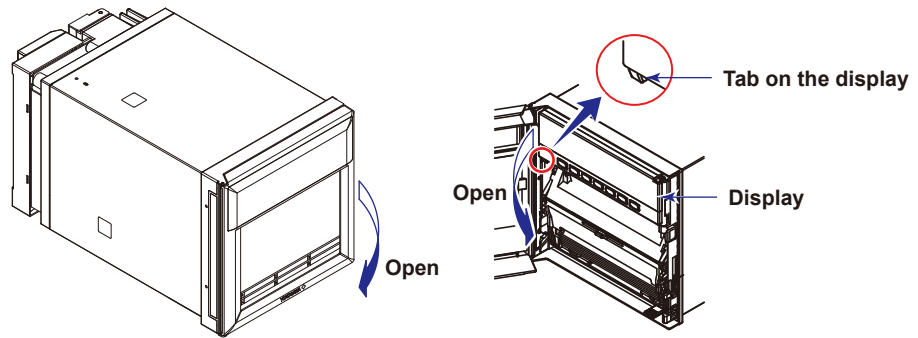

Remove all packing materials.

- **Pen Model**

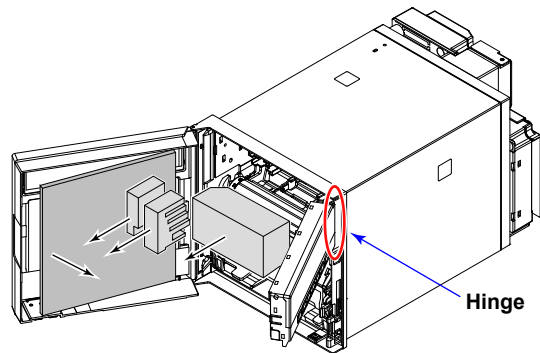

- **Dot Model**

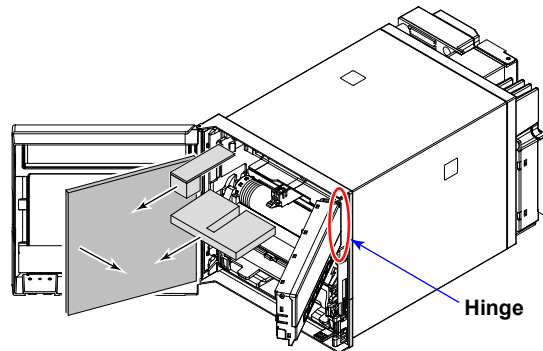

CAUTION

To protect the hinges, do not apply vertical force on the display.

How to Use This Manual

This user's manual consists of the following sections.

For information about the communication functions, see the *μR10000/μR20000 Communication Interface User's Manual*, IM 04P01B01-17E.

Chapter	Title and Description
1	Functional Explanation and Setup Guide Describes the functions of the μR10000 Recorder and provides a function setup guide. Refer to this chapter when you are unsure of the details of the function that you are operating.
2	Before Using the Recorder Describes the installation and wiring procedures.
3	Names of Parts and Run Operations Describes the names of each part of the recorder and the daily operations.
4	Common Operations for Setting Functions and Setup Menu Explains the recorder operation modes and the basic setup operations using keys. It also provides menu configuration diagrams and lists of setup items.
5	Frequently Used Setup Operations (Setting Mode) Describes how to change the input range, alarms, chart speed, etc.
6	Setup Operations for Convenient Functions (Setting Mode) Describes the setup operations for convenient functions such as how to assign tags to channels and how to set message strings that are to be printed.
7	Setup Operations for Changing/Adding Functions (Basic Setting Mode) Describes the setup operations for changing or adding functions such as setting the recorder to detect sensor burnouts and changing the contents that are printed on the chart paper.
8	Setup Operations for Changing the Displayed Contents Describes how to select the display type suitable for the application.
9	Operations Related to the Computation Function (/M1 Option) Describes all operations related to the computation function.
10	Troubleshooting Describes error message and troubleshooting measures of the μR10000 Recorder.
11	Maintenance Describes periodic inspection, calibration, pen adjustment/printer carriage adjustment, and recommended replacement period for worn parts.
12	Specifications Gives the specifications of the μR10000 Recorder.
Appendix	Describes the printout contents.
Index	

Note

- This user's manual covers information regarding the recorders with English as the display/printout language (suffix code "2").
 - For the procedure of setting the display/printout language, see section 7.14, "Changing the Display/Printout Language."
-

Conventions Used in This Manual

Unit

K Denotes 1024. Example: 768 KB (file size)

k Denotes 1000.

Safety Markings

The following markings are used in this manual.



Improper handling or use can lead to injury to the user or damage to the instrument. This symbol appears on the instrument to indicate that the user must refer to the user's manual for special instructions. The same symbol appears in the corresponding place in the user's manual to identify those instructions. In the manual, the symbol is used in conjunction with the word "WARNING" or "CAUTION."

WARNING

Calls attention to actions or conditions that could cause serious or fatal injury to the user, and precautions that can be taken to prevent such occurrences.

CAUTION

Calls attentions to actions or conditions that could cause light injury to the user or damage to the instrument or user's data, and precautions that can be taken to prevent such occurrences.

Note

Calls attention to information that is important for proper operation of the instrument.

Subheadings

On pages that describe the operating procedures in Chapter 3 through 9, the following symbols are used to distinguish the procedures from their explanations.

Bold characters denote keys or character strings that are displayed on the screen.

Example: **Range, Unit**





Procedure

Follow the numbered steps. All procedures are written with inexperienced users in mind; depending on the operation, not all steps need to be taken.

Explanation

This subsection describes the setting parameters and the limitations on the procedures. It does not give a detailed explanation of the function. For details on the function, see chapter 1.

Contents

Introduction	i
Recorder's Version and Functions Described in This Manual	iii
 Safety Precautions	iv
Checking the Contents of the Package.....	vii
How to Use This Manual.....	xi
Chapter 1 Functional Explanation and Setup Guide	
1.1 Overview of the Recorder	1-1
1.2 Measuring Input Section	1-2
1.3 Alarms.....	1-7
1.4 Recording	1-13
1.5 Display	1-24
1.6 Computation Function (/M1 Option).....	1-26
1.7 FAIL/Chart End Detection and Output Function (/F1 Option)	1-29
1.8 Remote Control Function (/R1 Option)	1-30
1.9 Other Functions	1-32
1.10 Function Setup Guide	1-34
Chapter 2 Before Using the Recorder	
2.1 Handling Precautions.....	2-1
2.2 Installation.....	2-2
 2.3 Input Signal Wiring.....	2-4
 2.4 Optional Terminal Wiring.....	2-8
 2.5 Power Supply Wiring	2-11
 2.6 Turning ON/OFF the Power Switch	2-13
Chapter 3 Names of Parts and Run Operations	
3.1 Names of Parts	3-1
3.2 Installing or Replacing the Chart Paper	3-4
3.3 Installing/Replacing Felt Pens or Plotter Pen (Pen Model).....	3-7
3.4 Installing/Replacing the Ribbon Cassette (Dot Model)	3-9
3.5 Starting/Stopping the Recording.....	3-11
3.6 Switching the Display Screen	3-12
3.7 Printing Measured Values (Manual Printout)	3-13
3.8 Printing the Recorder Settings.....	3-14
3.9 Clearing the Alarm Printout Buffer	3-15
3.10 Printing Messages	3-16
3.11 Resetting the Report Data of the Periodic Printout.....	3-17
3.12 Releasing the Alarm Output (Alarm ACK Operation).....	3-18
3.13 Activating/Releasing the Key Lock	3-19
Chapter 4 Common Operations for Setting Functions and Setup Menu	
4.1 Run Modes	4-1
4.2 Key Operations	4-2
4.3 Menu Structure, Settings, and List of Default Values.....	4-5
Chapter 5 Frequently Used Setup Operations (Setting Mode)	
5.1 Setting the Input Range	5-1
5.2 Setting the Alarm	5-9

5.3	Setting the Unit on Scaled Channels	5-12
5.4	Changing the Chart Speed	5-13
5.5	Setting the Date/Time	5-14

Chapter 6 Setup Operations for Convenient Functions (Setting Mode)

6.1	Setting the Trend Recording Interval (Dot Model)	6-1
6.2	Setting the Filter (Pen Model)	6-3
6.3	Setting the Moving Average (Dot Model)	6-4
6.4	Setting Recording Zones for Each Channel (Zone Recording)	6-5
6.5	Setting the Partial Expanded Recording	6-6
6.6	Turning Trend Recording (Dot Model) and Periodic Printout ON/OFF for Each Channel...	6-7
6.7	Setting Tags on Channels	6-8
6.8	Setting the Message String	6-9
6.9	Setting the Secondary Chart Speed (Remote Control Function, /R1)	6-10
6.10	Setting the Alarm Delay Duration	6-11
6.11	Setting the Brightness of the Display and Internal Light	6-12
6.12	Applying a Bias on the Measuring Input Signal	6-13
6.13	Performing Calibration Correction (/CC1 Option)	6-14
6.14	Setting Up Start Printout and End printout (/BT1 Option)	6-16
6.15	Setting the Message Format (/BT1 Option)	6-20
6.16	Setting the Date/Time When Switching between Standard Time and DST	6-22

Chapter 7 Setup Operations for Changing/Adding Functions (Basic Setting Mode)

7.1	Changing the Auxiliary Alarm Function	7-1
7.2	Changing the Integration Time of the A/D Converter	7-4
7.3	Setting the Burnout Detection Function of Thermocouples	7-5
7.4	Setting the RJC Function on Channels Set to TC Input	7-6
7.5	Changing the Channel Recording Color (Dot Model)	7-8
7.6	Recording by Compensating for the Pen Offset along the Time Axis (Pen Model)	7-9
7.7	Turning Printouts ON/OFF (Selecting the Channel/Tag Printout and Turning ON/OFF the Channel No., Alarm, Recording Start, New Chart Speed, Scale, and Pen Color Printouts)	7-10
7.8	Setting the Periodic Printout Interval and the Type of Data to Be Printed	7-12
7.9	Setting the Bar Graph Display Mode	7-15
7.10	Setting the Key Lock Function	7-16
7.11	Enabling the Moving Average Function (Dot Model)	7-19
7.12	Enabling the Filter Function (Pen Model)	7-20
7.13	Enabling the Partial Expanded Recording Function	7-21
7.14	Changing the Display/Printout Language	7-22
7.15	Enabling the Bias, Low-Cut, Alarm Delay, Calibration Correction (/CC1 Option) Functions	7-23
7.16	Changing the Time Printout Format	7-25
7.17	Initializing the Settings	7-27
7.18	Assigning Functions to the Remote Control Input Terminals (/R1 Option)	7-28
7.19	Changing the Printout/Display Format of the Date	7-30
7.20	Selecting to Show/Hide the FUNC Key Menus	7-31
7.21	Selecting to Show/Hide Setting Mode Menus	7-33
7.22	Enabling/Disabling the Customized Menu	7-35
7.23	Setting the Calibration Correction Function (/CC1 Option)	7-38
7.24	Enabling Start Printout, End printout, and Message Format (/BT1 Option)	7-40
7.25	Changing the Temperature Unit	7-42

Chapter 8	Setup Operations for Changing the Displayed Contents	
8.1	Key Operations for Changing the Displayed Information.....	8-1
8.2	Changing the Displayed Information.....	8-3
Chapter 9	Operations Related to the Computation Function (/M1 Option)	
9.1	Starting/Stopping/Resetting the Computation.....	9-1
9.2	Setting the Computing Equation.....	9-2
9.3	Setting the Unit.....	9-9
9.4	Setting the Constants Used in Equations.....	9-10
9.5	Setting the Alarm.....	9-11
9.6	Specifying the Timer Used in Statistical Calculations (TLOG).....	9-13
9.7	Setting Recording Zones for Each Channel (Zone Recording).....	9-15
9.8	Setting the Partial Expanded Recording.....	9-16
9.9	Turning Trend Recording (Dot Model) and Periodic Printout (Including the Printout Using the TLOG Timer) ON/OFF for Each Channel.....	9-17
9.10	Setting Tags on Channels.....	9-18
9.11	Setting the Alarm Delay Duration.....	9-19
9.12	Setting the Timer Used in TLOG Computation and Periodic Printout.....	9-20
9.13	Changing the Channel Recording Color (Dot Model).....	9-23
9.14	Changing the Channel Assignments of Recording Pens (Pen Model).....	9-24
9.15	Changing the Type of Report Data Printed in Periodic Printout.....	9-25
9.16	Setting the Bar Graph Display Mode.....	9-27
9.17	Setting the Procedure Taken When the Computed Result Is in Error.....	9-28
Chapter 10	Troubleshooting	
10.1	A List of Error Messages.....	10-1
10.2	Troubleshooting Flow Charts.....	10-4
Chapter 11	Maintenance	
11.1	Periodic Inspection.....	11-1
11.2	Cleaning the Recorder.....	11-2
11.3	Replacing the Internal Light LED.....	11-3
11.4	Calibrating the Recorder.....	11-4
11.5	Adjusting the Pen Position (Pen Model).....	11-6
11.6	Adjusting the Dot Printing Position (Dot Model).....	11-8
11.7	Recommended Replacement Periods for Worn Parts.....	11-10
Chapter 12	Specifications	
12.1	Input Specifications.....	12-1
12.2	Alarm Function Specifications.....	12-3
12.3	Recording Function Specifications.....	12-4
12.4	Display Function Specifications.....	12-7
12.5	Specifications of Optional Functions.....	12-13
12.6	General Specifications.....	12-18
12.7	Dimensional Drawings.....	12-23
Appendix		
Appendix 1	Periodic Printout and Printout Using the TLOG Timer (/M1 Option).....	App-1
Appendix 2	Periodic Printout Interval.....	App-6

Index



Blank

1.1 Overview of the Recorder

The μ R10000 Recorder (hereafter referred to as the recorder) can be used to assign DC voltage, 1-5V, thermocouple, RTD, and contact or voltage ON/OFF signal to channels for measurement. The measured results are recorded with pens or dots on a chart paper that is fed at a constant speed. The pen model can record up to 4 channels; the dot model can record up to 6 channels.

μ R10000 Recorder

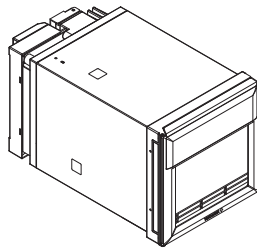

Recording example (dot model)



Alarms

For each channel, various alarms such as high limit alarm and low limit alarm can be assigned to monitor the measured values. Alarm output relays can be used to output contact signals when alarms occur (/A1, /A2, and /A3 options).

Recording

The measured results are recorded with pens or dots on a chart paper (trend recording). The chart speed can be selected from 5 to 12000 mm/h on the pen model and 1 to 1500 mm/h on the dot model.

In addition to trend recording, various types of information can be printed or recorded on the chart paper such as numeric measured values, alarm occurrence/release, and predefined messages. Also, the recorder settings can be printed.

Internal Light

A light is provided for easier viewing of the recording area of the chart paper.

Display

Measured values can be displayed numerically or using bar graphs on the large display. Also, alarm status and chart speed can be displayed.

Communication Function

Using the Ethernet communication interface (/C7 option) or the RS-422A/485 communication interface (/C3 option), the measured values on the recorder can be output to a PC or a PC can be used to control the recorder.

This manual does not cover the communication functions. For details on communication function, see the *μ R10000/ μ R20000 Communication Interface User's Manual*, IM 04P01B01-17E.

Other Main Functions

The computation function (/M1 option) can be used to perform various computations from four arithmetic operations to statistical calculations on 8 and 12 computation channels on the pen model and dot model, respectively. The computed results can be recorded.

The remote control function (/R1 option) can be used to control the start/stop and other operations of the recorder by applying contact signals to the dedicated terminals.

The FAIL/chart end detection and output function (/F1 option) can be used to output contact signals when errors are detected on the recorder or when the chart paper runs out.

For the procedure to set the functions, see section 1.10, "Function Setup Guide."

1.2 Measuring Input Section

Input Section

Number of Measurement Channels and Scan Interval

The recorder samples the input signals on the measurement channels at the scan interval to obtain the measured values.

Model	Number of Channels	Scan Interval
1-pen model	1	125 ms
2-pen model	2	125 ms
3-pen model	3	125 ms
4-pen model	4	125 ms
Dot model	6	1 s (However, the scan interval is 2.5 s when the integration time of the A/D converter is 100 ms.)

Input Type, Measurable Range, and Computation

The recorder can measure the following types of inputs.

Input Type	Measurable Range
DC voltage	DC voltage in the range of ± 20 mV to ± 50 V
1-5V	See "1-5V" below.
Thermocouple	Temperature range corresponding to each type: R, S, B, K, E, J, T, N, W, L, U, and WRe
RTD	Temperature range corresponding to each type: Pt100 Ω and JPt100 Ω
ON/OFF input	Contact input: Open contact is OFF (0). Closed contact is ON (1). Voltage input: Less than 2.4 V is OFF (0). Greater than or equal to 2.4 V is ON (1). Within ± 6 V.

- **1-5V**

1-5V is scaled to values in the appropriate unit to be used as measured values. Also, the low-cut function (input less than 0% is fixed to 0% (scale left value)) can be used.

- **Current Input**

A shunt resistor is attached to the input terminal. The current signal is converted to a voltage signal and measured. The measurable range is the range equivalent to the "DC voltage" range indicated above after converting the current to the voltage signal.

Note

Three types of shunt resistors (250 Ω , 100 Ω , and 10 Ω) are available for current input (see "Optional Accessories (Sold Separately)" on page vii). For example, a 250- Ω shunt resistor is used to convert the signal to the range of 1 to 5 V for 4 to 20 mA input.

- **Range Type, Measurable Range, and Recording Span**

Various "range type" are available for the different types of inputs (for example thermocouple type R). Each range type has a preset measurable range (0.0 to 1760.0°C for thermocouple type R). Measurement can be made by specifying an arbitrary range within the measurable range as the *input range*. The measured values in the input range are recorded on the chart paper. The range of measured values that are recorded is called the *recording span*.

Measurable range (Thermocouple type R example)

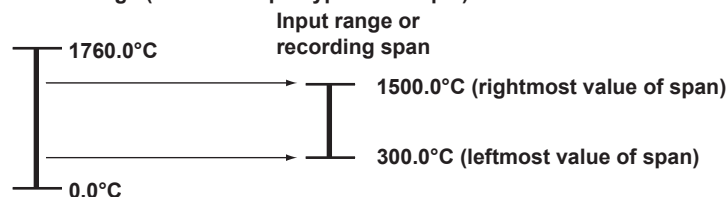

<Related Topics> Setting the input range: Section 5.1

For the procedure to set the functions, see section 1.10, "Function Setup Guide."

- **Delta Computation**

The value obtained by subtracting the measured value of another channel (called the *reference channel*) from the input value of the channel set to delta computation is used as the measured value of that channel. The reference channel must be assigned to a channel whose channel number is less than that of the channel on which delta computation is specified. The channel on which delta computation is specified is automatically set to the same range type as the reference channel.

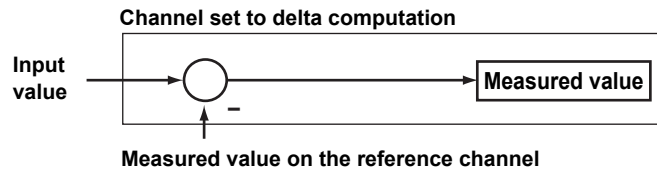

Note

A channel whose input type is set to DC voltage, TC, or RTD can be designated as a reference channel. However, channels set to scaling or square root computation cannot be designated.

- **Scaling**

The input values are scaled to values in the appropriate unit to be used as measured values.

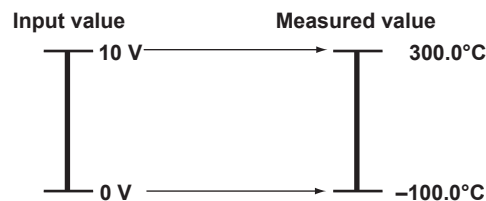

- **Square Root Computation**

When the input type is DC voltage, the square root of the input value is calculated, the result is scaled to a value in the appropriate unit, and used as the measured value of the channel. Also, the low-cut function (input less than a given measured value is fixed to 0% (scale left value)) can be used.

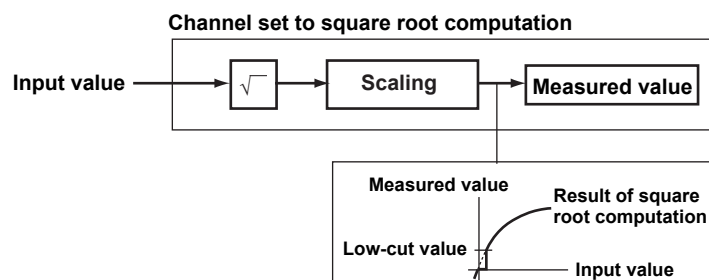

Note

The square root computation on the recorder uses the following formula.

$$F_x = (F_{max} - F_{min}) \sqrt{\frac{V_x - V_{min}}{V_{max} - V_{min}}} + F_{min}$$

where V_{min} (leftmost value of span) < V_{max} (rightmost value of span)

F_{min} (leftmost value of scale after scaling) < F_{max} (rightmost value of scale after scaling)

V_x is the input voltage and F_x is the scaled value

<Related Topics> Setting the input range: Section 5.1

For the procedure to set the functions, see section 1.10, "Function Setup Guide."

1.2 Measuring Input Section

- **Bias**

A given value (bias value) is added to the input value and used as the measured value of that channel.

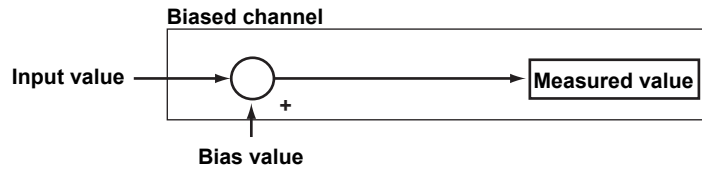

<Related Topics> Setting the bias: Sections 7.15 and 6.12

- **Calibration Correction (/CC1 Option)**

Corrects the measured value of each channel using segment linearizer approximation and makes the resultant value the measured value of the channel. You can set arbitrary correction values for 2 to 16 points of arbitrary measured values. Linear approximation is used between two segment points. Correction values can be assigned using revise values or absolute values.

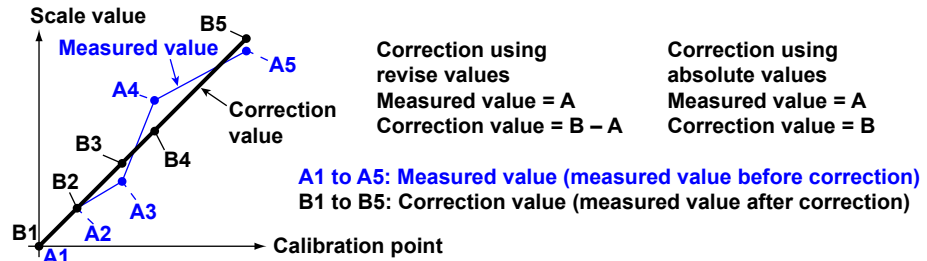

<Related Topics> Setting the calibration correction function: Sections 7.15, 7.23, and 6.13

Burnout Detection of Thermocouples

This function makes the recording go off the scale to the right or left when the thermocouple burns out while measuring temperature with a thermocouple. This function can also be used on 1-5V. The burnout detection function can be set for each channel. By default, this function is disabled.

Note

For 1-5V, a burnout occurs when the input value is less than or equal to 0.2 V.

<Related Topics> Setting the burnout detection function: Section 7.3

Reference Junction Compensation of Thermocouple Input

When measuring the temperature using a thermocouple, the reference junction compensation on the recorder can be used. When using external reference junction compensation, you can set the reference voltage. The reference junction compensation can be set for each channel.

By default, the recorder is configured to use the internal reference junction compensation function.

For the procedure to set the functions, see section 1.10, "Function Setup Guide."

Note

When using external reference junction compensation, set an appropriate reference junction compensation voltage. For example, if the reference junction temperature of the external reference compensation is T_0 °C, set the reference compensation junction voltage to the thermoelectromotive force of the 0°C reference of T_0 °C.

Example when using external reference junction compensation

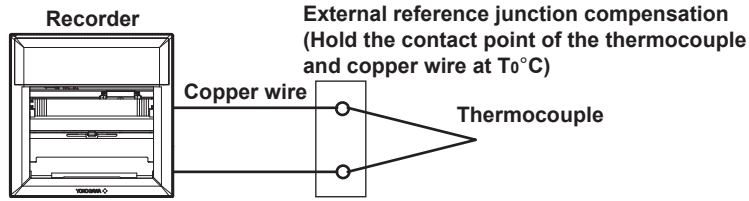

<Related Topics> Setting the reference junction compensation function: Section 7.4

Noise Elimination from Input Signals

Filter and Moving Average

This function used to suppress the effects of noise that is riding on the signal. The pen model and dot model are equipped with a filter function and a moving average function, respectively. The function can be set for each measurement channel. However, it does not operate on channels set to ON/OFF input.

• **Filter (Pen Model)**

The filter is a low-pass filter. The time constant can be set to 2 s, 5 s, or 10 s.

Filter result (output for a step input)

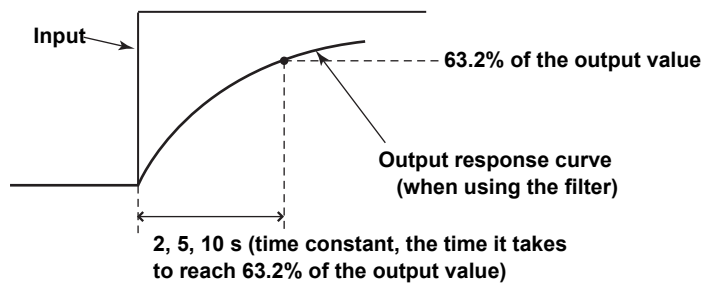

• **Moving Average (Dot Model)**

The average value of the m most recent values acquired at the scan interval is used as the measured value of the channel. The number of moving-averaged data points (m) can be set in the range 2 to 16. The figure below shows an example indicating the operation of the buffer for the moving average computation when the number of moving averaged data points is set to 5.

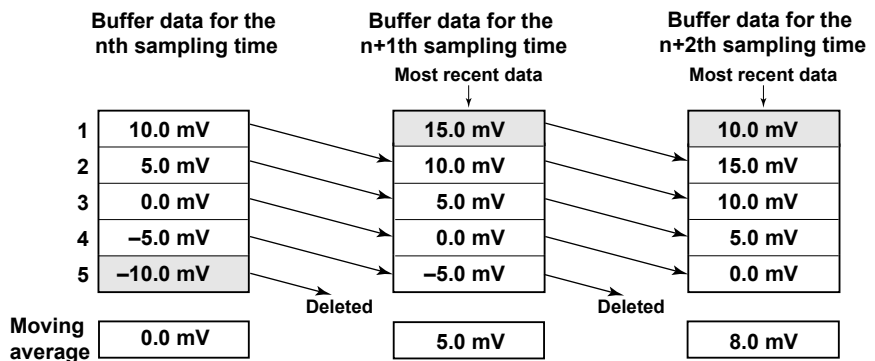

<Related Topics> Setting the filter: Sections 7.12 and 6.2

Setting the moving average: Sections 7.11 and 6.3

For the procedure to set the functions, see section 1.10, "Function Setup Guide."

Integration Time of the A/D Converter

The recorder uses an A/D converter to convert the sampled analog signal to a digital signal. By setting the integration time of the A/D converter to match the time period corresponding to one cycle of the power supply or an integer multiple of one cycle, the power supply frequency noise can be effectively suppressed.

The integration time of the A/D converter is selected according to the model from the table below.

Model	Integration Time of the A/D Converter
Pen model	Select 16.7 ms (60 Hz), 20 ms (50 Hz), or Auto
Dot model	Select 16.7 ms (60 Hz), 20 ms (50 Hz), 100 ms or Auto

- If Auto is selected, the recorder detects the power supply frequency and automatically selects 16.7 ms or 20 ms.
- If Auto is specified when using the 24-VDC power supply on a recorder with the 24-VDC/AC power supply (/P1 option), the integration time is fixed to 20 ms (50 Hz).
- Because 100 ms is an integer multiple of 16.7 ms and 20 ms, this setting can be used to suppress the power frequency noise for either frequency, 50 Hz or 60 Hz.
- The scan interval on the dot model is 1 s when the integration time is set to 16.7 ms or 20 ms and 2.5 s when the integration time is set to 100 ms.

<Related Topics> Setting the A/D integration time: Section 7.2

1.3 Alarms

This function generates an alarm when the measured data meets a certain condition. The alarm occurrence/release can be recorded on the chart paper. The alarm status can be displayed on the screen. Also, alarm output relays can be used to output contact signals when alarms occur (/A1, /A2, and /A3 options).

Alarm Types

Number of Alarm Point Marks

Up to four alarms can be set for each channel. The 4 alarm settings are called Level 1, Level 2, Level 3, and Level 4. The numbers do not indicate a difference in importance.

Alarm Conditions

The eight conditions below are available. The character inside the parentheses is the symbol used to denote each alarm on the recorder.

- **High Limit Alarm (H)**
An alarm occurs when the input value exceeds the alarm value.
- **Low Limit Alarm (L)**
An alarm occurs when the input value falls below the alarm value.

High limit alarm

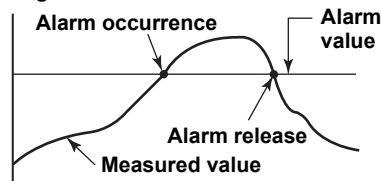

Low limit alarm

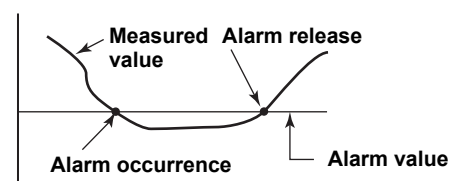

- **Difference High Limit Alarm (h)***
An alarm occurs when the difference in the input values of two channels is greater than or equal to the specified value.
- **Difference Low Limit Alarm (l)***
An alarm occurs when the difference in the input values of two channels is less than or equal to the specified value.
* Can be specified on channels set to delta computation.
- **High Limit on Rate-of-Change Alarm (R)**
The rate-of-change of the measured values is checked over a certain time (interval). An alarm occurs if the rate-of-change of the measured value in the rising direction is greater than or equal to the specified value.
- **Low Limit on Rate-of-Change Alarm (r)**
The rate-of-change of the measured values is checked over a certain time (interval). An alarm occurs if the rate-of-change of the measured value in the falling direction is greater than or equal to the specified value.

High limit on rate-of-change alarm

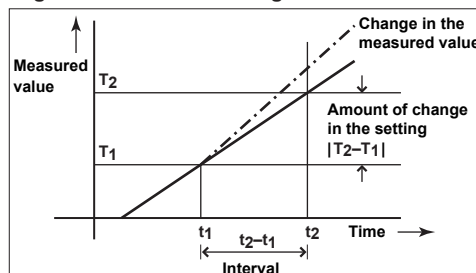

Low limit on rate-of-change alarm

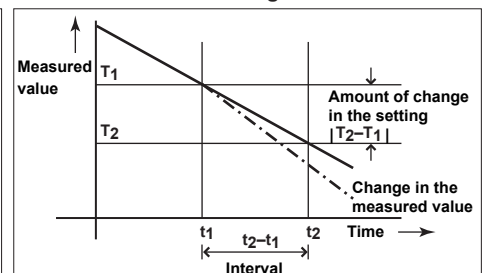

The alarm value of the rate-of-change alarm is set using an absolute value. The interval is derived using the following equation and set using the number of samples.

$$\text{Interval} = \text{the scan interval} \times \text{the number of samples}$$

For the procedure to set the functions, see section 1.10, "Function Setup Guide."

- **Delay High Limit Alarm (T)**
An alarm occurs when the measured value remains above the alarm value for a specified time period (alarm delay period).
- **Delay Low Limit Alarm (t)**
An alarm occurs when the measured value remains below the alarm value for a specified time period (alarm delay period).

Delay High Limit Alarm Example (T denotes the specified delay)

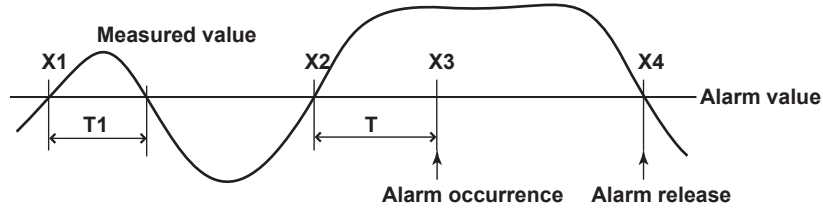

- Alarm does not occur at T1, because the time period is shorter than the specified alarm delay period (T).
- The measured value exceeds the alarm value at time X2, and the alarm occurs at time X3 at which the specified alarm delay period elapses (the time when the alarm occurs is the time at X3).
- The measured value falls below the alarm value at time X4, and the alarm is released.

Note

- The alarm detection operation is reset when a power failure occurs. The operation restarts after the power recovers.
- If the alarm value is changed while a delay alarm is occurring, the alarm is released if the new alarm value does not meet the alarm condition.

Alarm Hysteresis

Hysteresis can be specified to the values for activating and releasing the alarm. The hysteresis applies only to high limit alarm (H) and low limit alarm (L). The hysteresis width can be set in the range of 0.0% (Off) to 1.0% of the recording span in 0.1 steps. The setting applies to all high limit alarms and low limit alarms. By default, the hysteresis width is set to 0.5%.

High limit alarm

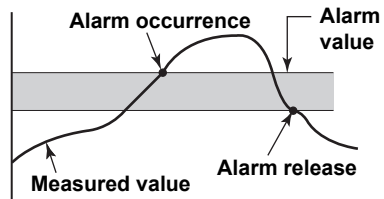

Low limit alarm

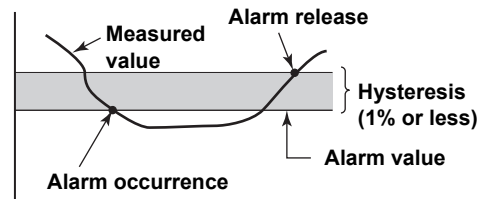

- <Related Topics> Setting alarms: Section 5.2
 Setting the alarm delay function: Sections 7.15 and 6.10
 Setting the alarm hysteresis: Section 7.1

For the procedure to set the functions, see section 1.10, "Function Setup Guide."

Alarm Indication

The alarm status can be displayed on the screen. For details on the display, see section 1.5.

Non-Hold/Hold Operation of the Alarm Indication

The alarm indication can be set to operate in the following fashion when the alarm condition is no longer met.

- Clear the alarm indication (non-hold).
- Hold the alarm indication until the alarm ACK operation is executed (hold).

The default setting is non-hold.

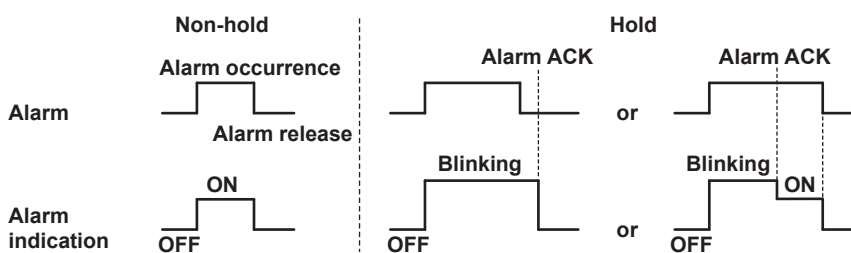

<Related Topics> Setting the non-hold/hold operation of the alarm indicator: Section 7.1

Alarm Recording

The alarm occurrence/release can be recorded on the chart paper. See section 1.4.

Alarm Output Relay (/A1, /A2, and /A3 Options)

Contact signals can be generated from alarm output relays when alarms occur. The number of output relays is 2 (/A1), 4 (/A2), or 6 (/A3). The alarm output relays are denoted as I01 to I06 on the recorder.

The following functions can be assigned to the alarm output relay.

Diagnosis Output

The diagnosis output can be assigned to alarm output relay I01.

The relay is activated when there is an error in the plotter operation on the pen model, when a burnout is detected, or when there is an error in the A/D converter. Output relay I01 is normally energized and de-energizes when an error is detected (de-energized operation and non-hold operation).

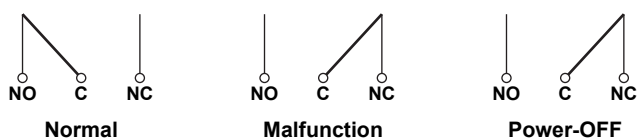

NO: Normally Opened, C: Common, NC: Normally Closed

Note

If diagnosis output is enabled, I01 becomes a relay dedicated to diagnosis output.

<Related Topics> Setting the diagnosis output: Section 7.1

For the procedure to set the functions, see section 1.10, "Function Setup Guide."

Reflash Alarm

When multiple alarms are assigned to one alarm output relay, this function notifies the occurrence of subsequent alarms after the relay is activated by the first alarm. When subsequent alarms occur, the output relay is released temporarily (approximately 500 ms).

The reflash alarm function is set to three output relays (I01, I02, and I03 (I01 and I02 for the /A1 option)).

By default, the reflash alarm is disabled.

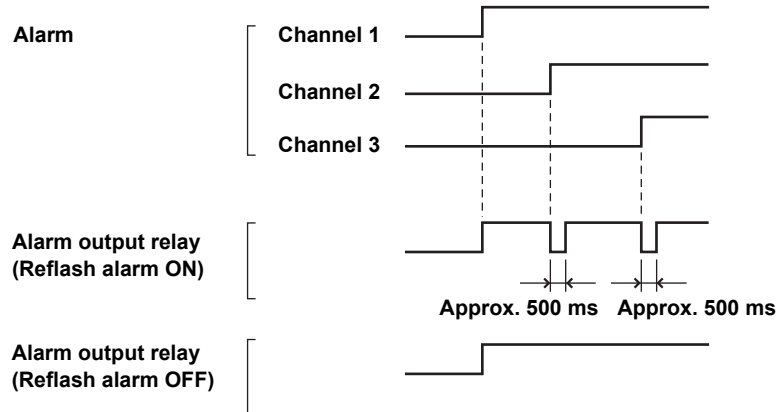

Note

- If the reflash alarm is enabled, I01 to I03 are set to reflash alarm operation. In this case, I01 to I03 are set to OR operation and non-hold operation regardless of the settings specified in “AND/OR Operation of Alarm Output Relays” and “Non-Hold/Hold Operation of Alarm Output Relays” described below.
- If diagnosis output is enabled, I01 is set to diagnosis output.

<Related Topics> Setting the reflash alarm: Section 7.1

AND/OR Operation of Alarm Output Relays

When multiple alarms are assigned to one alarm output relay, the condition for activating the alarm output relay can be selected from the following:

- AND: Activated when all assigned alarms are occurring simultaneously.
- OR: Activated when any of the specified alarms is occurring.

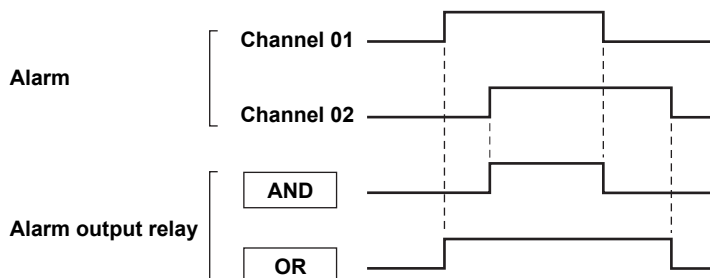

The alarm output relays assigned to AND operation are specified as follows: “I01 (first relay) to Ixx (where xx is the relay number).”

The default setting is “no AND relay.”

Note

- If the reflash alarm is enabled, I01 to I03 are fixed to OR operation. Specifying AND produces no effect.
- If diagnosis output is enabled, I01 is set to diagnosis output. Specifying AND produces no effect.

<Related Topics> Setting the AND operation: Section 7.1

Energized/De-energized Operation of Alarm Output Relays

You can select whether the alarm output relay is energized or de-energized when an alarm occurs. If de-energized is selected, the status of the alarm output relay when an alarm occurs is the same as the status that results when the recorder is turned OFF (including power failures). The setting applies to all alarm output relays.

The default setting is energized.

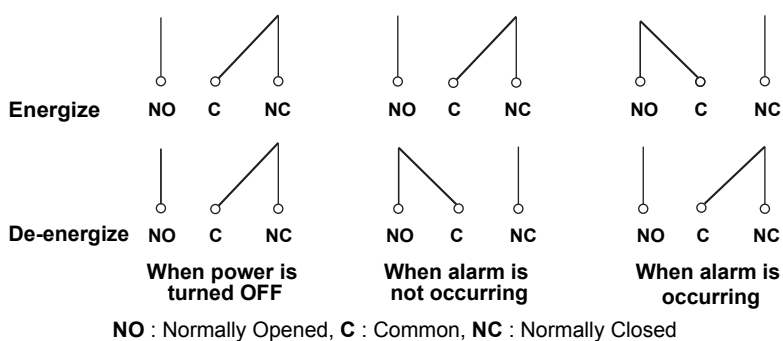

Note

If diagnosis output is enabled, I01 is fixed to de-energized operation.

<Related Topics> Setting the energized/de-energized operation of alarm output relays: Section 7.1

For the procedure to set the functions, see section 1.10, “Function Setup Guide.”

Non-Hold/Hold Operation of Alarm Output Relays

The alarm output relay can be set to operate in the following fashion when the alarm condition is no longer met.

- Turn off the relay output (non-hold).
- Hold the relay output until the alarm ACK operation is executed (hold).

The setting applies to all alarm output relays.

The default setting is non-hold.

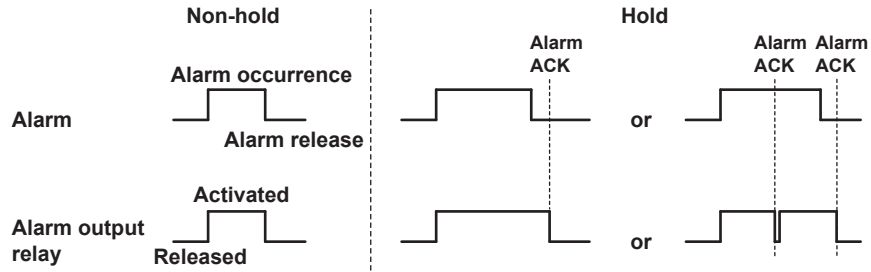

Note

- If the reflash alarm is enabled, I01 to I03 are fixed to non-hold operation. Specifying Hold produces no effect.
- If diagnosis output is enabled, I01 is fixed to non-hold operation. Specifying Hold produces no effect.

<Related Topics> Setting the non-hold/hold operation of alarm output relays: Section 7.1

Alarm ACK Operation

The alarm acknowledge (alarm ACK) operation releases all alarm indications and relay outputs (/A1, /A2, and /A3 options) that are activated when the alarm indication or alarm output relay is set to hold operation. This operation can be executed from the front panel key.

<Related Topics> Alarm ACK operation: Section 3.12

For the procedure to set the functions, see section 1.10, "Function Setup Guide."

1.4 Recording

The recorder is capable of recording the measured values with pens or dots (trend recording) as well as various other types of information.

Recording Example on the Pen Model

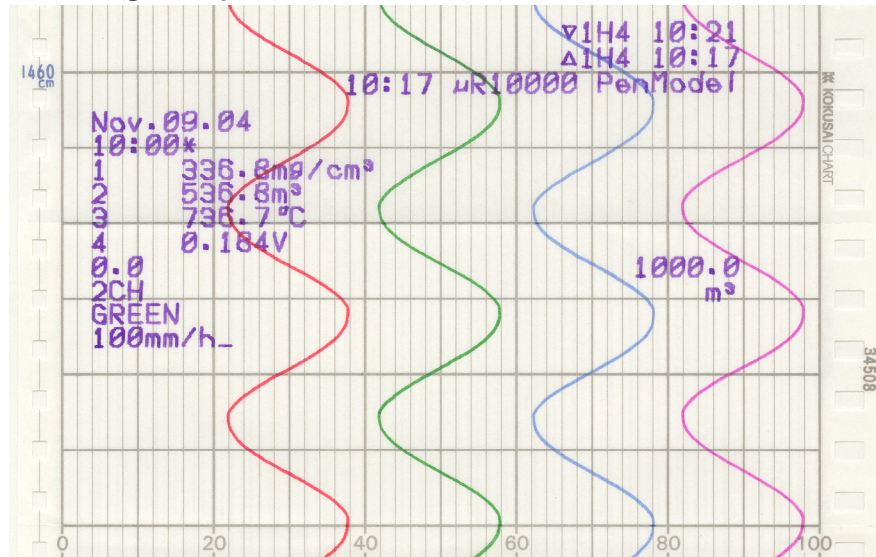

Recording Example on the Dot Model

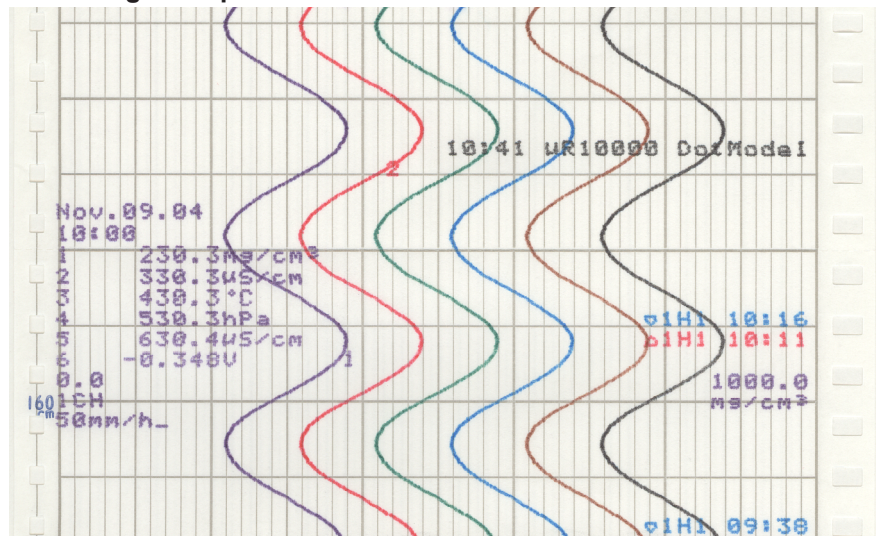

The recording examples may appear differently from the actual recording as a result of functional improvements made on the recorder after this manual was written.

<Related Topics> Starting/Stopping recording: Section 3.5

For the procedure to set the functions, see section 1.10, "Function Setup Guide."

Trend Recording

The measured values are printed within a width of 100 mm.

Recording Method (Pen Model)

- The measured value is updated every scan interval and continuously recorded.
- The recording colors in order from channel 01 are red, green, blue, and violet.

Recording Method (Dot Model)

- The most recent measured value is recorded with a dot every dot printing interval. The dot printing interval is in the range of 10 s to 90 s. There are two recording methods from which you can select. One method automatically adjusts the dot printing interval according to the chart speed so that the dots do not overlap. The other method records at the fastest dot printing interval at all times.
- The recording colors in order from channel 01 are purple, red, green, blue, brown, and black. The recording color of each channel can be changed among these six colors.
- For each channel, trend recording can be enabled or disabled.

<Related Topics> Setting the trend recording interval: Section 6.1
Changing the recording color: Section 7.5
Enabling/Disabling trend recording for each channel: Section 6.6

Chart Speed

On the pen model, the chart speed can be selected from 82 settings in the range of 5 to 12000 mm/h.

On the dot model, the chart speed can be set in the range of 1 to 1500 mm/h in 1-mm steps.

The default setting is 20 mm/h.

<Related Topics> Setting the chart speed: Section 5.4

Zone Recording

A recording zone is assigned to each channel. This function is useful such when the recording results overlap making them difficult to be viewed.

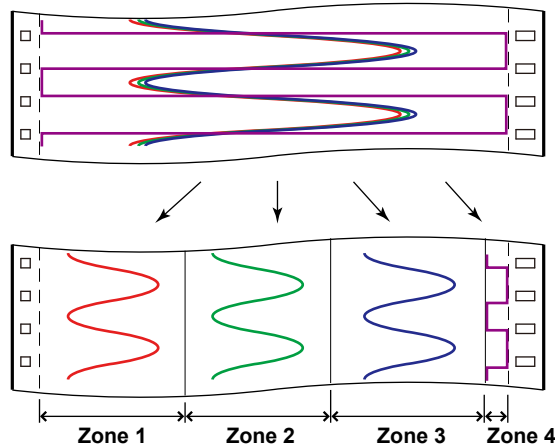

<Related Topics> Setting the zone recording: Section 6.4

For the procedure to set the functions, see section 1.10, "Function Setup Guide."

Partial Expanded Recording

This function expands a section of the recording range. By default, partial expanded recording is disabled.

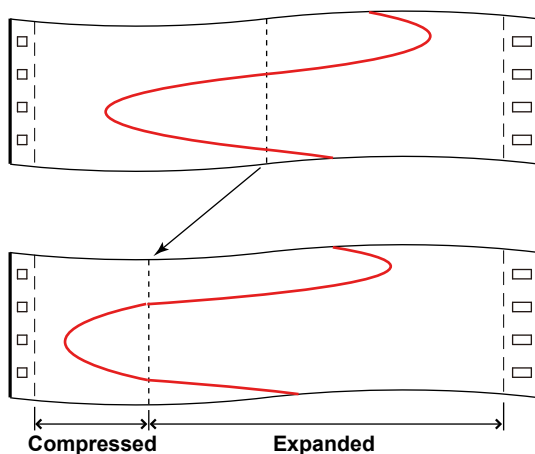

<Related Topics> Setting the partial expanded recording: Sections 7.13 and 6.5

Pen Offset Compensation (Pen Model)

This function compensates for the pen offset (phase difference) along the time axis. On 2-pen, 3-pen, and 4-pen recorders, there are offsets along the time axis (phase difference) between the pens. This offset is corrected when pen offset compensation is used.

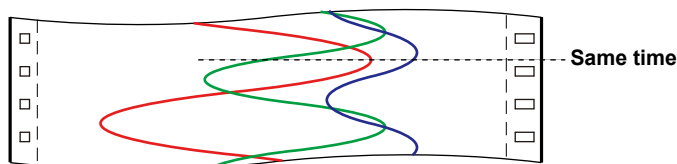

Below is an explanation for the 2-pen model.

The recording of these two pens are offset by an amount of phase P . If pen offset compensation is enabled, the measured values of pen 1 are stored in the memory, and recorded when the chart paper is fed by an amount corresponding to P .

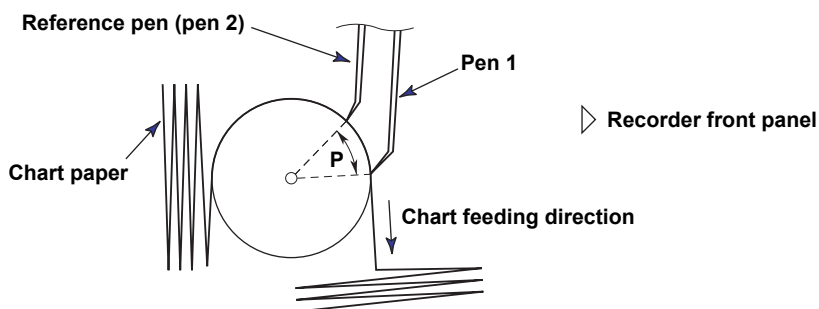

By default, this function is disabled.

<Related Topics> Setting the pen offset compensation: Section 7.6

Ejection of pen offset compensating data: "Header Printout (/BT1 Option) in section 1.4

For the procedure to set the functions, see section 1.10, "Function Setup Guide."

Printout

The figure below is used to explain the printout contents. The actual printout and font are different from those illustrated in the figure. The printout positions are also slightly different.

Printout Example on the Pen Model

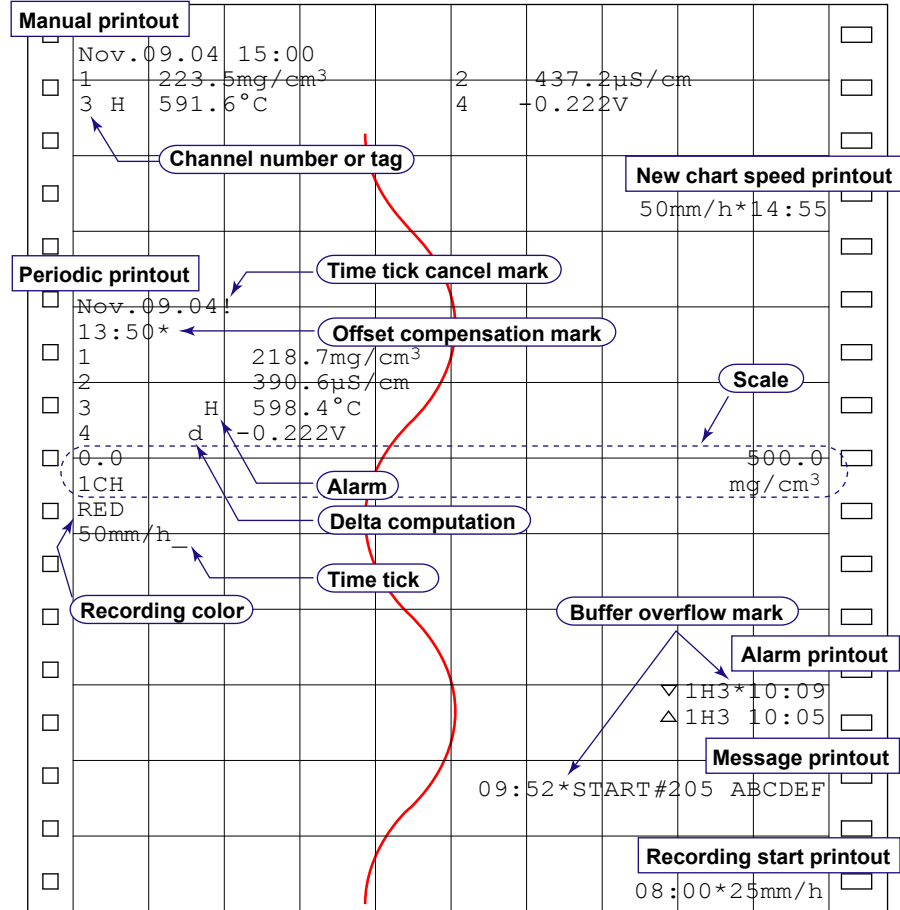

Time tick

A time tick is a mark that indicates the position of the date/time on the chart paper.

Time tick cancel mark

An exclamation point (!) is printed when the periodic printout time tick was not printed at the correct position.

Channel number or tag printout

Channel numbers or tags can be printed.

<Related Topics>

Switching between channel number printout and tag printout: Section 7.7

Setting the periodic printout (interval, reference time, types of measured values, and periodic printout ON/OFF): Section 7.8

Turning printout ON/OFF (alarm printout, recording start printout, new chart speed printout, scale printout for periodic printout, and recording color printout for periodic printout): Section 7.7

Setting the time format (alarm printout, message printout, recording start printout, and new chart speed printout): Section 7.16

Turning periodic printout ON/OFF for each channel: Section 6.6

Executing manual print: Section 3.7

Setting the message string and printing messages: Sections 6.8 and 3.10

Clearing the alarm printout buffer: Section 3.9

Printing settings: Section 3.8

For the procedure to set the functions, see section 1.10, "Function Setup Guide."

Printout Example on the Dot Model

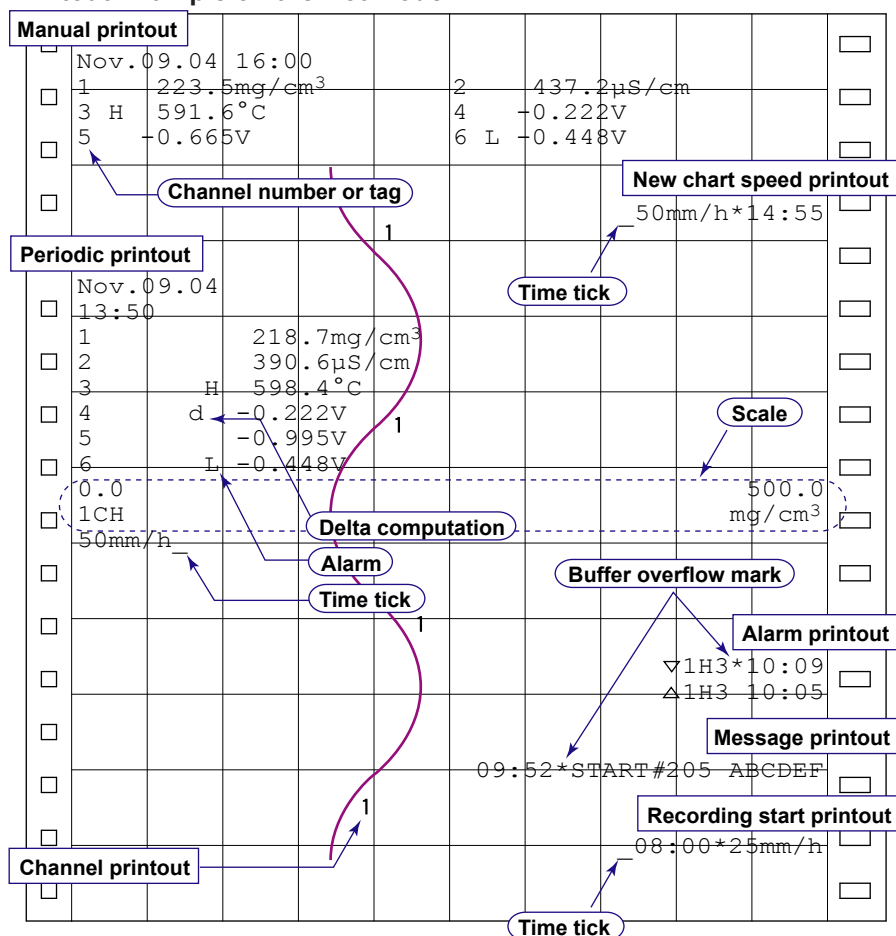
**Channel Printout (Dot Model Only)**

Prints the channel number or tag by the trend recording. The channel number or tag is printed every approximately 25 mm on the chart paper. The channel printout can be enabled or disabled. By default, the channel printout is enabled.

Characters may become discolored or the ribbon may brush against the paper due to the warping of the ink ribbon or the like during a digital printout. These do not occur during analog recording. Digital printout type: periodic printout, alarm/message printout, channel printout

<Related Topics>

- Switching between channel number printout and tag printout: Section 7.7
- Setting the periodic printout (interval, reference time, types of measured values, and periodic printout ON/OFF): Section 7.8
- Turning printout ON/OFF (channel printout, alarm printout, recording start printout, new chart speed printout, and scale printout for periodic printout): Section 7.7
- Setting the time format (alarm printout, message printout, recording start printout, and new chart speed printout): Section 7.16
- Turning recording and printout ON/OFF for each channel (trend recording and periodic printout): Section 6.6
- Executing manual print: Section 3.7
- Setting the message string and printing messages: Sections 6.8 and 3.10
- Clearing the alarm printout buffer: Section 3.9
- Printing settings: Section 3.8

For the procedure to set the functions, see section 1.10, "Function Setup Guide."

Alarm Printout

Alarm information is printed when an alarm occurs or releases.

Printout is not performed when the chart speed is as follows:

Pen model: 1600 mm/h or higher, dot model: 101 mm/h or higher

△ 1 H 2 * 1 0 : 0 0

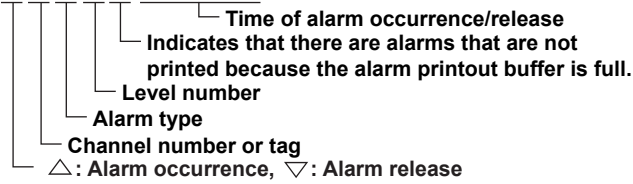

- The print condition can be set to (1) print when alarms occur and release, (2) print only when alarms occur, or (3) do not print.
- Alarms that occur while an alarm printout is in progress are temporarily saved to the buffer memory in a printout-wait condition. Alarms are cleared from the buffer memory when they are printed.
- The number alarms that can be stored in the buffer is 8 and 12 on the pen model and dot model, respectively. Alarms that occur while the buffer is full are not printed. A buffer overflow mark is printed when there are alarms that cannot be printed because the buffer is full.
- The time printout format can be selected.

Type	Printout format
Hour:Minute	10 : 00
Hour:Minute:Second	10 : 00 : 00
Month:Day:Hour:Minute	Nov. 09 10 : 00
Month:Day:Hour:Minute:Second	Nov. 09 00 : 00 : 00
Year:Month:Day: Hour:Minute:Second	Nov. 09. 2004 10 : 00 : 00

* The format of year, month, and day varies depending on the setting (see the next page).

Periodic Printout

Measured values and other items are printed at the preset interval.

Printout is not performed when the chart speed is as follows:

Pen model: Less than or equal to 9 mm/h or greater than or equal to 1600 mm/h

Dot model: 9 mm/h or less, 101 mm/h or greater

- **Printout Contents (for details, see appendix 1)**
 - Date/time, time ticks (marks that indicate the positions of the date/time on the chart paper); measured values, alarm status, scale (leftmost and rightmost values of span) and recording color (pen model) for each channel; and chart speed can be printed. When pen offset is being executed on the pen model, the pen offset marks are printed. On the pen model, if a time tick is not printed at the correct position, a time tick cancel mark (!) is printed.
 - Printout of measured values and alarm status can be enabled or disabled for each channel.
 - Printout of the scale and recording colors (pen model) can be enabled or disabled. The scale can be printed when the recording zone is greater than or equal to 40 mm.
 - The measured values for each channel can be selected from the following data types. Instantaneous value (measured value at the time of periodic printout)
 AVE (average of the measured values over an interval)
 MIN (minimum value of the measured values over an interval)
 MAX (maximum value of the measured values over an interval)
 MIX (minimum , maximum , and average value of the measured values over an interval)
 SUM (summed value of the measured values over an interval)
- **Interval (for details, see appendix 2)**
 The printout interval can be set by specifying the value or set automatically in sync with the chart speed.

For the procedure to set the functions, see section 1.10, "Function Setup Guide."

- **Turning ON/OFF the Periodic Printout**

Periodic printout can be turned ON/OFF. By default, periodic printout is enabled with the interval synchronized to the chart speed. Also, the measured values that are printed are the instantaneous values.

Manual Printout

The current measured values and alarm status as well as computed results when computation mode is on can be printed with keys.

When manual printout is executed, trend recording stops and restarts when manual printout is complete.

Message Printout

Printout is not performed when the chart speed is as follows:

Pen model: 1600 mm/h or higher, dot model: 101 mm/h or higher

Preset messages can be printed on the chart paper using the keys. Five messages, each within 16 characters, can be registered in advance.

- If message printout is executed while another message is being printed, the most recent message is temporarily stored to the buffer memory in a printout-wait condition. Messages are cleared from the buffer memory when they are printed.
- The number of messages that can be stored in the buffer is 5. If message printout is executed when the buffer is full, the message is not printed. A buffer overflow mark is printed when there are messages that cannot be printed because the buffer is full.
- The time printout format can be selected.

New Chart Speed Printout

Printout is not performed when the chart speed is as follows:

Pen model: 1600 mm/h or higher, dot model: 101 mm/h or higher

- When the chart speed is changed, the time tick (dot model), the date/time of change, and the new chart speed are printed. An asterisk (*) shows there are messages that cannot be printed.
- The time printout format can be selected.

Recording Start Printout

Printout is not performed when the chart speed is as follows:

Pen model: 1600 mm/h or higher, dot model: 101 mm/h or higher

When recording is started, the time tick (dot model), the time, and the chart speed can be printed. An asterisk (*) shows there are messages that cannot be printed.

- The recording start printout can be enabled or disabled. By default, the recording start printout is disabled.
- The time printout format can be selected.

Printout/Display Format of the Date (Version 1.11 or Later)

The printout/display format of the date can be selected from the list below. The setting applies to all dates printed and shown on the display. However, this does not apply to the format of the date printout of the message printout that include the measured values (/BT1 option).

Type	Printout/Display Format
Y/M/D	2005/08/31
M/D/Y	08/31/2005
D/M/Y	31/08/2005
D.M.Y	31.08.2005
M.D.Y	Aug.31.2005

<Related Topics> Setting the printout/display format of the date: Section 7.19

For the procedure to set the functions, see section 1.10, "Function Setup Guide."

Setting Printout

List or Setup List can be printed. When setting printout is executed, trend recording stops and restarts when the printout is complete.

List printout contains Setting Mode settings such as the input range and alarm for each channel.

Setup List contains Basic Setting Mode settings such as the alarm output relay operation and printout method.

• **Printout Example of List on the Pen Model**

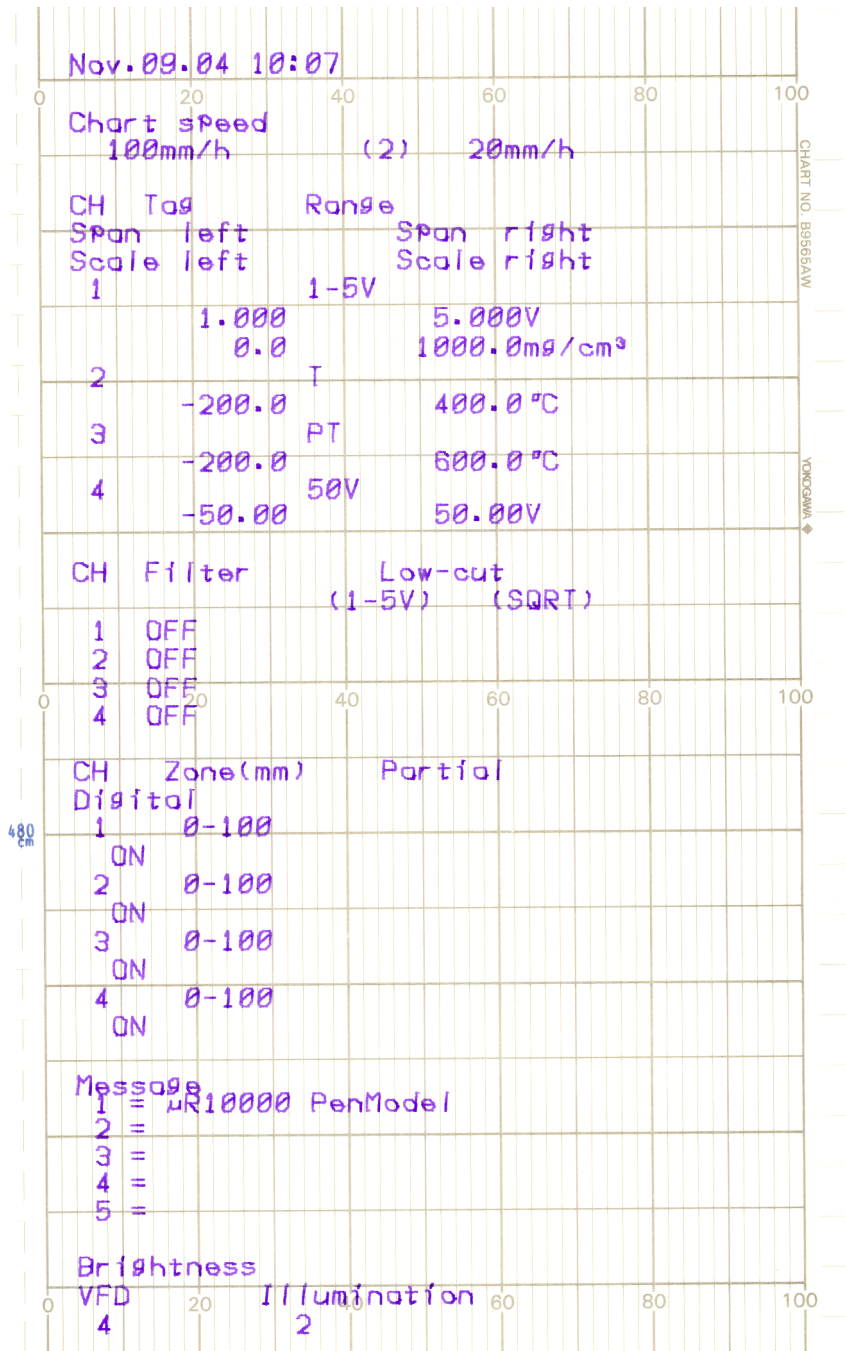

The printout examples may appear differently from the actual printout as a result of functional improvements made on the recorder after this manual was written.

For the procedure to set the functions, see section 1.10, "Function Setup Guide."

• Printout Example of List on the Dot Model

```

Nov.09.04 11:49
Chart speed
50mm/h (2) 20mm/h
Trend interval
Auto (18.0sec)
CH Tas Range
Span left Span right
Scale left Scale right
1 1-5V 5.000V
1.000 0.0 1000.0ms/cm2
2 T 400.0 °C
-200.0 PT
3 -200.0 600.0 °C
4 50V 50.00V
-50.00 20 40 60 80 100
5 2V
-2.000 2.000V
6 2V
-2.000 2.000V
CH Moving Ave Low-cut
(1-5V) (SQRT)
1 OFF
2 OFF
3 OFF
4 OFF
5 OFF
6 OFF
CH Trend Zone(mm) Partial
Digital
1 ON 0-100
2 ON 0-100
3 ON 20 40 60 80 100
4 ON 0-100
5 ON 0-100
6 ON 0-100
ON
Message
1 = μR10000 DotModel
2 =
3 =
4 =
5 =
Brightness
VFD Illumination
4 2
    
```

The printout examples may appear differently from the actual printout as a result of functional improvements made on the recorder after this manual was written.

For the procedure to set the functions, see section 1.10, "Function Setup Guide."

Header Printout (/BT1 Option)

When recording is started, the Start printout is performed, and recording starts. During trend recording, you can print out messages (up to 5) that include measured values.* When recording is stopped, End printout is performed.

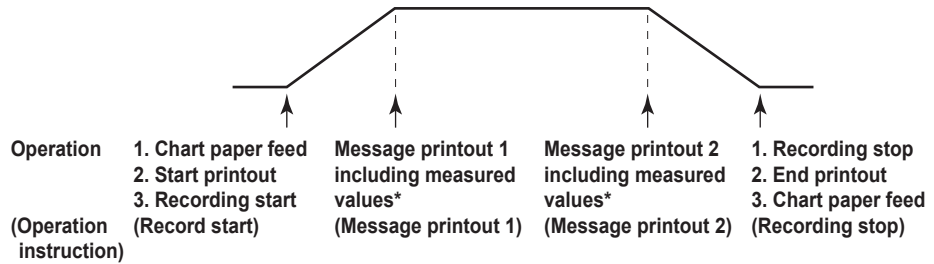

• Example Printout (Dot Model)

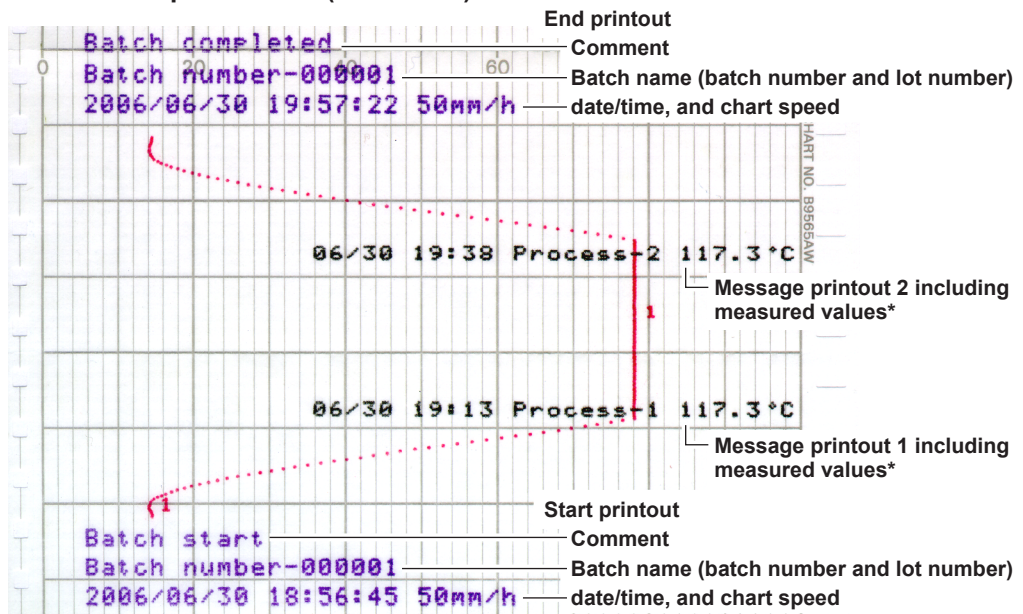

* Computed values can also be included on models with the /M1 option.

The printout examples may appear differently from the actual printout as a result of functional improvements.

Start Printout and End printout

When recording starts, “Start printout” or “Start printout 2” prints. Also, when recording stops, “End printout” or “End printout 2” prints.

Printout/Operation	Description	Notes
Comment	Prints 32 characters x 5 lines or less.	
Batch name		Can be displayed in the main display.
Batch number	Prints up to 26 characters.	
Lot number	Prints a number from 4-digits or 6-digits.	You can automatically increment by 1 when recording stops.
Date/time	The date format prints out according to the date printout/display format.	Date and time cannot be turned On/Off independently.
Chart speed	Prints the current chart paper feed speed.	
Chart paper feed	Feeds the chart paper 50 mm or less before Start printout. Feeds the chart paper 50 mm or less after End printout.	Steps of 1 mm Steps of 1 mm
Ejection of pen offset compensating data	You can record the portion of the data that remains after recording stops. Also, when recording the remaining portion of the data, you can change the chart speed to 450 mm/h (fixed).	When pen offset compensating is On (pen model).

You can select whether to print out the batch name, date/time, and chart speed. By default, the printout is enabled.

For the procedure to set the functions, see section 1.10, “Function Setup Guide.”

- **Switching between Start Printout and Start printout 2, and between End printout and End printout 2**

With the remote control function (/R1 option), you can change the items that are printed out.

For example, when a process ends successfully, End printout is performed and the lot number is updated. If the process fails, you can have End printout 2 be carried out and the lot number remain not updated.

Depending on the status of the “batch comment switching signal,” the following switches occur when the “record start/stop signal” switches:

Record Start/Stop Signal Status	Batch Comment Switching Signal Status	
	Level: 0 (Open)	Level: 1 (Closed)
Upon start Edge (rising)	Start printout	Start printout 2
Upon stop Edge (falling)	End printout	End printout 2

Remote Control Signal

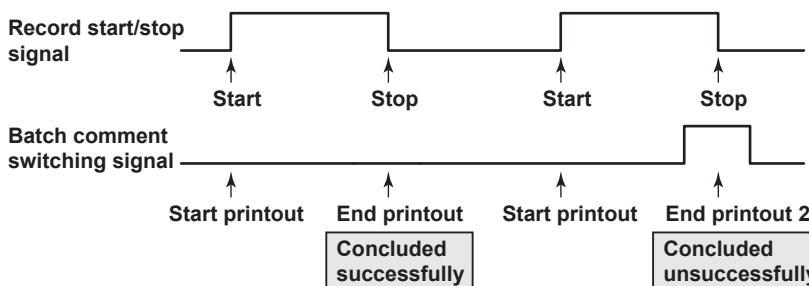

Message Printout Including Measured Values*

Following the specified message format, the date/time, message strings of the standard function (5 strings of up to 16 characters), and measured instantaneous values* are printed out together.

- Up to 5 messages of 35 characters can be entered.
- Messages are printed out in the order in which they are set.
- Message strings set with the standard function are specified as the first n number of characters from the start of the string. If a number of characters is specified more than once, the first instance is n number of characters from the start of the string, the second instance is n number of characters immediately after the first instance, and so on. And, for example, the character string set for message 1 can only be used once for message format 1.

Message Example

06/30 10:10 Process-1 134.8°C

Measured value* on CH1 (no units)
Character string set for message 1 of the standard function
Date/time

* Computed values can also be included on models with the /M1 option.

- <Related Topics> Setting the header printout: Sections 7.24 and 6.14
Assigning functions to the remote control input terminals: Section 7.18
Setting the message string: Section 6.8
Enabling the message format: Section 7.24
Setting the message format: section 6.15

SD Memory Card (/EM1 option)

Measured data can be saved to an SD memory card, and the data can be replayed on a chart paper (dot model only). The saved data can be used in the YOKOGAWA's Universal Viewer. In addition, recorder setup data can be saved to or loaded from an SD memory card. The setup data can be edited using the RXA10 Configuration Software. See the *μR10000/μR20000 SD Memory Card (/EM1 option) User's Manual*, IM 04P01B01-03E.

For the procedure to set the functions, see section 1.10, “Function Setup Guide.”

1.5 Display

Displayed Information

Main Display

The recorder is capable of displaying measured values, alarm information, and so on the VFD (Vacuum Fluorescent Display). Using normal fonts, 17 characters × 2 lines can be displayed. Using large fonts, 11 characters can be displayed.

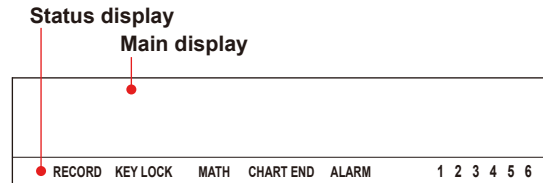

Various display types are available. Also, different displays can be assigned to the top and bottom sections of the main display. These display types can be registered to screens 1 to 15 and switched during operation using the keys.

Status Display

A status display is available at the bottom of the main display. The indicators below turn ON/OFF.

- **RECORD**
This indicator turns ON when recording is started and turns OFF when stopped.
- **ALARM 1 2 3 4 5 6**
The numbers correspond to measurement channel numbers. The indicator turns ON when an alarm occurs and turns OFF when the alarm is released.
If the alarm indication is set to hold operation, the indicator blinks when an alarm occurs. When alarm ACK operation is performed, the indicator turns ON or OFF.
- **MATH**
This indicator turns ON when computation on the computation function (/M1 option) is started and turns OFF when stopped.
- **KEYLOCK**
This indicator turns ON when key lock is enabled and turns OFF when disabled.
- **CHART END**
This indicator turns ON when the remaining amount of chart paper falls to approximately 2 cm on models with the FAIL/chart end function and output function (/F1 option).

Display Types

The following display types are available.

- Displays that show measured values
Measured values can be displayed numerically or using bar graphs. The channels that are displayed can be switched automatically at constant intervals.
The bar graph displays 0 to 100% using 101 points.



- Displays that show alarms
- Displays that show the date/time and chart speed
- Displays that show the remote control input and alarm output relay statuses (/R1 and /Ax options)
- Displays that show the status
- System display
- Batch name (/BT1 option)

Different display types can be assigned to the top and bottom sections of the main display.

For the procedure to set the functions, see section 1.10, "Function Setup Guide."

Several display examples are shown below. For details on the display types, see “Display Function Specifications” in section 12.4.

1 Channel Digital + 1 Bar Graph Display

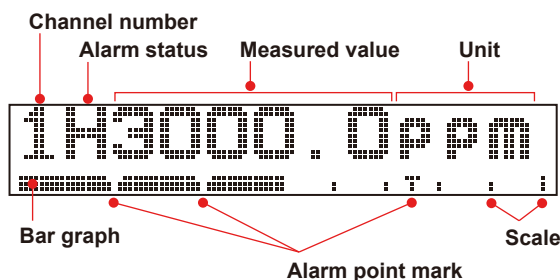

Flag Display

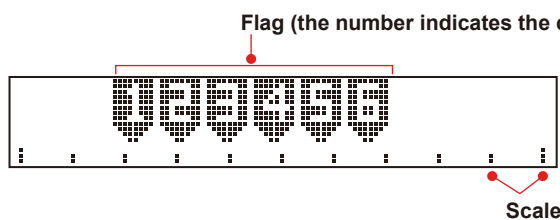

Alarm Status Display

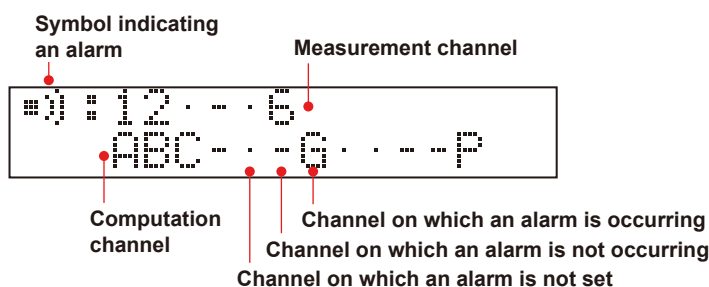

Date/Time and Chart Speed

The date format can be specified (see page 1-19).

Date

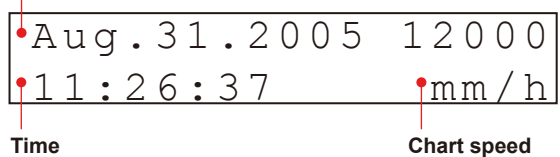

Status Display

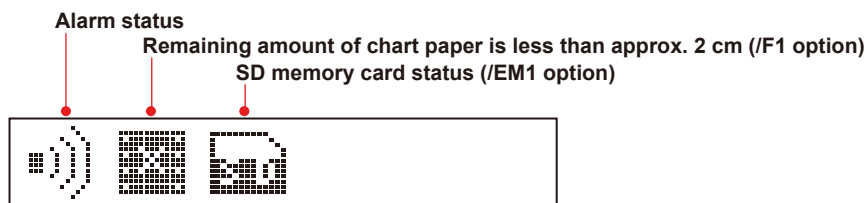

- <Related Topics>
- Assigning display types to screens: Chapter 8
 - Switching displays: Section 3.6
 - Setting the bar graph display mode: Section 7.9
 - Changing the date format: Section 7.19
 - Setting the display brightness: Section 6.11
 - Displaying measured values: Section 12.4.

For the procedure to set the functions, see section 1.10, “Function Setup Guide.”

1.6 Computation Function (/M1 Option)

Computation Function

Computing equations can be set up using measured values and other computed values as variables in computation-dedicated channels, and the computation can be executed. The computed result can be recorded. Computation is performed every scan interval.

Channels Dedicated to Computations

The computation-dedicated channels below can be used.

Model	Number of Channels	Channel Names
Pen model	8	0A, 0B, 0C, 0D, 0E, 0F, 0G, and 0J
Dot model	12	0A, 0B, 0C, 0D, 0E, 0F, 0G, 0J, 0K, 0M, 0N, and 0P

Types of Computations

In the table below, y represents the computed result. X and n represent the measured value, a constant, etc.

Type	Syntax in the Equation	Description
Four arithmetic operation	+, -, *, /	Determines addition, subtraction, multiplication, and division.
Power	**	Determines the power. $y = X^n$
Square root	SQR()	Determines the square root.
Absolute value	ABS()	Determines the absolute value.
Common logarithm	LOG()	Determines the common logarithm. $y = \log_{10}X$
Exponent	EXP()	Determines the exponent. $y = e^x$
Relational computation	.LT., .LE., .GT., .GE., .EQ., .NE.	Determines <, ≤, >, or ≥ of two elements and outputs "0" or "1."
Logical computation	AND, OR, XOR, NOT	Determines the AND (logical product), OR (logical sum), XOR (exclusive logical sum) of two elements, NOT (negation) of an element and outputs "0" or "1."
TLOG computation	TLOG.SUM(), TLOG.MAX(), TLOG.MIN(), TLOG.AVE(), TLOG.P-P()	Determines the sum (SUM), the maximum (MAX), the minimum (MIN), the average (AVE), and the maximum – minimum (P-P) at specified time intervals. There are three timers for setting the interval.

Data That Can Be Used in Equations

In TLOG computation, the measured values of measurement channels or computed values of computation channels can only be used. For all other computations, all of the data types below can be used.

- Measured Values on Measurement Channels**
 Specified by the channel number. For channels that have scaling enabled, the scaled values are used in the computation.
- Computed Values on Computation Channels**
 Specified by the channel number.
- Constants (K01 to K30)**
 The values assigned to K01 to K30 can be used as constants.
 Range of values (maximum significant digits is 5):
 -9.9999E+29 to -1.0000E-30, 0, 1.0000E-30 to 9.9999E+29

For the procedure to set the functions, see section 1.10, "Function Setup Guide."

- **Communication Input Data (Pen model: C01 to C08, dot model: C01 to C12)**

This data type is set using the communication interface (/C7 or /C3 option).

Range of values (maximum significant digits is 5):

–9.9999E+29 to –1.0000E–30, 0, 1.0000E–30 to 9.9999E+29

For the procedure of setting the communication input data, see the *μR10000/μR20000 Communication Interface User's Manual (IM04P01B01-17E)*.

- **Status of the Remote Control Input Terminal (D01 to D05, /R1 option)**

The status of the remote control input signal (1 or 0) can be used in the computation.

Use D01 to D05 (the number following the letter D is the remote control input terminal number) to specify the status in the equations.

<Related Topics> Setting the computing equation, constant, and unit: Sections 9.2 to 9.4
Setting the TLOG timer: Sections 9.6 and 9.12

Handing of the Unit in Computations

In computations, measured/computed values are handled as values without units. For example, if the measured value of channel 01 is 20 mV and the measured value of channel 02 is 20 V, the computed result of 01 + 02 is 40.

Recording Computation Channels

Trend Recording

Trend recording is possible by setting the recording span for each computation channel.

The recording span of computation channels can be set in the range of –9999999 to 99999999 excluding the decimal.

Zone recording and partial expanded recording are also possible.

Assignment of Computation Channels to the Pens (Pen Model)

Trend recording is possible by assigning computation channels to arbitrary pens. Only display or printout is possible for measurement channels or computation channels that are not assigned to a pen. Assignment of pens is possible only on models with the computation function.

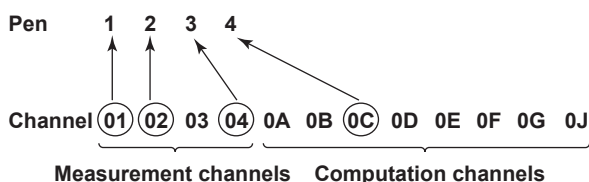

<Related Topics> Changing the channel assignment of recording pens: Section 9.14

Changing the Channel Recording Color (Dot Model)

The recording colors of computation channels can be changed. The default recording colors of channels are indicated below.

Recording color	Purple	Red	Green	Blue	Brown	Black
Computation channels	0A	0B	0C	0D	0E	0F
	0G	0J	0K	0M	0N	0P

For the procedure to set the functions, see section 1.10, "Function Setup Guide."

- **The Number of Channels Being Trend Recorded and the Fastest Recording Interval**

The fastest recording interval varies depending on the number of channels being trend recorded. Only display or printout is possible on measurement channels or computation channels that are not trend recorded.

Number of Channels Being Trend Recorded	Fastest Recording Interval
6 channels or less	10 s
7 to 12 channels	15 s
13 to 18 channels	20 s

<Related Topics> Changing the channel recording color: Section 9.13
Enabling/Disabling trend recording for each channel: Section 9.9

Printout

Various printouts can be executed in the same fashion as measurement channels. The computed values of computation channels can be printed at constant intervals by using the periodic printout timer or the two TLOG timers. The TLOG timers can be used only on the computation channels. For the printout contents when printing using the TLOG timer, see appendix 1.

<Related Topics> Setting the periodic printout: Sections 7.8, 9.6, and 9.15
Setting the printout using the TLOG timer: Sections 9.6 and 9.12

Alarms

Up to 4 alarms can be assigned to each computation channel.

- The alarm types are high limit alarm (H), low limit alarm (L), delay high limit alarm (T), and delay low limit alarm (t).
- Hysteresis can be specified to the values for activating and releasing the alarm. The hysteresis applies only to high limit alarm (H) and low limit alarm (L). The hysteresis width can be set in the range of 0.0% (Off) to 1.0% of the recording span in 0.1 steps. The setting applies to all high limit alarms and low limit alarms. By default, the hysteresis width is set to 0% (Off).

<Related Topics> Setting alarms: Section 9.5
Setting the alarm delay function: Sections 7.15 and 9.11
Setting the alarm hysteresis: Section 7.1

Display

Computation channels can be displayed on the VFD as with the measurement channels.

<Related Topics> Setting the bar graph display mode: Section 9.16

Starting/Stopping Computation

Computation can be started or stopped using keys.

<Related Topics> Starting/Stopping computation: Section 9.1

For the procedure to set the functions, see section 1.10, "Function Setup Guide."

1.7 FAIL/Chart End Detection and Output Function (/F1 Option)

FAIL Output

When a failure occurs in the CPU of the recorder, a relay contact signal (1 signal) is output. The relay is energized when the CPU is normal and de-energizes when a CPU failure occurs. Therefore, relay output is carried out also when the power is turned OFF (including a power failure). This relay behavior cannot be changed.

- **FAIL Relay Output**

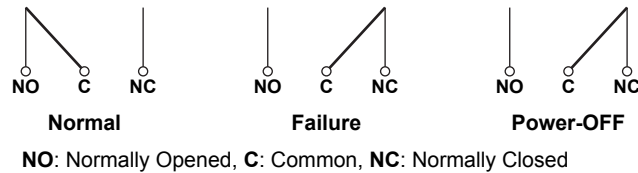
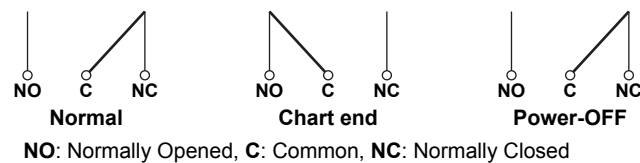

Chart End Output

When the remaining amount of chart paper falls to approximately 2 cm, recording is stopped, and the relay contact signal (1 relay) is output. The relay is energized in this case. This relay behavior cannot be changed.



For the procedure to set the functions, see section 1.10, "Function Setup Guide."

1.8 Remote Control Function (/R1 Option)

Specified operations can be carried out by applying remote signals (contact or open collector signals) to the remote control input terminals. There are five remote control input terminals. An action can be assigned to each terminal.

μR10000 Recorder

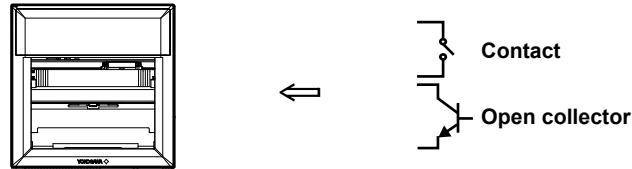

Assignable Functions

- **Recording start/stop**
 - Remote input signal: Rising edge signifies start; falling edge signifies stop
 - Starts/stops recording.
 - Applying a rising edge signal when recording is already in progress produces no effect. Applying a falling edge signal when recording is stopped produces no effect.
- **Chart Speed Switch**
 - Remote input signal: Level
 - The chart paper is fed at the secondary chart speed while a level signal is applied to the terminal. The secondary chart speed is set in advance.
- **Message 1 Printout to Message 5 Printout**
 - Remote input signal: Trigger
 - Prints message 1 to 5 on the chart paper.
- **Manual Printout**
 - Remote input signal: Trigger
 - Executes a manual printout.
- **Alarm ACK**
 - Remote input signal: Trigger
 - Alarm ACK is executed on all alarms that are occurring. This is valid only when the alarm indication or output relay operation is set to hold.
- **Internal Clock Adjustment**
 - Remote input signal: Trigger
 - The internal clock of the recorder is adjusted to the nearest hour depending on the time when the remote signal is applied.

Time When Signal Is Input	Adjustment
00 min 00 s to 01 min 59 s	Truncates the minutes and seconds. Example: 10 hours 01 min 50 s becomes 10 hours 00 min 00 s.
02 min 00 s to 57 min 59 s	The time is not changed.
58 min 00 s to 59 min 59 s	Rounds up the minutes and seconds. Example: 10 hours 59 min 50 s becomes 11 hours 00 min 00 s.

For the procedure to set the functions, see section 1.10, "Function Setup Guide."

- **Computation Start/Stop (/M1 Option)**
 - Remote input signal: Rising edge signifies start; falling edge signifies stop
 - Starts/stops the computation.
 - If the computation is started, applying a rising edge signal produces no effect. If the computation is stopped, applying a falling edge signal produces no effect.
- **Computation Reset (/M1 Option)**
 - Remote input signal: Trigger
 - The computed results of computation channels are reset. This is valid only while the computation is stopped. For all other cases, applying the remote signal produces no effect.
- **Priority to Remote Recording (/BT1 Option)**
 - Remote input signal: Edge (rising/start or falling/stop)
 - Starts/stops recording.
 - When started with a remote signal (on a remote signal rise), stop per key operation or communication is disabled.
- **Switching Batch Comment (/BT1 Option)**
 - Remote input signal: Level
 - Switches between Start printout and Start printout 2, and between End printout and End printout 2 depending on the status of the batch comment switching signal when recording is started/stopped remotely.
 - When starting/stopping by key operation, performs Start printout and End printout.
- **Starting and Stopping Data Saving (/EM1 Option)**
 - Remote input signal: Edge (rising/start or falling/stop)
 - Starts or stops data saving.
 - If data saving is in progress, applying a rising edge signal produces no effect. If data saving is not in progress, applying a falling edge signal produces no effect.

Remote Signal (Edge, Trigger, and Level)

The above actions are carried out on the rising or falling edge of the remote signal (edge), the ON signal lasting at least 250 ms (trigger), or the ON/OFF signal (level).

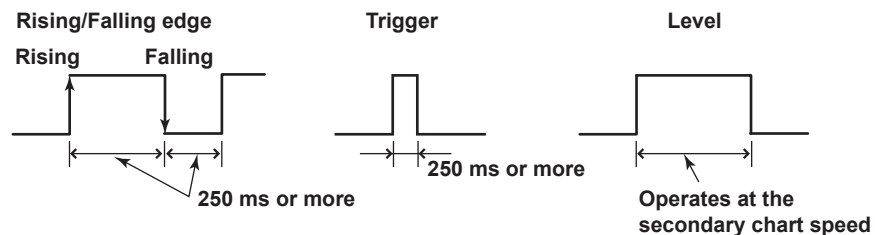

For contact inputs, the remote signal rises when the contact switches from open to closed and falls when the contact switches from closed to open. For open collector signals, the remote signal rises when the collector signal (voltage level of the remote control terminal) goes from high to low and falls when the collector signal goes low to high.

<Related Topics> Assigning functions to the remote control input terminals: Section 7.18
Setting the secondary chart speed: Section 6.9

For the procedure to set the functions, see section 1.10, "Function Setup Guide."

1.9 Other Functions

Key Lock

Key lock is a function that prohibits key operations. When key lock is enabled, pressing keys produces no effect. To release the key lock, a password is entered.

Key Lock Items

Each of the following keys can be included or excluded from the key lock function.

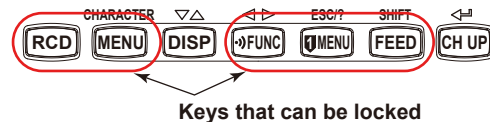

In the case of the FUNC key, each function of the FUNC key can be included or excluded from the key lock function.

FUNC key functions: Alarm ACK execution, computation start/stop (/M1 option), manual printout and setting printout, message printout, printout buffer clear, resetting of the periodic printout report data (the average, etc.), and pen replacement (pen model), ribbon cassette replacement (dot model), data saving start/stop (/EM1 option), data replay start/stop (/EM1 option), SD memory card ejection (/EM1 option)

<Related Topics> Setting the key lock function: Section 7.10
Using the key lock function: Section 3.13

Customize Menu

The menu can be customized to display only the menus that you use (version 1.31 or later).

- Display only the items that you use on the FUNC key menu.
- Display only the items that you use on the Setting mode menu.
- Lock Basic Setting mode (use a password to enter the mode).

The pen position adjustment (pen model) and dot printing position adjustment (dot model) can be set so that they can be used without the password.

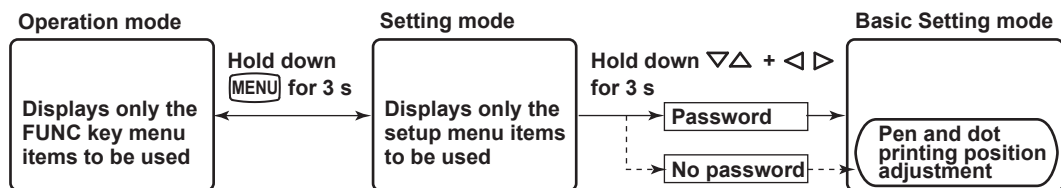

<Related Topics> Selecting the FUNC key menu: Section 7.20
Selecting the Setting mode menu: Section 7.21
Enabling/Disabling the customized menu: Section 7.22

Language

The display and recording language can be set to English, Japanese, German, or French.

- English: Alphabet, numbers, and symbols
 - Japanese: Alphabet, numbers, katakana, and symbols
 - German: German alphabet, numbers, and symbols
 - French: French alphabet, numbers, and symbols
- * German and French are supported on version 1.21 or later.

<Related Topics> Changing the language: Section 7.14

For the procedure to set the functions, see section 1.10, "Function Setup Guide."

DST

If the recorder is used in a region that has DST, time can be switched automatically between DST and standard time by setting the date/time when switching from the standard time to DST and the date/time when switching back from DST to standard time. When switching from standard time to DST, the clock is set ahead by 1 hour. When switching back from DST to standard time, the clock is set back by 1 hour.

<Related Topics> Using the DST: Section 6.16

Temperature Unit

The temperature unit can be set to Celsius or Fahrenheit. The setting applies to all channels.

<Related Topics> Changing the temperature unit: Section 7.25

For the procedure to set the functions, see section 1.10, "Function Setup Guide."

1.10 Function Setup Guide

This section explains the settings necessary to use various functions of the recorder. Read the section corresponding to the function you wish to use.

Note

This section contains all the settings related to each item. If the desired setting is the same as the default value, you do not have to set it.

Item	Description	Reference Section
Date/Time setting	Use Clock in Setting mode.	5.5
DST	Sets the date/time for switching between DST and standard time using Aux > DST in Setting mode.	6.16
Setting initialization	Use Initialize in Basic Setting mode to initialize the settings of Setting mode and Basic Setting mode to their default values.	7.17

Measuring input functions

Item	Description	Reference Section
Range and span of the TC, RTD, or DC voltage	Use Range in Setting mode.	5.1
1-5V	<ul style="list-style-type: none"> • Range, span, and scale Use Range in Setting mode. • Unit Use Unit in setting mode to set the unit after scaling. • Low-cut Use Personalize > Add function > 1-5V low-cut in Basic Setting mode and select Use or Not. If Use is selected, turn On/Off Low-cut using Range in Setting mode. If Not is selected, the Low-cut item does not appear in the Range setting. 	5.1 5.3 7.15 5.1
Scaling	<ul style="list-style-type: none"> • Range, span, and scale Use Range in Setting mode. • Unit Use Unit in setting mode to set the unit after scaling. 	5.1 5.3
Square Root Computation	<ul style="list-style-type: none"> • Range, span, and scale Use Range in Setting mode. • Unit Use Unit in setting mode to set the unit after scaling. • Low-cut Use Personalize > Add function > SQRT low-cut in Basic Setting mode and select Use or Not. If Use is selected, set the Low-cut point using Range in Setting mode. If Not is selected, the Low-cut item does not appear in the Range setting. 	5.1 5.3 7.15 5.1
Unused channels	Use Range > Skip in Setting mode to disable the trend recording (dot model) and periodic printout of the target channel.	5.1
Bias	Use Personalize > Add function > Bias in Basic Setting mode and select Use or Not. If Use is selected, set the bias value that is added to the input using Bias in Setting mode. If Not is selected, the Bias item does not appear.	7.15 6.12
Burnout detection function (TC input and 1-5V input)	Use Burnout in Basic Setting mode to set the burnout detection function for each channel.	7.3
RJC of TC input	Use RJC in Basic Setting mode to select whether to use the internal RJC function or an external RJC function.	7.4
Filter (pen model)	Use Filter in Basic Setting mode and select Use or Not. If Use is selected, set the filter time constant using Aux > Filter in Setting mode. If Not is selected, the Aux > Filter item does not appear.	7.12 6.2

Item	Description	Reference Section
Moving average (dot model)	Use Moving_AVE in Basic Setting mode and select Use or Not. If Use is selected, set the number of samples of moving average using Aux > Moving_AVE in Setting mode. If Not is selected, the Aux > Moving_AVE item does not appear.	7.11 6.3
Integration time of the A/D converter	Use A/D in Basic Setting mode to set the integration time of the A/D converter.	7.2
Temperature Unit	Select the temperature unit using Temperature in Basic Setting mode.	7.25

Alarm functions

Item	Description	Reference Section
Alarms for each channel	Use Alarm in Setting mode.	5.2
Delay high limit alarm/delay low limit alarm	<ul style="list-style-type: none"> Alarm type Use Personalize > Add function > Alarm delay in Basic Mode and select Use or Not. If Use is selected, delay high limit alarm (T) and delay low limit alarm (t) become selectable under Alarm > Type in Setting mode. If Not is selected, alarm delay cannot be selected. Alarm delay time Use Aux > Alm delay T in Setting mode to set the alarm delay time. 	7.15 5.2 6.10
High limit on rate-of-change alarm/low limit on rate-of-change alarm	Use Alarm in Setting mode and set the channel to rate-of-change alarm. Use Alarm > Increase in Basic Setting mode to set the interval of the high limit on rate-of-change alarm; use Alarm > Decrease in Basic Setting mode to set the interval of the low limit on rate-of-change alarm.	5.2 7.1
Use the alarm ACK operation	<ul style="list-style-type: none"> Relay operation and display operation Set Alarm > Behavior in Basic Setting mode to Hold and set Alarm > Indicator to Hold. Executing the alarm ACK operation Use Func > Alarm ACK in Operation mode to execute the release of the alarm output. 	7.1 3.12
Set a hysteresis on the alarm occurrence/release value of high limit alarm and low limit alarm	Use Alarm > Hysteresis in Basic Setting mode to set the hysteresis to be applied to the high limit alarm and low limit alarm of measurement channels. Likewise, use Alarm > M_Hysteresis to set the hysteresis to be applied to the high limit alarm and low limit alarm of computation channels (/M1 option).	7.1
Change the alarm output relay operation	If Alarm > Act in Basic Setting mode set to De_energize, alarm output relay is energized during normal operation and de-energized when an alarm occurs.	7.1
Diagnosis output	Use Alarm > Diagnosis in Basic Setting mode to set the function.	7.1

Recording functions

Item	Description	Reference Section
Chart speed	Use Chart in Setting mode to set the chart speed.	5.4
Turn trend recording ON/OFF (dot model)	Use Aux > Print out in Setting mode to set whether to trend record on each measurement channel.	6.6
Change the recording color of measurement channels (dot model).	Use Color in Basic Setting mode to set the recording color of measurement channels.	7.5
Record by compensating for the pen offset along the time axis (pen model)	Use Aux > POC in Setting mode to turn On/Off offset compensation.	7.6
Record by setting recording zone	Use Aux > Zone in Setting mode to set the recording zone for each channel.	6.4
Partial expanded recording	Use Partial in Basic Setting mode and select Use or Not. If Use is selected, set the display mode using Aux > Partial in Setting mode. If Not is selected, the Aux > Partial item does not appear.	7.13 6.5

1.10 Function Setup Guide

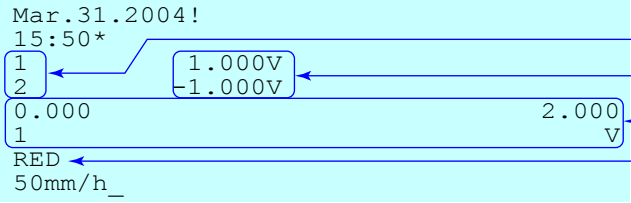
Item	Description	Reference Section
Periodic printout	 <ul style="list-style-type: none"> • Type of measured values to be printed/disable periodic printout Use Print1 in Basic Setting mode to set the type of measured values to be printed. You can select Inst, Report (statistical calculation value), or Off. 7.8 • If Report is selected, use Print2 in Basic Setting mode to select the report data type. 7.8 • Printout interval 7.8 Use Print 1 in Basic Setting mode to set the periodic printout interval. • Turn On/Off periodic printout for each channel 6.6 Use Aux > Print out in Setting mode to enable/disable the periodic printout on each measurement channel. • Scale printout and recording color printout (pen model) 7.7 Use Print > Scale in Basic Setting mode to turn scale printout On/Off. Use Print > Pen color in Basic Setting mode to turn pen color printout On/Off (pen model). 	
Tag printout	<ul style="list-style-type: none"> • Select channel printout or tag printout 7.7 Use Print > CH/Tag in Basic Setting mode to select whether to use channel numbers or tags in printouts. • Set the tag 6.7 Use Aux > Tag in Setting mode to set the tag name. 	
Tag display	In data display setup mode, select Screen No. > (the screen number) > Tag_1CH digital display, Tag_2CH digital display, Tag_1CH digital + 1CH bargraph, or Tag_1CH digital + 4CH bargraph. 8.2	
Alarm occurrence/release printout	<ul style="list-style-type: none"> • Turn printout On/Off 7.7 Use Print > Alarm in Basic Setting mode to select whether to print the alarm occurrence and release, print only the alarm occurrence, or not print. • Time printout format 7.16 Use Personalize > Time print > Alarm in Basic Setting mode to set the time printout format when printing alarm occurrence/release. 	
Recording Start Printout	<ul style="list-style-type: none"> • Turn printout On/Off 7.7 Use Print > Record On in Basic Setting mode to enable/disable the recording start printout. • Time printout format 7.16 Use Personalize > Time print > RCD On in Basic Setting mode to set the time printout format. 	
New chart speed printout	<ul style="list-style-type: none"> • Turn printout On/Off 7.7 Use Print > Chart speed in Basic Setting mode to set whether to print the new chart speed when the chart speed is changed. • Time printout format 7.16 Use Personalize > Time print > C. Speed in Basic Setting mode to set the time printout format. 	
Message printout	<ul style="list-style-type: none"> • Set the message string 6.8 Use Aux > Message to set the message string to be printed. • Time printout format 7.16 Use Personalize > Time print > Message in Basic Setting mode to set the time printout format. • Execute the message printout 3.10 Use Func > Message in Operation mode to execute the message printout. 	
Date format	Use Date format > Type in Basic Setting mode to set the printout/display format of the date. 7.19	
SD memory card (/EM1 option)	Use Data save in Setting mode to set how to start and stop data saving. IM04P Use Aux > Data replay to configure the recorder settings for replaying saved data on a chart paper using a dot model. 01B01-03E	

Display functions

Item	Description	Reference Section
Display brightness	Use Aux > Brightness > Display in Setting mode to set the display brightness.	6.11
Bar graph display mode	Use Bar graph in Basic Setting mode to set the bar graph display mode.	7.9
Display type	Assigns the display type on the data display setup Screen No.	Chapter 8
Date format	Same as the Date format in "Recording functions."	7.19

Other functions

Item	Description	Reference Section
Key lock	• Target keys and password Use Keylock in Basic Setting mode to set the keys to be key-locked and the password.	7.10
	• Enable the key lock Use Func > Keylock in Operation mode and select Use or Not.	3.13
Customized menu	• Selecting the FUNC key display menu Use Select menu > Function in Basic Setting mode to select the menus to be displayed.	7.20
	• Selecting the displayed menu of Setting mode Use Select menu > Set mode in Basic Setting mode to select the menus to be displayed.	7.21
	• Executing the customize menu Use Cust. menu in Basic Setting mode to set whether to use the customized menu. If Use is selected, only the menus set to ON in the menu selection are displayed, and Basic Setting mode is locked. If Not is selected, all menus are displayed, and the Basic Setting mode lock is released.	7.22
Language	Use Language in Basic Setting mode to set the display and printout language.	7.14
Internal light brightness	Use Aux > Brightness > Light in Setting mode to set the internal light brightness.	6.11

Computation function (/M1 option)

Item	Description	Reference Section
Computing equation and recording span	Use Math > Formula in Setting mode to set the computing equation and recording span for each channel.	9.2
	TLOG computation	If TLOG computation is selected, use Math > Timer in Basic Setting mode to set the timer operation Use Math > TLOG > Timer No. in Setting mode to set the timer used on each computation channel.
Unit	Use Math > Unit in Setting mode to set the unit for each channel.	9.3
Constants	Use Math > Constant in Setting mode to define constants to be used in the computing equations.	9.4
Alarms	Use Math > Alarm in Setting mode to set the alarm for each channel.	9.5
	• Delay high limit alarm/delay low limit alarm • Alarm type Use Personalize > Add function > Alarm delay in Basic Mode and select Use or Not (common with measurement channels). If Use is selected, delay high limit alarm and delay low limit alarm become selectable under Math > Alarm > Type in Setting mode. If Not is selected, alarm delay cannot be selected.	7.15
	• Alarm delay time Use Math > Aux > Alm delay T in Setting mode to set the alarm delay time.	9.11
Record by setting recording zone	Use Math > Aux > Zone in Setting mode to set the recording zone for each channel.	9.7
Partial expanded recording	Use Partial in Basic Setting mode and select Use or Not.	7.13
	If Use is selected, set the display mode using Math > Aux > Partial in Setting mode. If Not is selected, the Math > Aux > Partial item does not appear.	9.8
Change the recording color (dot model)	Use Color in Basic Setting mode to set the recording color of each computation channel.	9.13

1.10 Function Setup Guide

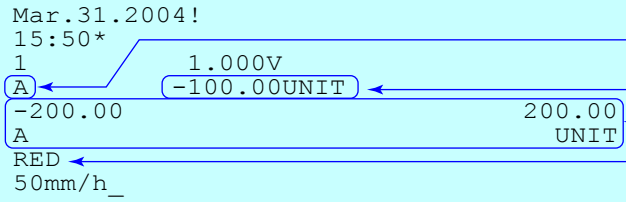
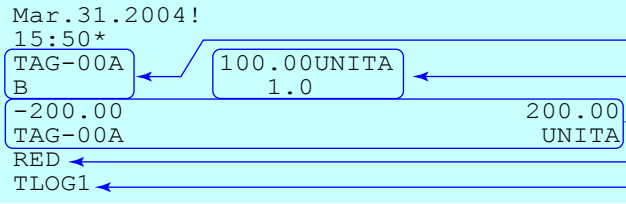
Item	Description	Reference Section
Recording pen assignment (pen model)	Assigns measurement/computation channels to the recording pens.	9.14
Turn trend recording ON/OFF (dot model)	Use Math > Aux > Print out > Trend in Setting mode to set whether to trend record each computation channel.	9.9
Periodic printout	 <p> <ul style="list-style-type: none"> • Type of computed values to be printed/disable periodic printout Common with measurement channels. 7.8 • If Report is selected, use Math > Print2 in Basic Setting mode to select the report data type. 9.15 • Printout interval 7.8 <ul style="list-style-type: none"> Set Math > TLOG > Timer No. in Setting mode to Periodic. The interval is common with measurement channels. • Turn On/Off periodic printout for each channel 9.9 <ul style="list-style-type: none"> Use Math > Aux > Print out > Periodic in Setting mode to enable/disable the periodic printout for each computation channel. • Scale printout and recording color printout (pen model) Common with measurement channels. 7.7 </p>	
Periodic printout using TLOG timer (dedicated to computation channels)	 <p> <ul style="list-style-type: none"> • Use Math > Timer (TLOG) in Basic Setting mode to set the printout interval. 9.12 • Use Math > Timer (TLOG) > Print in Basic Setting mode to turn the printout On. 9.12 • Use Math > Aux > Print out > Periodic in Setting mode to enable/disable the periodic printout for each computation channel. 9.9 • Set Math > TLOG > Timer No. in Setting mode to set the timer used on each computation channel. 9.6 • Scale printout and recording color (pen model) Common with periodic printout. 7.7 </p>	
Alarm occurrence/release printout	Common with measurement channels.	7.7
Tag	<ul style="list-style-type: none"> • Channel/tag selection Common with measurement channels. 7.7 • Tag name 9.10 <ul style="list-style-type: none"> Use Math > Aux > Tag in Setting mode to set the tag name. 	
Bar graph display mode	Use Math > Bar graph in Basic Setting mode to set the bar graph display mode.	9.16
Procedure when computed results are in error	Use Math > Error data in Basic Setting mode to set the procedure taken when the computed results are in error.	9.17

Remote control function (/R1 option)

Item	Description	Reference Section
Remote control function (/R1 option)		
	<ul style="list-style-type: none"> Assign functions to the remote control input terminals Use Remote in Basic Setting mode to set the function to be assigned to the remote control input terminal. 	7.18
	<ul style="list-style-type: none"> Secondary chart speed If "chart speed switching" is assigned, use Aux > Chart 2 in Setting mode to set the secondary chart speed. 	6.9
	<ul style="list-style-type: none"> Switching between start printout and start printout 2 and between end printout and end printout 2 (/BT1 option) If BatchCMT switch is assigned Use Batch > Dual comment in Basic Setting mode to enable or disable start printout 2 and end printout 2. 	7.24
	<ul style="list-style-type: none"> If Use is selected, set Batch > Detail > Start2 and End2 in Setting mode. If Not is selected, the Batch > Detail > Start2 and End2 items in Setting mode do not appear. 	6.14

Calibration Correction (/CC1 Option)

Item	Description	Reference Section
Calibration correction function		
	Use Personalize > Add function > Calibration in Basic Setting mode and select Use or Not.	7.15
	If Use is selected,	
	<ul style="list-style-type: none"> Use Calibration in Basic Setting mode to set the correction mode and the number of calibration points. 	7.23
	<ul style="list-style-type: none"> Use Calibration in Setting mode to set the measured value and correction value for each channel. 	6.13
	If Not is selected, the Calibration item does not appear.	

Header Printout (/BT1 Option)

Item	Description	Reference Section
Setting start printout and end printout		
	Use Batch in Basic Setting mode to set whether to use the start printout and end printout. If Use is selected, select a Lot No. from 4 digits, 6 digits, or OFF.	7.24
	If Use is selected,	
	<ul style="list-style-type: none"> Use Batch > Batch No. in Setting mode to set the batch number. Use Batch > Lot No. in Setting mode to set the lot number. Use Batch > Detail > Start, End in Setting mode. 	6.14
	If Not is selected, the Batch > Lot No. item in Basic Setting mode and the Batch item in Setting mode do not appear.	
Switch between start printout and start printout 2 and between end printout and end printout 2 (/R1 option)		
	<ul style="list-style-type: none"> Switch settings Assign "BatchCMT switch" to the remote control input terminal. 	7.18
	Use Batch > Dual comment in Basic Setting mode to set whether to use start printout 2 and end printout 2.	7.24
	If Use is selected, set Batch > Detail > Start2 and End2 in Setting mode.	6.14
	If Not is selected, the Batch > Detail > Start2 and End2 items in Setting mode do not appear.	
	<ul style="list-style-type: none"> Executing the switch The switch occurs according to the status of the "BatchCMT switch" signal when "Record On/Off" or "Priority R_RCD" signal assigned to the remote control input terminal rises or falls. 	1.4
Printout of messages including measured/computed values		
	<ul style="list-style-type: none"> Setting message strings Use Aux > Message in Setting mode to enter the message to print out. 	6.8
	<ul style="list-style-type: none"> Setting the message format Use Batch > MSG format in Basic Setting mode and select whether to use the message format. 	7.24
	If Use is selected, use Batch > MSG format > Message No. in Setting mode to set the message format.	6.15
	If Not is selected, the Batch > MSG format item does not appear.	
	<ul style="list-style-type: none"> Executing message printout Use Func > Message in Operation mode to execute the message printout. 	3.10

Blank

2.1 Handling Precautions

This section describes the precautions to be taken when using the recorder. Read this section before use.

Handling Precautions

- Use care when cleaning the recorder, especially any plastic parts. When cleaning, wipe using a dry soft cloth. Do not use chemicals such as benzene or thinner, since these may cause discoloring and deformation.
- Keep electrically charged objects away from the recorder as this may cause malfunction.
- Do not apply volatile chemicals to the door glass, display, panel keys, etc. Do not allow rubber and vinyl products to remain in contact with the recorder for long periods of time. This may damage the recorder.
- When not in use, make sure to turn OFF the power switch.
- If there are any symptoms of trouble such as strange odors or smoke coming from the recorder, immediately turn OFF the power switch and the power supply source. Then, contact your nearest YOKOGAWA dealer.

2.2 Installation

Installation Location

Install the recorder indoors in a location that meets the following conditions. See also the normal operating conditions described in section 12.6, "General Specifications."

- **Instrument Panel**

The recorder is designed for panel mounting. The portable type (/H5x option) is designed to be used on the desktop.

- **Well-Ventilated Location**

To prevent overheating, install the recorder in a well-ventilated location.

For the panel cut dimensions when arranging multiple recorders, see section 12.7.

Follow the panel cut dimensions providing adequate space between instruments when other instruments are arranged on the panel. We recommend that you secure at least 50 mm of space from the left, right, top, and rear panels on the portable type (/H5x option).

- **Minimum Mechanical Vibrations**

Choose an installation location with the minimum mechanical vibration.

Installing the recorder in a location with large mechanical vibration not only causes adverse effects on the mechanism but also may hinder normal recording.

- **Horizontal**

Install the recorder horizontally (However, the recorder can be inclined up to 30 degrees backwards for panel mounting).

- **Ambient temperature range between 0 to 50°C**

- **Ambient humidity between 20 to 80%RH (at 5 to 40°C) or 30 to 50%RH (at 0 to 5, 40 to 50°C), No condensation should be present.**

- **Altitude 2000 m or less**

Note

- Condensation may occur if the recorder is moved to another place where both the ambient temperature and humidity are higher, or if the temperature changes rapidly. In addition, measurement errors will result when using thermocouples. In this case, let the recorder adjust to the new environment for at least one hour before using it.
 - The chart paper may be adversely affected by a rapid change in the ambient temperature and humidity.
-

Do not install the instrument in the following places.

- **Outdoors**

- **In direct sunlight or near heat sources**

Install the recorder in a place with small temperature fluctuations near room temperature (23°C). Placing the recorder in direct sunlight or near heat appliances can cause adverse effects on the internal circuitry.

- **Where an excessive amount of soot, steam, moisture, dust, or corrosive gases are present**

Soot, steam, moisture, dust, and corrosive gases will adversely affect the recorder. Avoid such locations.

- **Near Strong Magnetic Field Sources**

Do not bring magnets or instruments that produce electromagnetic fields close to the recorder. Operating the recorder in strong magnetic fields can cause errors in the measurements.

Installation Procedure

The recorder should be mounted on a steel panel of thickness 2 mm to 26 mm.

1. Insert the recorder from the front side of the panel.
2. As shown in the figure below, mount the recorder to the panel using the mounting brackets that come with the package.
 - Use two brackets to support the top and bottom or the left and right sides of the case. (Remove the seal that is covering the holes for the mounting brackets beforehand.)
 - The proper torque for tightening the mounting screws is 0.7 to 0.9 N•m.
 - Mount the recorder to the panel according to the procedure below.
 - First, attach the two mounting brackets and temporarily fasten the attachment screws.
 - Next, fix the recorder in place by tightening the attachment screws with the appropriate torque. When the recorder is approximately perpendicular to the panel as you fasten the screws, press the mounting bracket against the case so that they are in contact with each other.

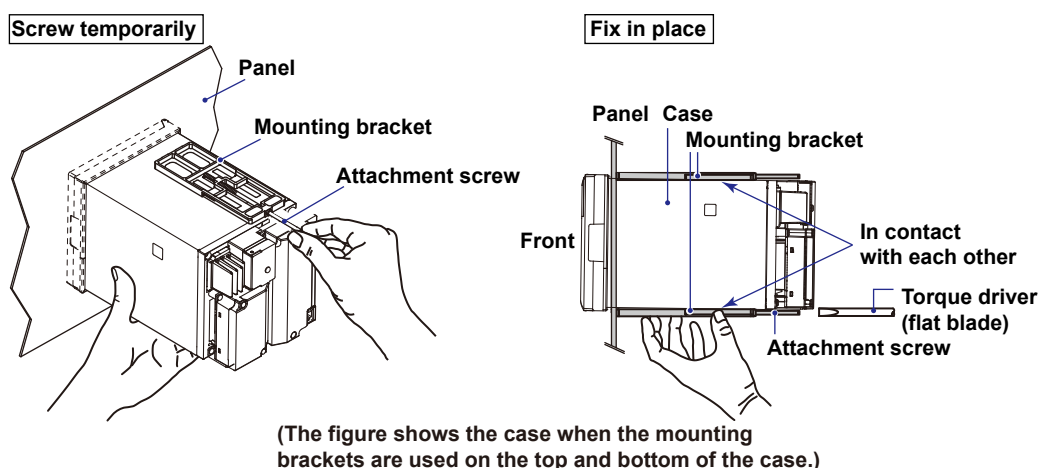

CAUTION

Tightening the screws too much can deform the case or damage the bracket.

For the dimensional drawings and panel cut dimensions, see section 12.7.

2.3 Input Signal Wiring

General Precautions to Be Taken While Wiring



WARNING

To prevent the possibility of electric shock when wiring, make sure that the power supply source is turned OFF.



CAUTION

- The input terminals of this instrument are specific to this instrument. Do not connect the input terminals of the μ R1000, μ R1800 or other models, as malfunction may result.
- If a strong tension is applied to the cable wired to the recorder, the terminals of the recorder and/or the cable can be damaged. In order to prevent tension from being applied directly on the terminals, fasten all wiring cables to the rear of the mounting panel.
- Do not apply a voltage exceeding the following value to the input terminals as this may damage the recorder.
 - Maximum input voltage
Voltage range less than or equal to 200 mVDC, TC, RTD, and DI: ± 10 VDC
Ranges other than those listed above: ± 60 VDC
 - Maximum common-mode voltage
 ± 60 VDC (under measurement category II conditions)

Precautions to Be Taken While Wiring

Take the following precautions when wiring the input signal cables.

It is recommended that crimp-on lug with insulation sleeves (designed for 4-mm screws) be used when connecting the input/output signal wires to the terminals. However, this does not apply to clamped terminals (/H2).



Crimp-on lug with insulation sleeves (for 4-mm screws)

For clamped terminals (/H2), the following wire is recommended.

- Conductive cross-sectional area for single wire: 0.14 mm^2 to 1.5 mm^2 , stranded wire: 0.14 mm^2 to 1.0 mm^2
- Length of the stripped section of the wire: Approx. 5 mm

Take measures to prevent noise from entering the measurement circuit.

- Move the measurement circuit away from the power cable (power circuit) and ground circuit.
- It is desirable that the object being measured does not generate noise. However, if this is unavoidable, isolate the measurement circuit from the object. Also, ground the object being measured.
- Shielded wires should be used to minimize noise caused by electrostatic induction. Connect the shield to the ground terminal of the recorder as necessary (make sure you are not grounding at two points).

- To minimize noise caused by electromagnetic induction, twist the measurement circuit wires at short, equal intervals.
- Make sure to earth ground the protective ground terminal through minimum resistance.

Do not allow static electricity to be applied to the terminals.

- When wiring the terminals, remove static electricity so that static electricity is not applied.
- If static electricity or similar high-voltage transient noise is applied to the signal line, the system may break.

When using internal reference junction compensation on the thermocouple input, take measures to stabilize the temperature at the input terminal.

- Always use the terminal cover.
- Do not use thick wires which may cause large heat dissipation (cross sectional area of 0.5 mm² or less recommended).
- Make sure that the ambient temperature remains reasonably stable. Large temperature fluctuations can occur if a nearby fan turns ON or OFF.

Connecting the input wires in parallel with other devices can cause signal degradation, affecting all connected devices.

If you need to make a parallel connection, then

- Turn the burnout detection function OFF.
- Ground the instruments to the same point.
- Do not turn ON or OFF another instrument during operation. This can have adverse effects on the other instruments.
- RTDs cannot be wired in parallel.

Arrangement of the Measuring Input Terminals

A terminal cover is screwed in place on the measuring input terminal block on the rear panel. A label indicating the terminal arrangement is affixed to the cover.

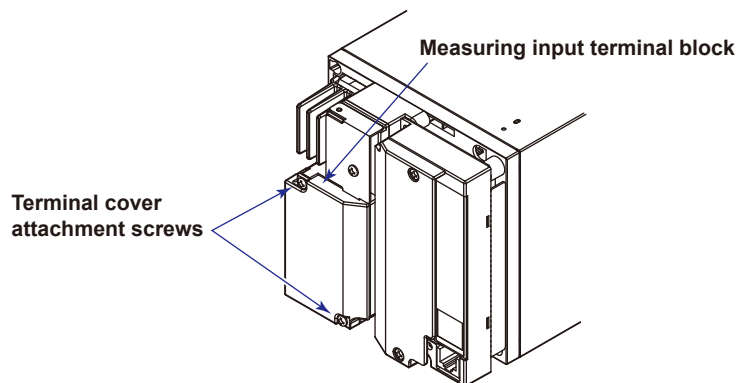

Pen Model

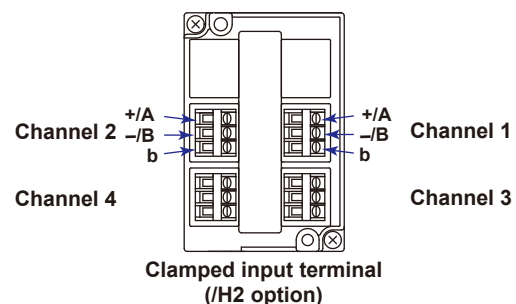
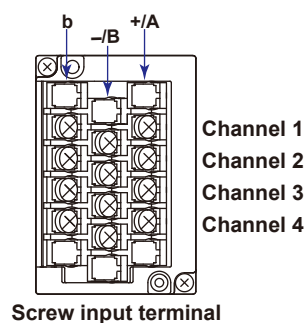

2.3 Input Signal Wiring

Dot Model

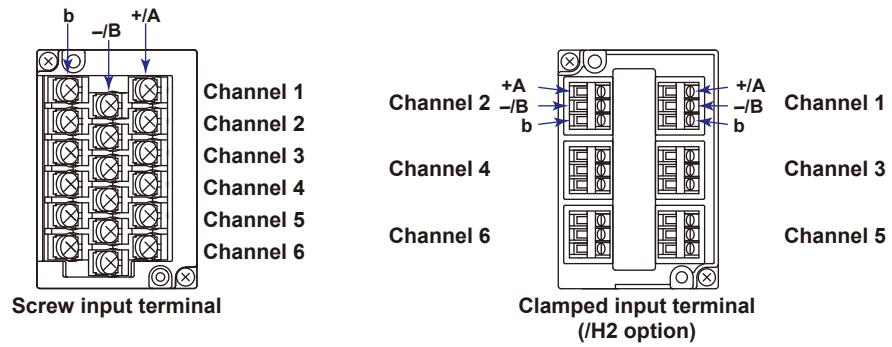

1. Turn OFF the recorder and remove the terminal cover.
2. Connect the signal wires to the terminals.

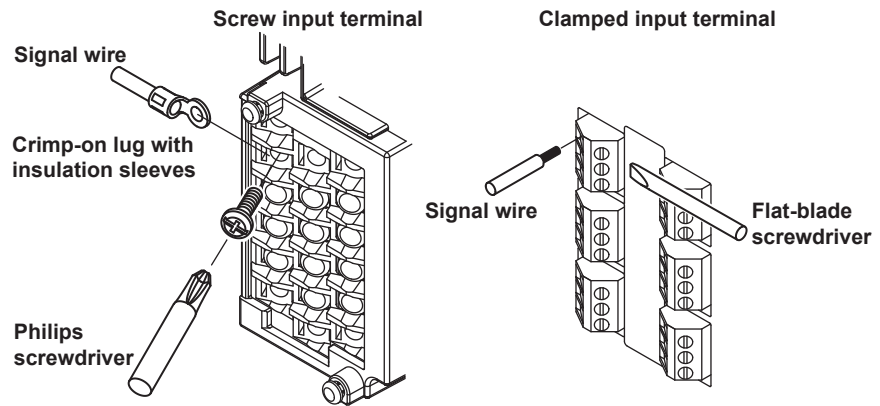

Note

Input signal wires of diameter less than or equal to 0.3 mm may not be secured firmly for clamped terminals (/H2). Fold over the conducting section of the wire, for example, to make sure that the wire is securely connected to the clamped terminal.

3. Replace the terminal cover and fasten it with screws.
The proper torque for tightening the screws is 0.6 N•m.

Measuring Input Wiring

Thermocouple input

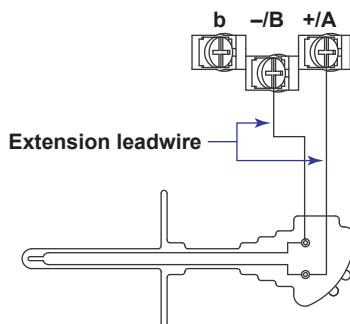

Resistance temperature detector input

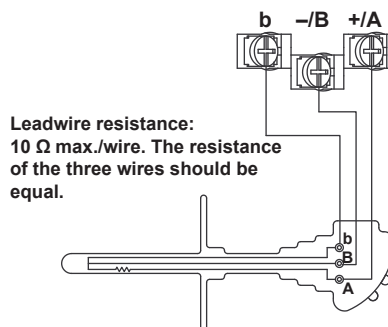

Leadwire resistance:
10 Ω max./wire. The resistance
of the three wires should be
equal.

DC voltage input, 1-5V input,
and ON/OFF input

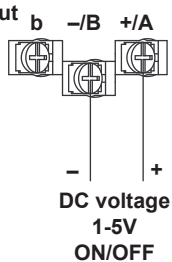

DC current input

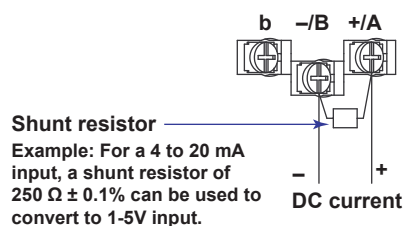

Shunt resistor
Example: For a 4 to 20 mA
input, a shunt resistor of
250 $\Omega \pm 0.1\%$ can be used to
convert to 1-5V input.

Note

RTD input terminals A and B on the dot model are isolated on each channel. Terminal b is shorted internally across all channels. However, for 3 legs isolated RTDs (/N2 option), input b is also isolated for each channel.

2.4 Optional Terminal Wiring

General Precautions to be Taken While Wiring the Input/Output Signal Wires



WARNING

- To prevent electric shock while wiring, ensure that the power supply source is turned OFF.
- If a voltage of more than 30 VAC or 60 VDC is to be applied to the output terminals, use ring-tongue crimp-on lugs with insulation sleeves on all terminals to prevent the wires from slipping out when the screws become loose. Furthermore, use double-insulated wires (dielectric strength of 3000 VAC or more) for the signal wires on which a voltage of more than 30 VAC or 60 VDC is to be applied. For all other wires, use basic insulated wires (dielectric strength of 1500 VAC). To prevent electric shock, attach the terminal cover after wiring and make sure not to touch the terminals.



Crimp-on lug with insulation sleeves (for 4-mm screws)



CAUTION

- The option terminals of this instrument are specific to this instrument. Do not connect the option terminals of the μ R1000, μ R1800 or other models, as malfunction may result.
- To prevent fire, use signal wires for recorder having a temperature rating of 70°C or more.
- If a strong tension is applied to the cable wired to the recorder, the terminals of the recorder and/or the cable can be damaged. In order to prevent tension from being applied directly on the terminals, fasten all wiring cables to the rear of the mounting panel.
- Use the following circuit voltage for the connection to the alarm/FAIL/status output terminal.
 - When the connection is to Mains Circuits (primary AC power source circuits): 150 V or less
 - When the connection is to circuits derived from Mains Circuits (secondary circuits): 250 V or less (Mains Circuits voltage is less than 300 V, and connection must be used by isolation transformer.)

Arrangement of the Optional Terminals

As shown in the figure below, the optional terminal block is located on the rear panel. The optional terminal block is provided on the recorder when an option that requires input/output is installed such as the alarm output relay (/A1, /A2, or /A3 option), FAIL/chart end output (/F1 option), remote control function (/R1 option), RS-422A/485 interface (/C3 option)*, and Ethernet (10BASE-T) interface (/C7 option)*. A terminal cover is screwed in place on the measuring input terminal block. A label indicating the terminal arrangement is affixed to the terminal block.

* For details on terminal and connector arrangement and wiring, see the μ R10000 / μ R20000 Communication Interface User's Manual (IM 04P01B01-17E).

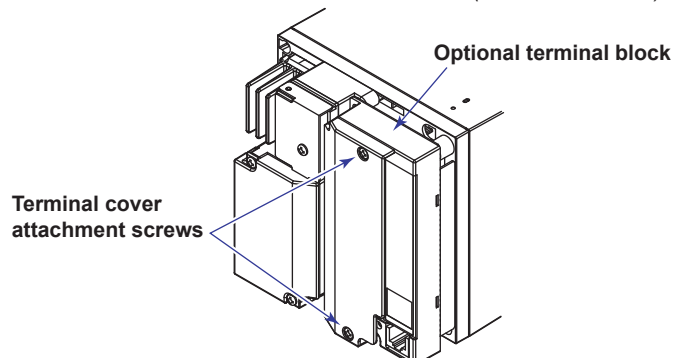

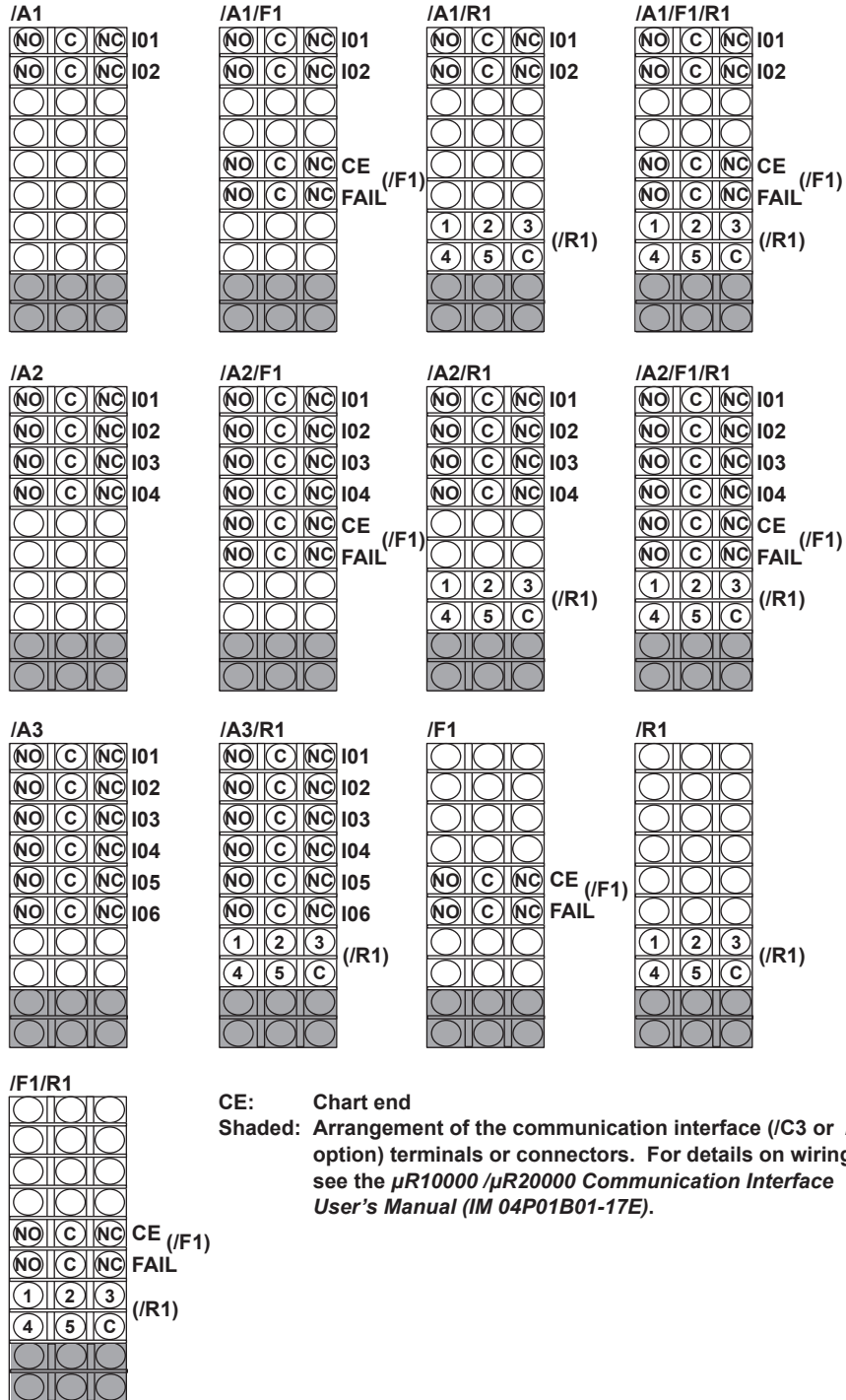

Alarm Output Relay Terminals and FAIL/Chart End Output Relay Terminals
NC (Normally Closed), C (Common), NO (Normally Opened)

Remote Control Input Terminals
1 to 5 (remote control input terminals), C (Common)

Alarm output terminals correspond to I01 to I06 in the alarm output relay settings.
Remote control input terminals 1 to 5 correspond to numbers 1 to 5 in the remote control input settings.

Wiring Procedure

1. Turn OFF the recorder and remove the terminal cover.
2. Connect the input/output signal wires to the terminals.

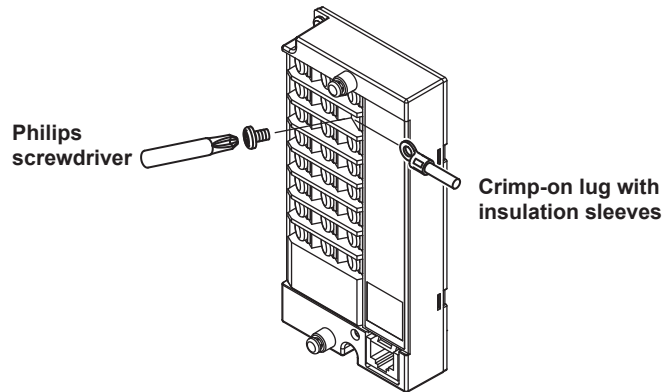

3. Replace the terminal cover and fasten it with screws.
The proper torque for tightening the screws is 0.6 N·m.

Alarm Output Relay Terminals and FAIL/Chart End Output Relay Terminals

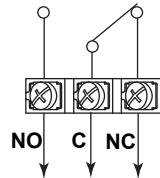

NO (Normally Opened), C (Common), NC (Normally Closed)

• Relay Contact Output Specifications

- Output type: Relay
- Contact rating: 250 VAC (50/60 Hz)/3 A, 250 VDC/0.1 A (resistive load)
- Dielectric strength: 1500 VAC at 50/60 Hz for one minute (between output terminals and the ground terminal)

Remote Control Input Terminals

Relay contact input (voltage-free contact)

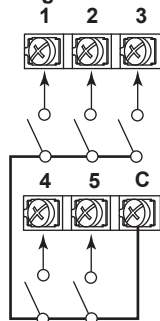

Transistor input (open collector)

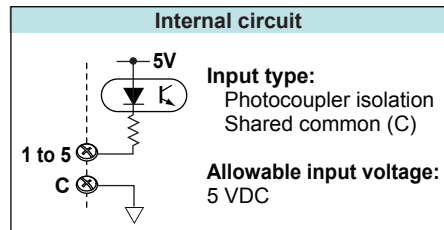
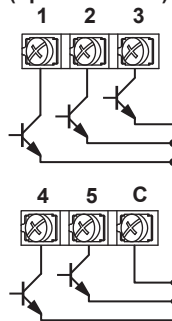

C: Negative side of the power supply

1 to 5 (Remote control input terminals), C (Common)

• Relay Contact Input/Transistor Input Specifications

- Input signal:
 - Voltage-free contact: Contact closed at 200 Ω or less and contact open at 100 k Ω or greater
 - Open collector: 0.5 V or less (30 mADC) when turned ON, leakage current of 0.25 mA or less when turned OFF
- Dielectric strength: 500 VDC for one minute between input terminals and the ground terminal

Note

To reduce noise, use a shielded cable for the wiring of the remote control input terminals. Connect the shield to the ground terminal of the recorder.

2.5 Power Supply Wiring

Precautions to Be Taken While Wiring the Power Supply

Make sure to follow the warnings below when wiring the power supply. To prevent electric shock and damage to the recorder, observe the following warnings.



WARNING

Panel Mount Type

- To prevent electric shock when wiring, ensure the main power supply is turned OFF.
- To prevent the possibility of fire, use 600 V PVC insulated wire (AWG 20 to 16) or an equivalent wire for power wiring.
- Make sure to earth ground the protective earth terminal through minimum resistance before you turn on the power.
- Use crimp-on lugs (designed for 4 mm screws) for power and ground wiring termination.
- To prevent electric shock, make sure to close the transparent cover for the power supply wires.
- For safety, provide a double-pole switch in an easily operable location near the recorder to disconnect the recorder from the main power supply. Put an indication on this switch as the breaker on the power supply line for the recorder and indications of ON and OFF.

Switch specifications

Rated power current: 1 A or more (other than /P1), 3 A or more (/P1 option)
 Rated rush current: 60 A or more (other than /P1), 70 A or more (/P1 option)
 Complies with IEC 60947-1, 3.

- Connect a fuse in the power supply line. Use a fuse approved by CSA (for the use in North America) or VDE (for the use in Europe).
 2 A to 15 A (other than /P1), 4 A to 15 A (/P1 option)
- Do not add a switch or fuse to the ground line.

Portable Type (/H5x Option)

- Ensure that the source voltage matches the rated power supply voltage of the instrument before connecting the power cord.
- Connect the power cord after checking that the power switch of the portable type is turned OFF.
- To prevent electric shock or fire, be sure to use the power cord for the portable type supplied by YOKOGAWA.
- Make sure to connect protective earth grounding to prevent electric shock. Connect the power cord of the portable type to a three-prong power outlet equipped with a protective earth terminal.
- Do not use an extension cord that does not have a protective grounding wire. The protective features of the instrument will be rendered ineffective.

Use a power supply that meets the following conditions:

Item	Power Supply Specifications	
	(Options Other Than /P1)	(/P1 Option)
Rated supply voltage	100 to 240 VAC	24V DC/AC
Allowable power supply voltage range	90 to 264 VAC	21.6 V to 26.4 VDC/AC
Rated power supply frequency	50/60 Hz	50/60 Hz (for AC)
Allowable power supply frequency range	50/60 Hz \pm 2%	50/60 Hz \pm 2% (for AC)
Maximum power consumption	40 VA	25 VA (for DC) or 35 VA (for AC)

Note

Do not use a supply voltage in the range 132 to 180 VAC, as this may have adverse effects on the measurement accuracy.

Wiring Procedure

Panel Mount Type

The power supply terminals and protective ground terminals are located on the rear panel.

1. Turn OFF the power switch on the recorder and open the power terminal cover.

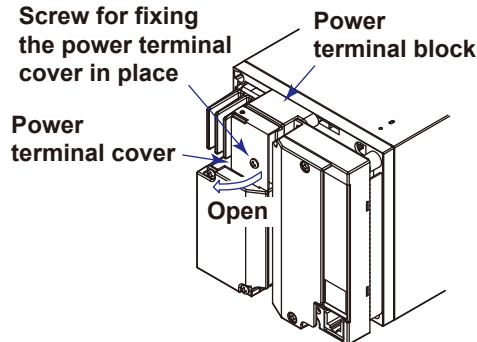

2. Wire the power cord and the protective ground cord to the power supply terminals. Use ring-tongue crimp-on lugs (designed for 4 mm screws).

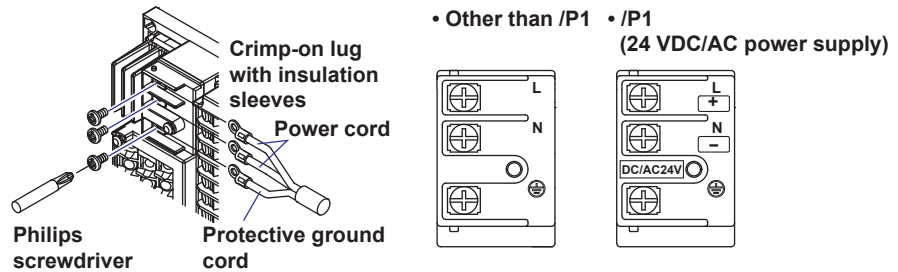

3. Close the power supply terminal cover and secure it with the screw. The proper torque for tightening the screws is 0.6 N•m.

Portable Type (/H5x Option)

1. Check that the power switch to the recorder is turned OFF.
2. Connect the plug on the accessory power cord to the power supply connector on the rear panel.

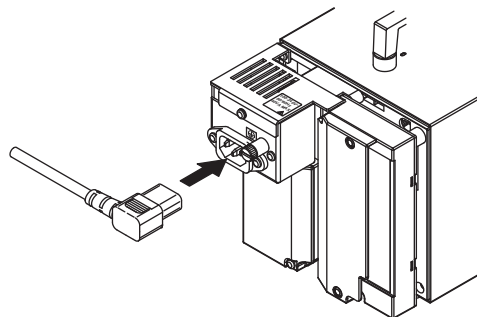

3. Ensure that the power outlet to be used meets the conditions on the previous page and that the voltage of the power supply is within the maximum voltage rating of the power cord, then connect the other end of the power cord to the power supply outlet.
The AC outlet must be of a three-prong type with a protective earth ground terminal.

2.6 Turning ON/OFF the Power Switch



CAUTION

Check the following points before turning ON the power switch.

- The power cord/wires are connected correctly to the recorder.
- The recorder is connected to the correct power supply (see section 2.5).

The power switch is located inside the door at the lower right.

The power switch is a push button. Press once to turn it ON and press again to turn it OFF.

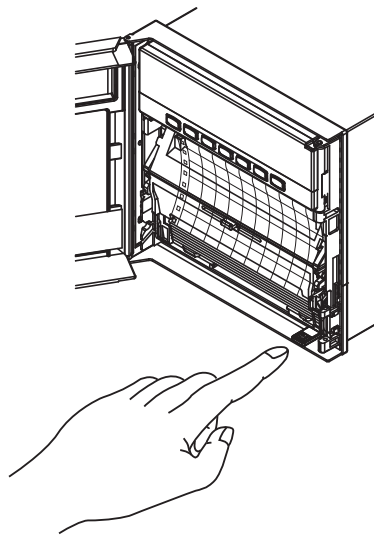

When the power switch is turned ON, a self-diagnosis program runs for a few seconds, and the recorder is ready for operation.

Note

- If the input wires are connected in parallel with other devices, do not turn ON/OFF the power switch of the recorder or another device during operation. This can have adverse effects on the measured values.
- If nothing is displayed when the power switch is turned ON, turn OFF the power switch and check the points listed above one more time. After checking the points, turn ON the power switch again. If the unit still does not work, it is probably malfunctioning. Contact your nearest YOKOGAWA dealer for repairs.
- If an error message is displayed on the screen, take measures according to the description in chapter 10, "Troubleshooting."
- Turn ON the power switch, let the recorder warm up for at least 30 minutes, and then start the measurements.
- The instrument's power switch may stop working after long periods of use in high-temperature low-humidity environments.

Checking the Date/Time

The date/time is shown on the display when the **DISP** key is pressed several times. To correct the date/time, see the reference indicated below.

<Related Topics> Setting the date/time: See section 5.5

Blank

3.1 Names of Parts

Front

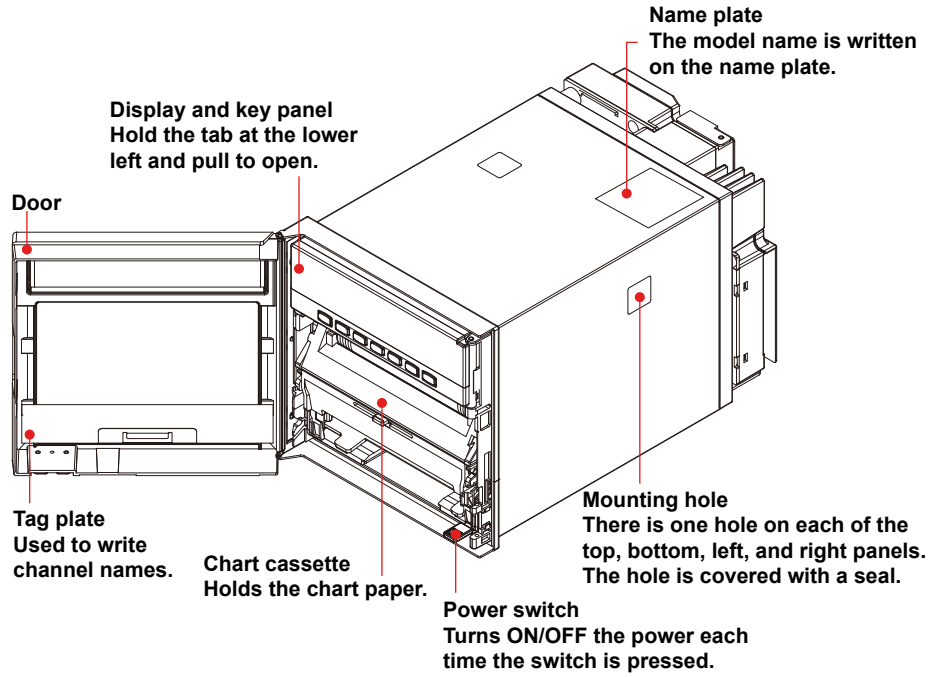

Pen model

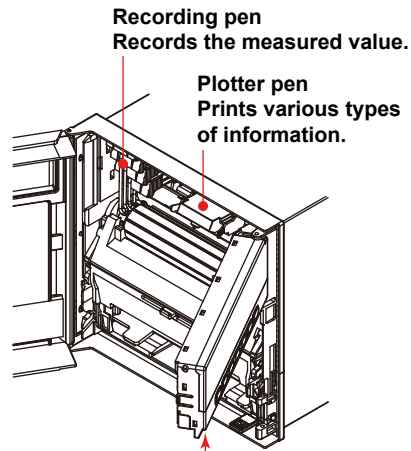

Dot model

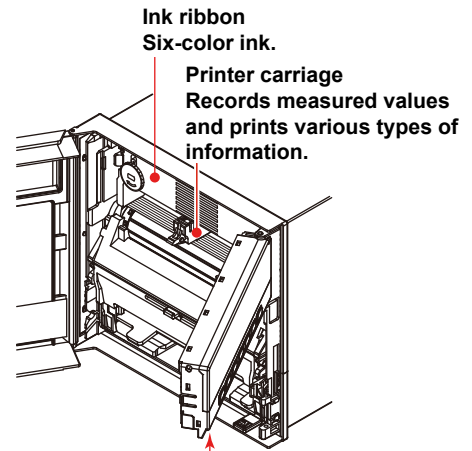

Display and key panel (see the next page)
There is an internal light on the bottom section of the display and key panel. It lights up the recording area of the chart paper.

Display and Key Panel

Status display

Displays the following information.

- RECORD** Illuminates while recording measured values.
- KEY LOCK** Illuminates when key lock is enabled.
- MATH** Illuminates when computation on the computation function (/M1 option) is in progress.
- CHART END** Illuminates when the chart paper is out (/F1 option).
- ALARM 1 to 6** Illuminates when an alarm is occurring on channels 1 to 6.

Main display

Displays the measured values. Also, displays the setup screen when setting functions.

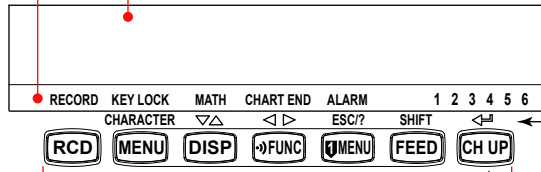

Seven keys are available.

For all keys except RCD, functions marked above the keys are enabled when setting functions or when the FUNC key or the DISP MENU key is pressed.

<While setting functions, when the FUNC key/DISP MENU key is pressed>

CHARACTER Key: Changes the character type when entering a character. Press this key while holding down the SHIFT key to switch the character type in reverse order.

UP/DOWN Key: Switches the setup item or the value. Press this key while holding down the SHIFT key to switch the setup item or the value in reverse order.

LEFT/RIGHT Key: Moves the cursor to the right when entering a value or character. Press this key while holding down the SHIFT key to move the cursor to the left.

ESC Key: Cancels the operation. When pressed with the SHIFT key, the display of the comment on the setting turns ON/OFF.

SHIFT Key: Used with the ∇△ key, <▷ key, or the CHARACTER key.

ENTER Key: Confirms the setup item or value.

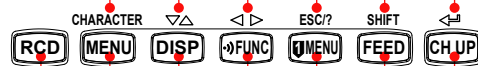

<During normal operation>

CH UP key
Switches the displayed channel.
(when manual switching is specified)

FEED key
Feeds the chart paper.

DISP MENU key
Hold this key down for 3 seconds to switch to the data display setup screen. Hold this key down for 3 seconds also to exit from the data display setup screen.

FUNC key
Used when executing manual printout, message printout, etc.

DISP key
Switches the screen in the main display.

MENU key
Hold this key down for 3 seconds to enter Setting mode. Hold this key down for 3 seconds also to exit from Setting mode.

RCD key
Starts/stops recording.

Note

This manual denotes the operation of pressing a key while holding down the **SHIFT** key as **SHIFT** + the other key (for example: **SHIFT** + <▷ key>).

Rear Panel

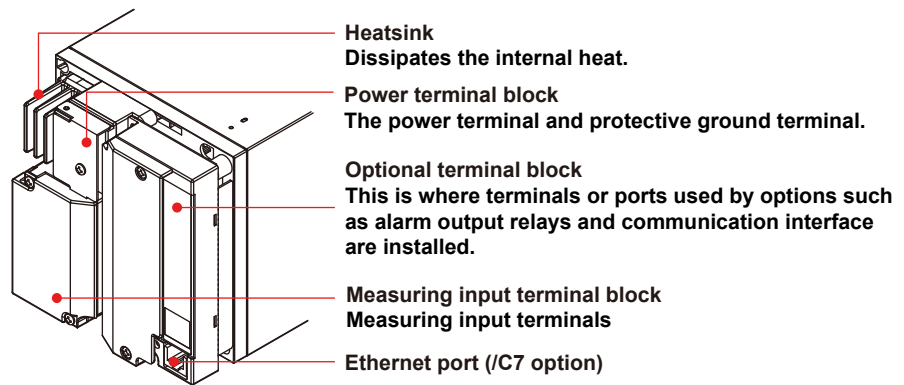

Portable Type (/H5x Option)

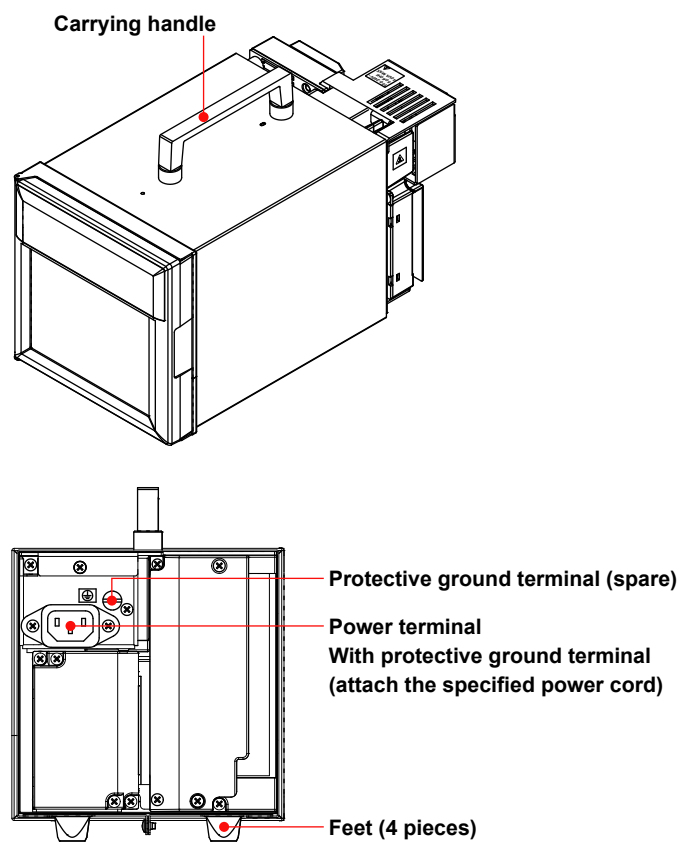

3.2 Installing or Replacing the Chart Paper

CAUTION

- Do not install or remove the chart cassette with the chart paper guide open. This may damage the stopper.
- Continuing to record or print without the chart paper on the dot model can cause damage to the chart cassette platen (the cylindrical section that holds the paper during the recording operation). Be sure to replace the chart paper ahead of time.
- When attaching the chart cassette, push it in until you hear the left and right stoppers click into place. Recordings will be inaccurate if the chart cassette is not fixed in place with stoppers.

Loading the Chart Paper

1. Open the door.

If recording is in progress, press the **RCD** key to stop the recording.

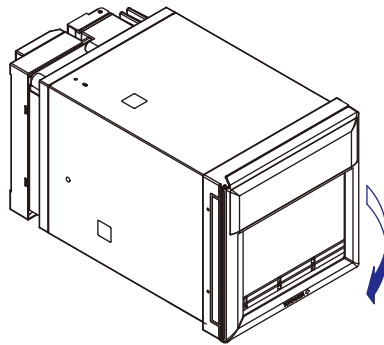

2. Remove the chart cassette.

Gently pressing the left and right stoppers inward. The bottom section of the chart cassette comes out. Gently lift the chart cassette and pull it out from the recorder case.

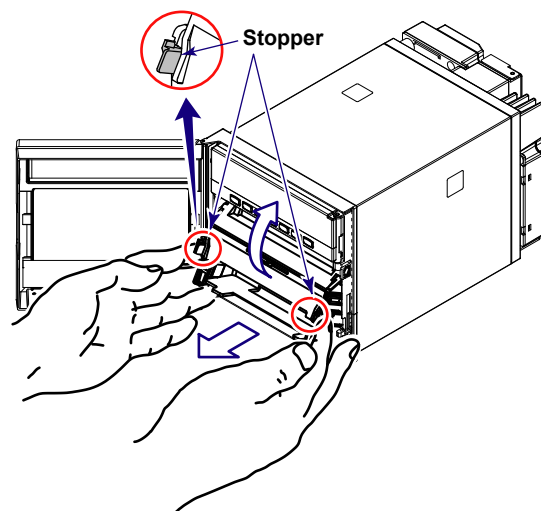

- Open the chart holder and the chart paper guide.

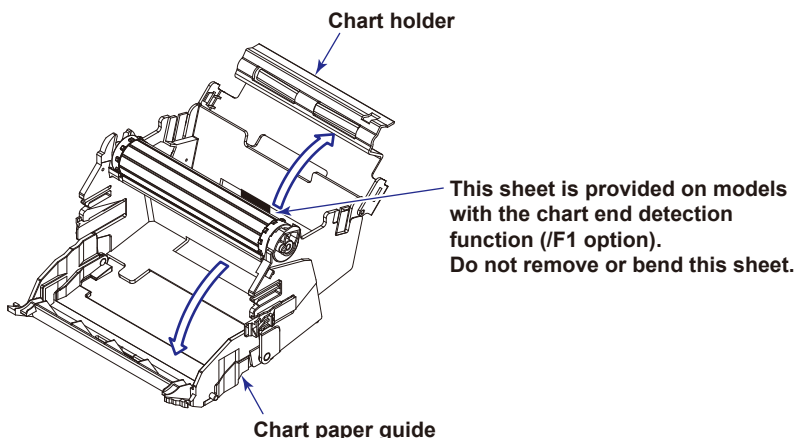

- Load the chart paper. Riffle the chart thoroughly before loading. Make sure that the sprocket teeth of the chart drives are properly engaged in the chart paper perforations. Make sure not to load the chart paper backwards.

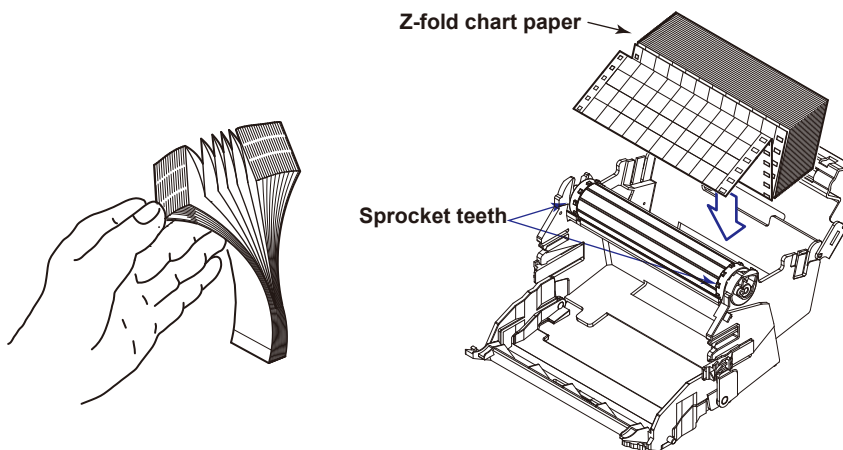

- Close the chart holder and close the chart paper guide.

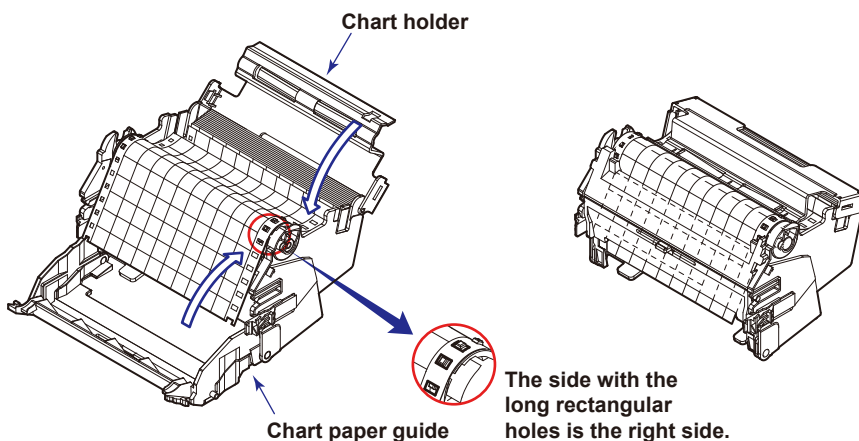

3.2 Installing or Replacing the Chart Paper

6. Replace the chart cassette back into the recorder case.
Align the left and right projections of the sprocket section with the guide grooves of the recorder and press the entire chart cassette into the recorder case. Push in the chart cassette until it is fixed in place with stoppers.

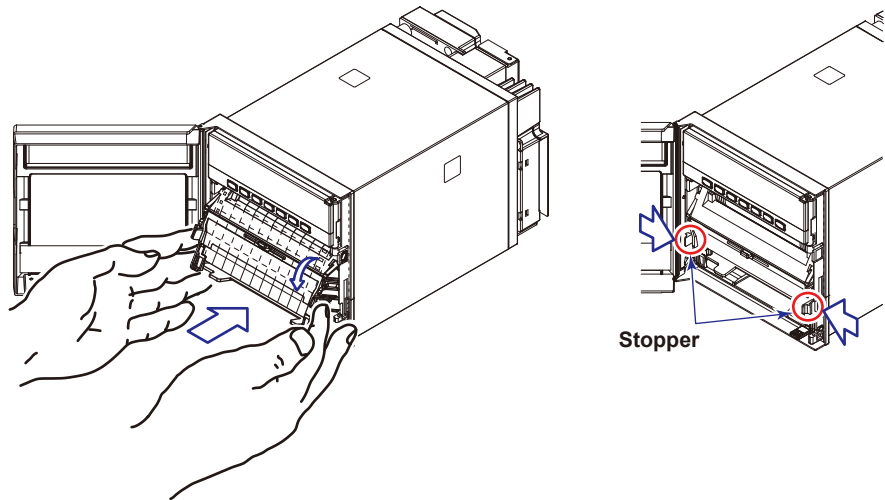

Feeding the Chart Paper

7. Press the **FEED** key to assure that the chart moves two or more folds smoothly into the chart receiver.
If it moves unsteadily, do the installing procedure again.

3.3 Installing/Replacing Felt Pens or Plotter Pen (Pen Model)

CAUTION

- Remove the chart cassette before replacing the pens. Pressing the pen tip against the chart cassette will cause the tip to deform.
- Do not press or pinch the felt tip to prevent deformation.
- Do not move the penholder left or right by force to protect the driving mechanism.
- Make sure to remove the pen cap before installation.
- Use pen caps of the same ink color. If a pen cap of a different ink color is used on the pen, the remaining ink in the cap may be absorbed through the pen tip, and the ink may change its color.
- When installing or replacing a pen, be careful not to let the ink come in contact with the eyes, mouth, or skin. If the ink enters the eyes or mouth, immediately wash with water. If the ink makes contact with your skin, immediately wash with soap and water. If you notice any abnormal symptoms, immediately consult a doctor.

Replacing Felt Pens

1. Open the door.
If recording is in progress, press the **RCD** key to stop the recording.
2. Open the display and key panel section.
You can open the display and key panel section by holding the tab at the lower left and pulling it toward you.
3. Hold the felt pen cartridge and pull it out from the pen holder.
If the pen (pen holder) is at a position that is not easily accessible, see “When the Pen (Pen Holder) Is at a Position That Is Not Easily Accessible” on the next page.
4. Remove the cap from the new felt pen and insert the pen firmly into the pen holder.

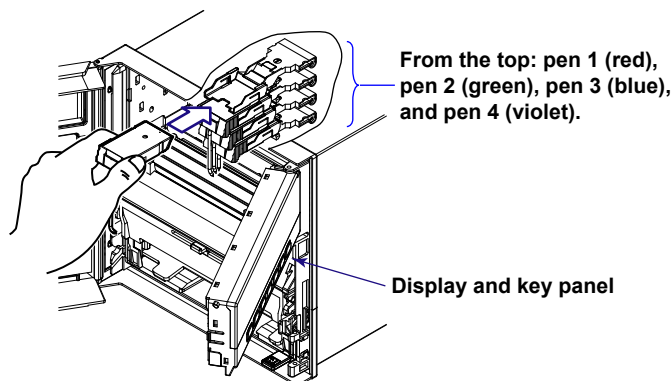

3.3 Installing/Replacing Felt Pens or Plotter Pen (Pen Model)

When the Pen (Pen Holder) Is at a Position That Is Not Easily Accessible

If the pen (pen holder) is at a position that is not easily accessible, carry out the procedure below to move it near the center position.

1. Turn ON the power switch and press the **⏪FUNC** key.
2. Press the **◀▶ (DISP)** key several times to display the **Pen exchange** screen.

Func=Pen exchange

3. Press the **↵ (CH UP)** key.
The pen (pen holder) moves near the center position, and the **Pen exchange = End** appears.

Note

When the pen moves, a line is drawn on the chart paper.

4. Replace the pen.
5. Press the **↵ (CH UP)** key.
The screen returns to the data display screen.

Replacing the Plotter Pen

1. Open the door.
If recording is in progress, press the **RCD** key to stop the recording.
2. Open the display and key panel section.
3. Hold the plotter pen cartridge and pull it out from the pen holder.
4. Remove the cap from the new plotter pen and insert the pen firmly into the pen holder.

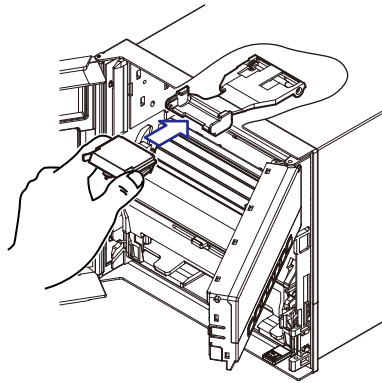

3.4 Installing/Replacing the Ribbon Cassette (Dot Model)

CAUTION

- Improper cassette insertion may cause the color to change or damage the ribbon.
- Do not apply upward force to the printer carriage. If you do, the carriage position may be offset, and the recorder may not print correctly.
- When installing or replacing a ribbon cassette, be careful not to let the ink come in contact with the eyes, mouth, or skin. If the ink enters the eyes or mouth, immediately wash with water. If the ink makes contact with your skin, immediately wash with soap and water. If you notice any abnormal symptoms, immediately consult a doctor.

1. Open the door.
If recording is in progress, press the **RCD** key to stop the recording.
2. Press the **FUNC** key.
3. Press the **DISP** key several times to display **R. exchange**.

Func=R. exchange

4. Press the **CH UP** key.
The printer carriage moves near the center position, and **R. exchange = End** is displayed.
5. Open the display and key panel section.
You can open the display and key panel section by holding the tab at the lower left and pulling it toward you.

Note

- Moving of the printer carriage using keys is a function available on version 1.11 or later.
- If the recorder is OFF, pinch the printer carriage and move it near the center position.

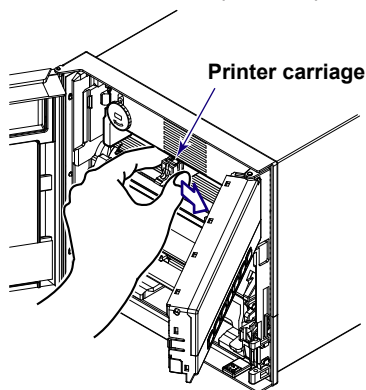

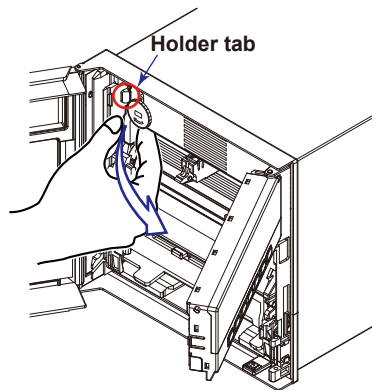

3.4 Installing/Replacing the Ribbon Cassette (Dot Model)

6. Remove the ribbon cassette.
Pull the left-hand part of the ribbon cassette so that the cassette holder tab disengages, and pull the ribbon cassette out from the recorder case.

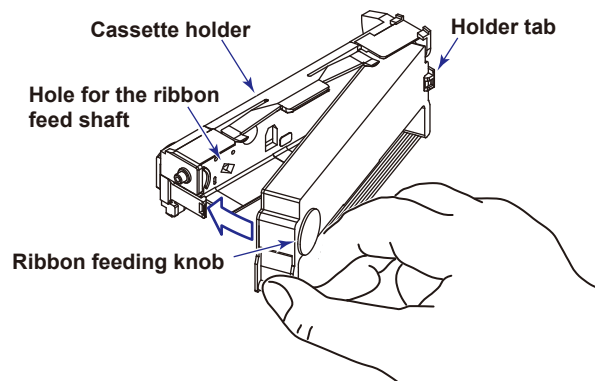

7. Take up any slack in the ribbon before installing the new ribbon cassette.
First, insert the right-hand part and then the left-hand part into the cassette holder. Check that the cassette is properly engaged with the cassette holder tab. If inserting the ribbon cassette is difficult, turn the ribbon feeding knob in the direction of the arrow to align the ribbon feeding shaft of the cassette with the ribbon feeding shaft hole of the holder.



8. Return the display and key panel section to its original position, and press the  (CH UP) key.
The screen returns to the data display screen.

3.5 Starting/Stopping the Recording

This section describes the procedures for starting/stopping the chart feed and checking the recorded result.

Procedure

Starting the Recording

Press the **RCD** key to start the chart feed.
The status display shows the word "RECORD."

Note

For models with the FAIL/chart end detection and output function (/F1 option), the chart feed will not start even when pressing the RCD key if the chart paper is empty or almost out. Insert new chart paper before pressing the RCD key.

Stopping the Recording

While recording is in progress, press the **RCD** key to stop the chart feed.
The word "RECORD" on the status display clears.

Feeding the Chart Paper Manually

The chart paper is fed while the **FEED** key is held down.

Viewing the Recorded Results

Pull the front cover tab of the chart cassette to open the front cover. The recorded chart paper can be pulled out for viewing.

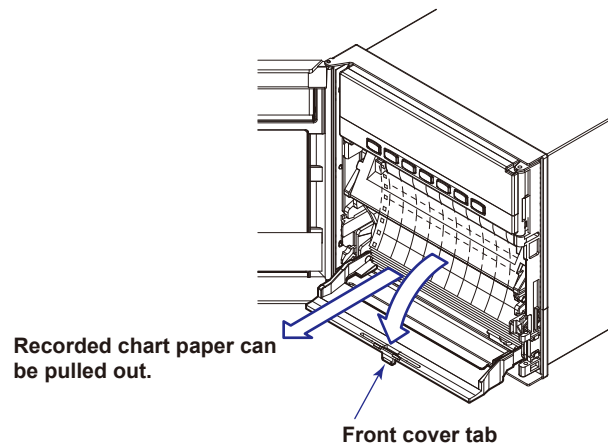

<Related Topics> Changing the chart speed: Section 5.4

3.6 Switching the Display Screen

This section describes the procedure for switching the display screen.
To change the displayed content, see chapter 8.

Procedure

Switching the Display Screen

The display screen switches each time the **DISP** key is pressed.
Screen 01 through 15 are switched in order. Screens that are set to "Skip" are skipped.

Channel Auto Switching

On screens that show the measured values and computed values, the displayed channel is automatically switched in ascending order. The switching interval can be set to 1 s, 2 s, 3 s, 4 s, or 5 s.

Measurement channels set to Skip and computation channels set to OFF are not displayed.

Switching the Displayed Channel Using Keys

If Manual switching is specified, the channel switches each time the **CH UP** key is pressed in ascending order. All channels are displayed in order.

Note

The operation is different between auto channel switching and manual switching using keys on the 2-channel digital display.

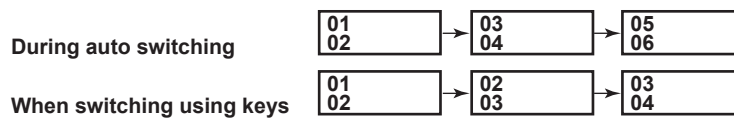

3.7 Printing Measured Values (Manual Printout)

Prints the measured values of all channels and the computed results when computation mode is on.

Procedure

Starting the Manual Printout

1. Press the  key.
2. Press the  key to select **Print out** and then press the  key.

```
Func=Print out
```

3. Press the  key with **ManualStart** shown on the screen. Manual printout starts. The screen returns to the data display screen.

```
Print=ManualStart
```





For a printout example, see “Printout” on page 1-16.

Note



- When manual printout is executed, trend recording is suspended. However, the recorder continues the measurement and alarm detection (in the background).
- When manual printout is complete, trend recording resumes.
- If an alarm occurs during the manual printout, the alarm is printed after the trend recording resumes.

Aborting the Manual Printout

The following procedure is for aborting the manual printout that is in progress.

1. Press the  key.
2. Press the  key to select **Print out** and then press the  key.
3. Press the  key with **Manual Stop** shown on the screen. Manual printout stops. The screen returns to the data display screen.

```
Print=Manual Stop
```

* When the  key or  key is pressed while holding down the **SHIFT** key, the operation is reversed as when the respective key is pressed by itself.

3.8 Printing the Recorder Settings

This section explains the procedure for printing the recorder settings. There are two sets of settings that can be printed: List and Setup.

List: Prints the settings of Setting mode (input range for each channel, etc.)

Setup: Prints the settings of Basic Setting mode

Note

- The printout takes several minutes to tens of minutes to complete.
- When this printout is executed, trend recording is suspended. However, the recorder continues the measurement and alarm detection (in the background).
- When the printout is complete, trend recording resumes.
- If an alarm occurs during the printout, the alarm is printed after the trend recording resumes.

Procedure

Starting the List Printout

1. Press the **FUNC** key.
2. Press the **▽△** key to select **Print out** and then press the **↵** key.
3. Press the **▽△** key to display **List Start** and then press the **↵** key.
The List printout starts. The screen returns to the data display screen.

```
Print=List Start
```

Aborting the List Printout

1. Press the **FUNC** key.
2. Press the **▽△** key to select **Print out** and then press the **↵** key.
3. Press the **▽△** key to display **List Stop** and then press the **↵** key.
The List printout stops. The screen returns to the data display screen.

```
Print=List Stop
```

Starting the Setup Printout

1. Press the **FUNC** key.
2. Press the **▽△** key to select **Print out** and then press the **↵** key.
3. Press the **▽△** key to display **Setup Start** and then press the **↵** key.
The Setup printout starts. The screen returns to the data display screen.

```
Print=Setup Start
```

Aborting the Setup Printout

1. Press the **FUNC** key.
2. Press the **▽△** key to select **Print out** and then press the **↵** key.
3. Press the **▽△** key to display **Setup Stop** and then press the **↵** key.
The Setup printout stops. The screen returns to the data display screen.

```
Print=Setup Stop
```

* When the **◀▶** key or **▽△** key is pressed while holding down the **SHIFT** key, the operation is reversed as when the respective key is pressed by itself.

3.9 Clearing the Alarm Printout Buffer

Alarm information waiting to be printed is temporarily stored in the buffer memory. This operation clears all of the alarm information in the buffer. This function can be used to prevent unneeded alarm printouts from being executed.

Procedure

1. Press the **FUNC** key.
2. Press the **▽△** key to select **Buffer clear** and then press the **↵** key.

```
Func=Buffer clear
```

3. Press the **▽△** key to select **Alarm** and then press the **↵** key.
The data in the alarm printout buffer is cleared. The screen returns to the data display screen.

```
Buf.clear=Alarm
```

* When the **◀▶** key or **▽△** key is pressed while holding down the **SHIFT** key, the operation is reversed as when the respective key is pressed by itself.

3.10 Printing Messages

This section explains the procedure for printing the preset character strings. For the procedure of setting the character strings, see section 6.8.

Note

- Messages can be printed only during trend recording. However, regardless of whether trend recording is ON or OFF, messages waiting to be printed are temporarily stored in the buffer memory.
- Message printouts are not performed when the chart speed is greater than or equal to 1600 mm/h and 101 mm/h on the pen model and dot model, respectively.

Procedure

Printing a Message

1. Press the **↔FUNC** key.
2. Press the **▽△** key to select **Message** and then press the **↵** key.

```
Func=Message
```

3. Press the **▽△** key to select message number and then press the **↵** key.
The message printout starts. The screen returns to the data display screen.

```
Message=Message1
```

← Displays the preset me:

Clearing the Message Printout Buffer

Messages waiting to be printed are temporarily stored in the buffer memory. This operation clears the messages in the buffer.

1. Press the **↔FUNC** key.
2. Press the **▽△** key to select **Buffer clear** and then press the **↵** key.
3. Press the **▽△** key to select **Message** and then press the **↵** key.
The messages in the printout buffer are cleared. The screen returns to the data display screen.

```
Buf.clear=Message
```

* When the **◀▶** key or **▽△** key is pressed while holding down the **SHIFT** key, the operation is reversed as when the respective key is pressed by itself.

3.11 Resetting the Report Data of the Periodic Printout



This operation resets the past report data when the recorder is configured to print the report data (the average, the minimum, the maximum, or the sum) of the measured values in periodic printout.

Procedure



Resetting the Report Data

1. Press the  key.
2. Press the  key to select **Periodic** and then press the  key.

```
Func=Periodic
```

3. Press the  key to select **Reset** and then press the  key.
The report data is reset, and the calculation of the report data starts again from that point. The screen returns to the data display screen.

```
Log data=Reset
```

* When the  key or  key is pressed while holding down the **SHIFT** key, the operation is reversed as when the respective key is pressed by itself.

3.12 Releasing the Alarm Output (Alarm ACK Operation)

This operation releases the alarm indication or relay output (/A1, /A2, or /A3 option) when the alarm indication or output relay is set to hold operation.

Procedure

Releasing the Alarm Output

1. Press the **↔FUNC** key.
2. Press the **↵** key with **Alarm ACK** shown on the screen.
The alarm indication or relay output is released. The screen returns to the data display screen.

Func=Alarm ACK

Explanation

Alarm Output Relay Operation

- When the alarm is released
The alarm output is released when the alarm ACK operation is carried out.
- When an alarm is occurring
The alarm output is held even after the alarm ACK operation. If the alarm ACK operation is carried out again after the alarm is released, the alarm output is released.

Indication (Status Display)

Blinks when an alarm occurs.

- When the alarm is released
The alarm indication turns OFF when the alarm ACK operation is carried out.
- When an alarm is occurring
The alarm indication turns ON after the alarm ACK operation. The alarm indication turns OFF when the alarm is released.

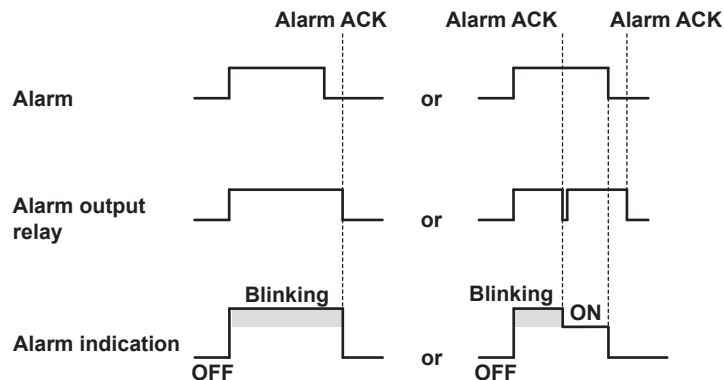

3.13 Activating/Releasing the Key Lock

When the recorder is configured to use the key lock function, this operation activates or releases the key lock.

Note

Key lock does not apply to the **DISP** and **CH UP** keys.

Procedure

Activating the Key Lock

1. Press the **FUNC** key.
2. Press the **▽△** key to select **Keylock** and then press the **↵** key.
The key lock is activated. The screen returns to the data display screen.

Func=Keylock

Releasing the Key Lock

Note

A password is required to release the key lock.

1. Press the **FUNC** key.
2. Press the **▽△** key to select **Keylock** and then press the **↵** key.
3. Enter the password for releasing the key lock. The password values are shown with asterisks.
Press the **▽△** key to increment the value.
Press the **SHIFT + ▽△** key to decrement the value.
Press the **◀▶** key to move the cursor to the right.
Press **SHIFT + ◀▶** key to move the cursor to the left.

Password=

4. Press the **↵** key.
The key lock is released. The screen returns to the data display screen.

<Related Topics> Changing the password: Section 7.10

* When the **◀▶** key or **▽△** key is pressed while holding down the **SHIFT** key, the operation is reversed as when the respective key is pressed by itself.

Blank

4.1 Run Modes

The recorder has three run modes.

Operation Mode

This mode is used for normal recording operation. The recorder enters this mode when the power is turned ON. The operations that can be carried out in this mode are described in chapter 3. The details on the data display setup screen are explained in chapter 8.

Setting Mode

This mode is used to set the input range, alarms, chart speed, and other parameters. These settings can be changed while recording is in progress. However, the input range of measurement channels and the computing equation, unit, constant, and TLOG setting of computation channels cannot be changed while computation (/M1 option) is in progress. The operations that can be carried out in this mode are described in chapter 5 and 6.

Basic Setting Mode

This mode is used to set the basic specifications of the recorder such as the thermocouple burnout detection function and the alarm output relay operation. This mode cannot be entered while the recorder is recording or while computation is in progress on the computation function (/M1 option). Measurement, recording, and alarm detection cannot be carried out in this mode. The operations that can be carried out in this mode are described in chapter 7.

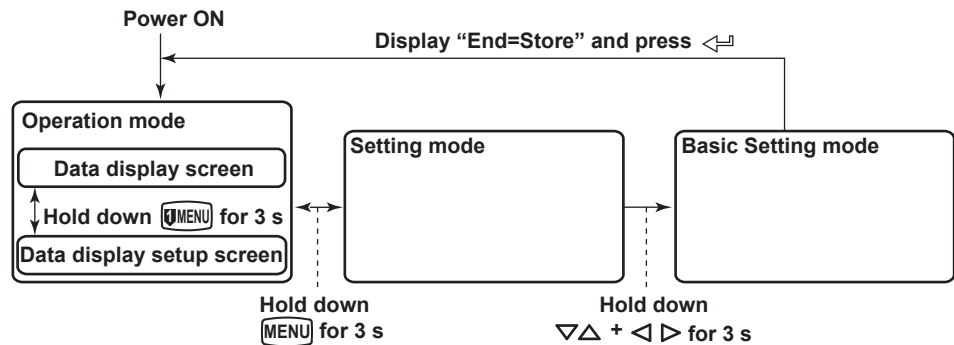

4.2 Key Operations

This section describes basic operations on the panel keys to change various settings. Functions are set in Setting mode or Basic Setting mode.

Entering Setting Mode

Hold down the **MENU** key for 3 seconds.

The Setting mode display appears. The top and bottom lines are the setup item and comment, respectively.

The section that is blinking in the setup item that you change. In this manual, the section that you change appears shaded.

Setup item → Set=**Range** ← The item to be controlled blinks.
Comment → Input range and

The panel keys are set to the functions marked above the keys.

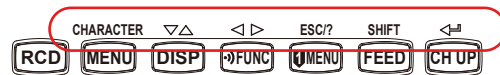

Exiting from Setting Mode (Returning to Operation Mode)

Hold down the **MENU** key for 3 seconds.

The screen returns to operation mode.

Entering Basic Setting Mode

Basic Setting mode is entered from Setting mode.

Hold down the **MENU** key for 3 seconds to enter Setting mode. Next, hold down both the **∇Δ (DISP)** key and the **<|> (FUNC)** key for 3 seconds.

The Basic Setting mode display appears. The top and bottom lines are the setup item and comment, respectively.

The section that is blinking in the setup item that you change. In this manual, the section that you change appears shaded.

Setup item → Basic=**Alarm** ← The item to be controlled blinks.
Comment → Auxiliary alarm

Exiting from Basic Setting Mode (Returning to Operation Mode)

This operation is used to return to Operation mode after changing the settings in Basic Setting mode.

Press the **ESC** key several times to return to the **Basic=** screen.

Press the **∇Δ** key or **SHIFT + ∇Δ** key to select **End** and then press the **<|≡** key. The setup save screen appears.

```
Basic=End  
Save Settings
```

Press the **∇Δ** key to select **Store** and then press the **<|≡** key. The setting is applied, and the screen returns to Operation mode. If you select **Abort** and press the **<|≡** key, the setting is discarded, and the screen returns to Operation mode.

```
End=Store  
Save settings and
```

Changing the Settings

Note

The comment line shows useful information such as a description of the setup item and the range of selectable values. Read the comment and change the items as necessary.

The selected item change each time you press the $\nabla\Delta$ key. The selected item changes in reverse order if you press the $\nabla\Delta$ key while holding down the **SHIFT** key.

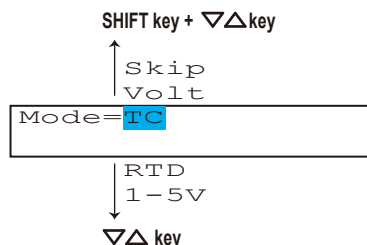

This manual denotes the operation of pressing a key while holding down the **SHIFT** key as **SHIFT** + the other key (for example: **SHIFT** + $\nabla\Delta$ key).

After you make a selection, press the \leftarrow key. The next screen appears.

When the **Setting complete** screen appears, the changed item is applied.

```
01-01 Channel
Setting complete
```

Using the ESC Key

If you press the **ESC** (**MENU**) key, the operation is cancelled, and the display returns to a higher level menu. In other words, if you do not show the Setting Complete screen, the changes you made up to that point are discarded.

Press the **ESC** (**MENU**) key while holding down the **SHIFT** (**FEED**) key to show or hide the comment that is displayed at the bottom half of the screen.

Entering Values

Use the $\leftarrow\rightarrow$ key or **SHIFT** + $\leftarrow\rightarrow$ key to move the cursor. Use the $\nabla\Delta$ key or **SHIFT** + $\nabla\Delta$ key to change a digit value. You repeat these steps to enter the value.

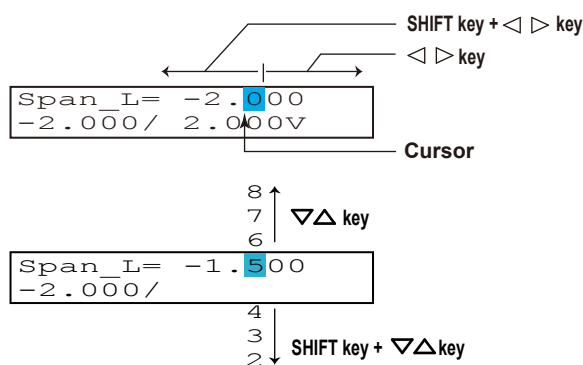

When you press the \leftarrow key, the change is applied and the next screen is displayed.

Entering Characters

Use the $\triangleleft \triangleright$ key or **SHIFT** + $\triangleleft \triangleright$ key to move the cursor.

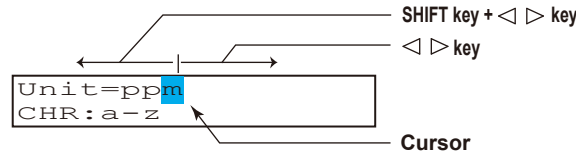

Use the **CHARACTER** key or **SHIFT** + **CHARACTER** key to select the character type. Use the $\nabla \Delta$ key or **SHIFT** + $\nabla \Delta$ key to select a character. You repeat these steps to set the character string.

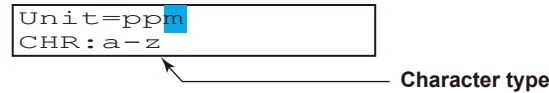

The character types change in the following order: uppercase alphabet (**A-Z**), lowercase alphabet (**a-z**), numbers (**0-9**), and symbols (**%-.**).

A-Z	A to Z, and space
a-z	a to z, and space
0-9	0 to 9, and space
%-.	%, #, °, @, +, -, *, /, (,), μ, Ω, ², ³, ., and space

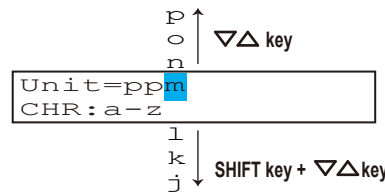

When you press the $\triangleleft \triangleright$ key, the change is applied and the next screen is displayed.

Inserting Characters

Press the $\triangleleft \triangleright$ key or **SHIFT** + $\triangleleft \triangleright$ key to move the cursor to the position where the character is to be inserted.

Press the **CHARACTER** key or **SHIFT** + **CHARACTER** key to show **Ins DISP** and then press the $\nabla \Delta$ key. A space for one character is inserted. Enter the character.

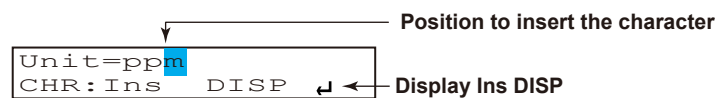

Deleting a Character

Use the $\triangleleft \triangleright$ key or **SHIFT** + $\triangleleft \triangleright$ key to move the cursor to the character to be deleted. Press the **CHARACTER** key or **SHIFT** + **CHARACTER** key to show **Del DISP** and then press the $\nabla \Delta$ key. The character is deleted.

Deleting an Entire Character String

Press the **CHARACTER** key or **SHIFT** + **CHARACTER** key to show **Clear DISP** and then press the $\nabla \Delta$ key. The entire character string is deleted.

Copying & Pasting a Character String

Show the copy source character string.

Press the **CHARACTER** key or **SHIFT** + **CHARACTER** key to show **Copy DISP** and then press the $\nabla \Delta$ key. The character string is saved to the memory.

Show the copy destination.

Press the **CHARACTER** key or **SHIFT** + **CHARACTER** key to show **Paste DISP** and then press the $\nabla \Delta$ key. The character string is pasted.

4.3 Menu Structure, Settings, and List of Default Values

Operation Menus Using the FUNC Key (Operation Mode)

Below are the items that are operated using the **FUNC** key. Information indicated inside the parentheses is references.

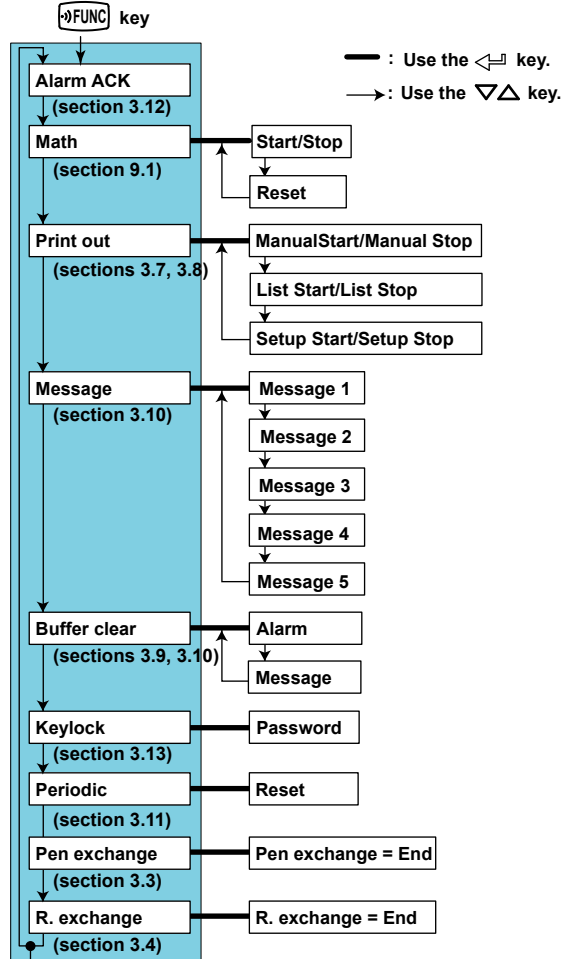

With the SD memory card (/EM1 option), “Data save,” “Data replay,” “SD card” (Eject) menu items are added.

Alarm ACK

Alarm output release operation. This operation is valid only when the alarm indication or relay output is set to hold operation.

Math (Models with the Computation Function (/M1 Option))

Starts/stops the computation.

Print out

Starts/Stops the manual printout or setting printout (List or Setup).

Message

Prints messages.

Buffer clear

Clears the data waiting to be printed in the alarm printout buffer or the message printout buffer.

Keylock

Activates or releases the key lock. This operation is possible only when the use of the key lock function is enabled.

Periodic

Resets the computed value when printing of the report data (average, etc.) is specified in periodic printout.

4.3 Menu Structure, Settings, and List of Default Values

Pen exchange (Pen Model)

Moves the recording pen to a position that is easily accessible for replacement on the pen model.

R. exchange (Dot Model)

Moves the printer carriage near the center position when replacing the ribbon cassette on the dot model.

Menu Structure of Setting Mode

Below are the setup items in Setting mode. Information indicated inside the parentheses is references.

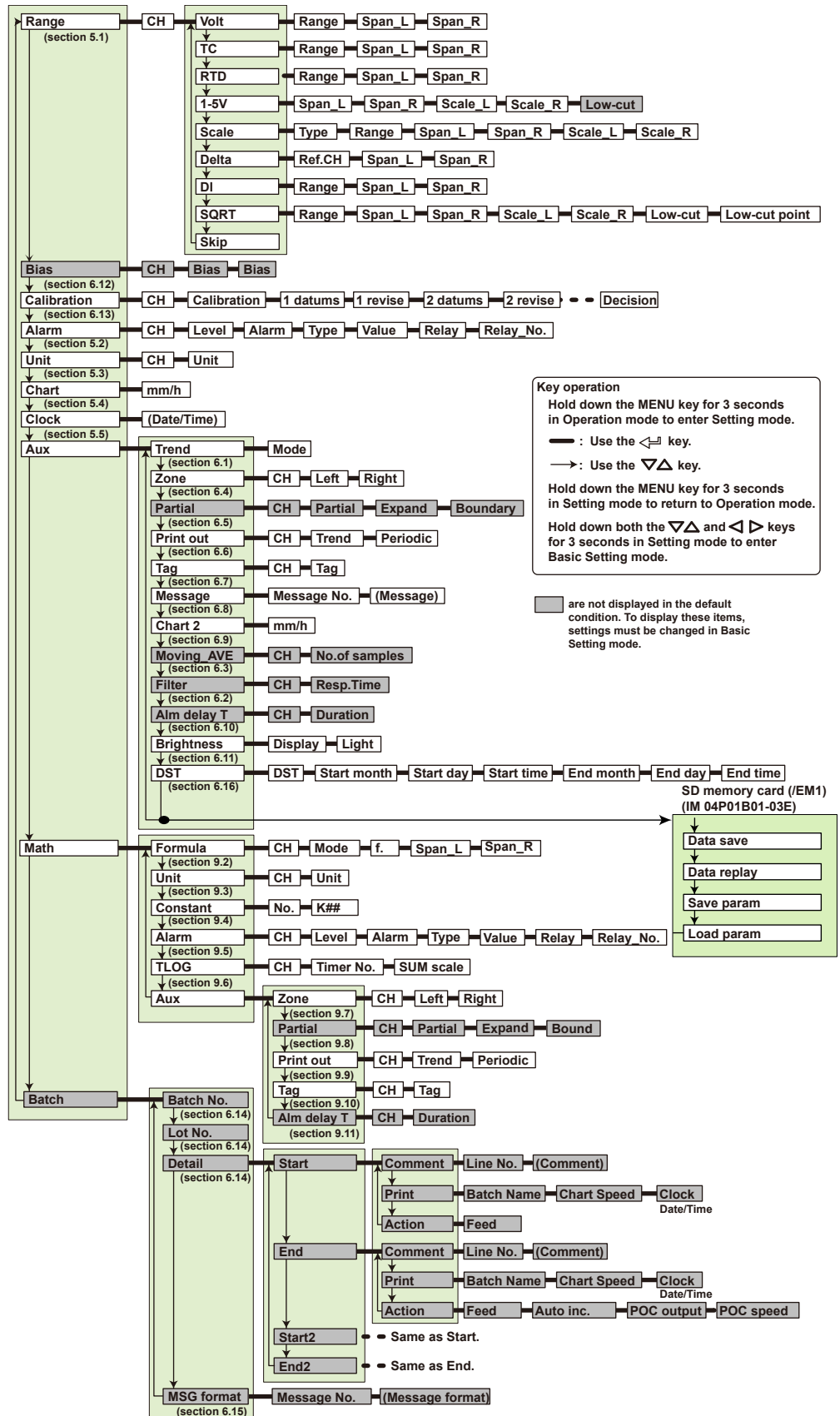

Menu Structure of Basic Setting Mode

Below are the setup items in Basic Setting mode. Information indicated inside the parentheses is references.

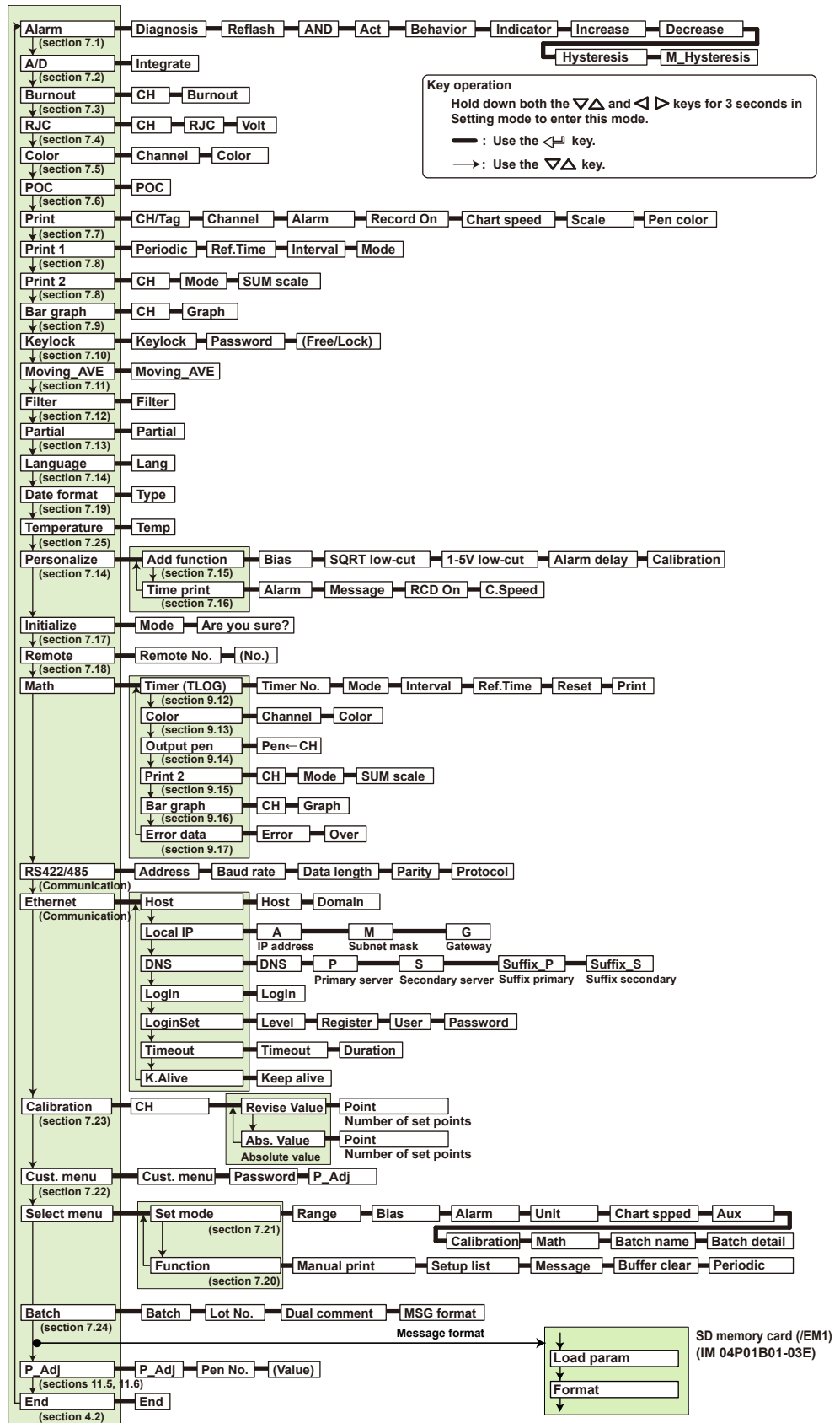

Setup Items in Setting Mode and Their Default Values

Items with an asterisk on the left are not displayed in the default condition. To display these items, settings must be changed in Basic Setting mode.

Setup Item	Pen/Dot	Selectable Range or Selections	Default Value
Range > CH	-	01 to 06	01
Range > Mode	-	Volt/TC/RTD/1-5V/Scale/Delta/DI/SQRT/Skip	Volt
Range > Mode > Range	-	20mV/60mV/200mV/2V/6V/20V/50V/1-5V/ R/S/B/K/E/J/T/N/W/L/U/WRe/Pt/JPt/Level/Cont/ (Selections for /N1 and /N3 options)	2V
*Bias > CH	-	01 to 06	01
*Bias > Bias	-	On/Off	Off
*Bias > Bias	-	±10% of the span of the measurable range or the scaling span	-
Calibration (/CC1 option)			
Calibration > CH	-	01 to 06	01
Calibration > Calibration	-	On/Off	Off
Calibration > datums	-	Within the range	-
Calibration > revise	-	Within the range (correction point + correction value for revise value)	-
Calibration > Decision	-	Yes/No	Yes
Alarm > CH	-	01 to 06	01
Alarm > Level	-	1/2/3/4	1
Alarm > Alarm	-	On/Off	Off
Alarm > Type	-	H/L/h/l/R/r (*T/t)	H
Alarm > Value	-	Depends on the alarm type.	-
Alarm > Relay	-	On/Off	Off
Alarm > Relay No.	-	I01 to I06	I01
Unit > CH	-	01 to 06	01
Unit > Unit	-	6 characters or less	Blank
Chart	Pen Model	82 types (pen model)	20 mm/h
	Dot Model	1 to 1500 mm/h (dot model)	20 mm/h
Clock	-	Date/Time	-
Aux > Trend	Dot Model	Auto/Fix	Auto
Aux > Zone > CH	-	01 to 06	01
Aux > Zone > Left, Right	-	Within the recording span range (mm)	Left: 0, Right: 100
*Aux > Partial > CH	-	01 to 06	01
*Aux > Partial > Partial	-	On/Off	Off
*Aux > Partial > Expand	-	1 to 99%	50
*Aux > Partial > Boundary	-	Within the recording span range	-
Aux > Print out > CH	-	01 to 06	01
Aux > Print out > Trend	Dot Model	On/Off	On
Aux > Print out > Periodic	-	On/Off	On
Aux > Tag > CH	-	01 to 06	01
Aux > Tag > Tag	-	7 characters or less	1 to 6
Aux > Message > Message No.	-	1 to 5	1
Aux > Message > (Message)	-	16 characters or less	Blank
Aux > Chart2	Pen Model	82 types (pen model)	20 mm/h
	Dot Model	1 to 1500 mm/h (dot model)	20 mm/h
*Aux > Moving_AVE > CH	Dot Model	01 to 06	01
*Aux > Moving_AVE > No. of samples	Dot Model	Off, 2 to 16	Off
*Aux > Filter > CH	Pen Model	01 to 06	01
*Aux > Filter > Resp. Time	Pen Model	2s/5s/10s	Off
*Aux > Alm delay T > CH	-	01 to 06	01
*Aux > Alm delay T > Duration	-	0 to 3600s	10s
Aux > Brightness > Display	-	1/2/3/4/5/6/7/8	4
Aux > Brightness > Light	-	1/2/3/4	2
SD memory card (/EM1 option)			
Aux > Data save > Start, Stop	-	Func menu > Record > Batch	FUNC menu
> Data replay > Mode	Dot Model	Original/Current	Original
> Save param > File	-	Up to 17 characters	-
> Load param > File	-	Search text	-

4.3 Menu Structure, Settings, and List of Default Values

Setup Item	Pen/Dot	Selectable Range or Selections	Default Value
Math (/M1 option)			
Math > Formula > CH	-	0A/0B/0C/0D/0E/0F/0G/0J/0K/0M/0N/0P	0A
Math > Formula > Mode	-	On/Off	Off
Math > Formula > f.	-	120 characters or less	01
Math > Unit > CH	-	0A/0B/0C/0D/0E/0F/0G/0J/0K/0M/0N/0P	0A
Math > Unit > Unit	-	6 characters or less	Blank
Math > Constant > No.	-	K01 to K30	K01
Math > Alarm > CH	-	0A/0B/0C/0D/0E/0F/0G/0J/0K/0M/0N/0P	0A
Math > Alarm > Level	-	1/2/3/4	1
Math > Alarm > Alarm	-	On/Off	Off
Math > Alarm > Type	-	H/L (*T/t)	H
Math > Alarm > Value	-	-9999999 to 99999999 excluding the decimal	-
Math > Alarm > Relay	-	On/Off	Off
Math > Alarm > Relay No.	-	I01 to I06	I01
Math > TLOG > CH	-	0A/0B/0C/0D/0E/0F/0G/0J/0K/0M/0N/0P	0A
Math > TLOG > Timer No.	-	Periodic/1/2	Periodic
Math > TLOG > SUM scale	-	Off, /s, /min, /h, /day	Off
Math > Aux > Zone > CH	-	0A/0B/0C/0D/0E/0F/0G/0J/0K/0M/0N/0P	0A
Math > Aux > Zone > Left, Right	-	Within the recording span range (mm)	Left: 0, Right: 100
*Math > Aux > Partial > CH	-	0A/0B/0C/0D/0E/0F/0G/0J/0K/0M/0N/0P	0A
*Math > Aux > Partial > Partial	-	On/Off	Off
*Math > Aux > Partial > Expand	-	1 to 99%	50
*Math > Aux > Partial > Bound	-	Within the recording span range	-
Math > Aux > Print out > CH	-	0A/0B/0C/0D/0E/0F/0G/0J/0K/0M/0N/0P	0A
Math > Aux > Print out > Trend	Dot Model	On/Off	On
Math > Aux > Print out > Periodic	-	On/Off	On
Math > Aux > Tag > CH	-	0A/0B/0C/0D/0E/0F/0G/0J/0K/0M/0N/0P	0A
Math > Aux > Tag > Tag	-	7 characters or less	A to P
*Math > Aux > Alm delay T > CH	-	0A/0B/0C/0D/0E/0F/0G/0J/0K/0M/0N/0P	0A
*Math > Aux > Alm delay T > Duration	-	0 to 3600s	10s
Batch (/BT1 option)			
*Batch > Batch No.	-	26 characters or less	Blank
*Batch > Lot No.	-	0000-9999 or 000000-999999	0000 or 000000
*Batch > Detail > Start > Comment > Line No.	-	1/2/3/4/5	1
*Batch > Detail > Start > Comment > (Comment)	-	32 characters or less	Blank
*Batch > Detail > Start > Print > Batch name	-	On/Off	On
*Batch > Detail > Start > Print > Chart speed	-	On/Off	On
*Batch > Detail > Start > Print > Clock	-	On/Off	On
*Batch > Detail > Start > Action > Feed	-	0 to 50 mm	0 mm
*Batch > Detail > End > Comment > Line No.	-	1/2/3/4/5	1
*Batch > Detail > End > Comment > (Comment)	-	32 characters or less	Blank
*Batch > Detail > End > Print > Batch name	-	On/Off	On
*Batch > Detail > End > Print > Chart speed	-	On/Off	On
*Batch > Detail > End > Print > Clock	-	On/Off	On
*Batch > Detail > End > Action > Feed	-	0 to 50 mm	0 mm
*Batch > Detail > End > Action > Auto inc.	-	On/Off	On
*Batch > Detail > End > Action > POC output	Pen Model	On/Off	Off
*Batch > Detail > End > Action > POC speed	Pen Model	C.Speed/450 mm h	C.Speed
*Batch > Detail > Start2 ... Same as Start			
*Batch > Detail > End2 ... Same as End			
*Batch > MSG format > Message No.	-	1/2/3/4/5	1
*Batch > MSG format > Message No. > (MSG format)	-	35 characters or less	H:M L16

Setup Items in Basic Setting Mode and Their Default Values

Setup Item	Pen/Dot	Selectable Range or Selections	Default Value
Alarm > Diagnosis	-	On/Off	Off
Alarm > Reflash	-	On/Off	Off
Alarm > AND	-	None/I01/I01-I02/I01-I03/I01-I04/I01-I05/I01-I06	None
Alarm > Act	-	Energize/De_energize	Energize
Alarm > Behavior	-	Nonhold/Hold	Nonhold
Alarm > Indicator	-	Nonhold/Hold	Nonhold
Alarm > Increase	-	01 to 15	01
Alarm > Decrease	-	01 to 15	01
Alarm > Hysteresis	-	Off/0.1% to 1.0%	0.5%
Alarm > M_Hysteresis	-	Off/0.1% to 1.0%	Off
A/D > Integrate	Dot Model	Auto/50Hz/60Hz/100ms	Auto
	Pen Model	Auto/50Hz/60Hz	Auto
Burnout > CH	-	01 to 06	01
Burnout > Burnout	-	Off/Up/Down	Off
RJC > CH	-	01 to 06	01
RJC > RJC	-	Internal/External	Internal
RJC > RJC > Volt	-	-20000 to 20000 μ V	0 μ V
Color > Channel	Dot Model	01 to 06	01
Color > Color	Dot Model	Purple/Red/Green/Blue/Brown/Black	01: Purple, 02: Red, 03: Green, 04: Blue, 05: Brown, 06: Black
POC > POC	Pen Model	On/Off	Off
Print > CH/Tag	-	CH/Tag	CH
Print > Channel	Dot Model	On/Off	On
Print > Alarm	-	On1/On2/Off	On1
Print > Record On	-	On/Off	Off
Print > Chart speed	-	On/Off	On
Print > Scale	-	On/Off	On
Print > Pen color	Pen Model	On/Off	On
Print1 > Periodic	-	Auto/Manual	Auto
Print1 > Ref. Time	-	Hour 0 to 23 (1 hour steps)	00:00
Print1 > Interval	-	10min/15min/20min/30min/1h/2h/3h/4h/6h/8h/12h/ 24h	1h
Print1 > Mode	-	Inst/Report/Off	Inst
Print2 > CH	-	01 to 06	01
Print2 > Mode	-	AVE/MIX/SUM/MIN/MAX/INST	AVE
Print2 > SUM scale	-	Off, /s, /min, /h, /day	Off
Bar graph > CH	-	01 to 06	01
Bar graph > Graph	-	Normal/Center	Normal
Keylock > Keylock	-	Not/Use	Not
Keylock > Password	-	Numbers and spaces within 4 digits	Blank
Keylock > RCD	-	Free/Lock	Free
Keylock > Feed	-	Free/Lock	Free
Keylock > Menu	-	Free/Lock	Free
Keylock > Disp Menu	-	Free/Lock	Free
Keylock > Alarm ACK	-	Free/Lock	Free
Keylock > Math	-	Free/Lock	Free
Keylock > Print out	-	Free/Lock	Free
Keylock > Message	-	Free/Lock	Free
Keylock > Buffer clear	-	Free/Lock	Free
Keylock > Periodic	-	Free/Lock	Free
Keylock > Pen exchange	Pen Model	Free/Lock	Free
Keylock > R. exchange	Dot Model	Free/Lock	Free
Keylock > Data save	-	Free/Lock	Free
Keylock > Data replay	Dot Model	Free/Lock	Free
Keylock > SD eject	-	Free/Lock	Free
Moving_AVE > Moving_AVE	Dot Model	Not/Use	Not
Filter > Filter	Pen Model	Not/Use	Not
Partial > Partial	-	Not/Use	Not

4.3 Menu Structure, Settings, and List of Default Values

Setup Item	Pen/Dot	Selectable Range or Selections	Default Value
Language > Lang	-	English/Japanese/German/French	English
Date format > Type	-	Y/M/D M/D/Y D/M/Y D.M.Y M.D.Y	M.D.Y
Temperature > Temp	-	°C/°F	°C
Personalize > Add function > Bias	-	Not/Use	Not
Personalize > Add function > SQRT low-cut	-	Not/Use	Use
Personalize > Add function > 1-5V low-cut	-	Not/Use	Not
Personalize > Add function > Alarm delay	-	Not/Use	Not
Personalize > Add function > Calibration	-	Not/Use	Use
Personalize > Time print > Alarm	-	HH:MM, HH:MM:SS, M/D H:M, M/D H:M:S, YMD H:M:S	HH:MM
Personalize > Time print > Message	-	HH:MM, HH:MM:SS, M/D H:M, M/D H:M:S, YMD H:M:S, None	HH:MM
Personalize > Time print > RCD On	-	HH:MM, HH:MM:SS, M/D H:M, M/D H:M:S, YMD H:M:S	HH:MM
Personalize > Time print > C.Speed	-	HH:MM, HH:MM:SS, M/D H:M, M/D H:M:S, YMD H:M:S	HH:MM
Setting initialization			
Initialize > Mode	-	Setup+Set/Set	Setup+Set
Initialize > Mode > Are you sure?	-	No/Yes	No
Remote (/R1 option)			
Remote > Remote No.	-	1/2/3/4/5	1
Remote > Remote No. > No.	-	Record On Off /Chart speed/Time adjust/ Math start stop (/M1)/Math reset (/M1)/ Manual print/Alarm ACK/Message1/Message2/ Message3/Message4/Message5/ Priority R_RCD (/BT1)/BatchCMT switch (/BT1)/ BatchCMT switch (/BT1)/Data save On/Off (/EM1)/ None (/M1, /BT1, /EM1: option)	Record On/Off
Math (/M1 option)			
Math > Timer (TLOG) > Timer No.	-	1/2	1
Math > Timer (TLOG) > Mode	-	Off/Relative/Absolute	Absolute
Math > Timer (TLOG) > Interval (Relative)	-	10 min to 24 h (1 min steps)	01:00
Math > Timer (TLOG) > Interval (Absolute)	-	10min/12min/15min/20min/30min/1h/2h/3h/4h/6h/ 8h/12h/24h	1h
Math > Timer (TLOG) > Ref. Time	-	Hour 0 to 23 (1 hour steps)	00:00
Math > Timer (TLOG) > Reset	-	On/Off	On
Math > Timer (TLOG) > Print	-	On/Off	On
Math > Color > Channel	Dot Model	0A/0B/0C/0D/0E/0F/0G/0J/0K/0M/0N/0P	0A
Math > Color > Color	Dot Model	Purple/Red/Green/Blue/Brown/Black	Purple: 0A/0G Red: 0B/0J Green: 0C/0K Blue: 0D/0M Brown: 0E/0N Black: 0F/0P
Math > Output pen > Pen ← CH	Pen Model	Pen: 1 to 4, Channel: 01 to 04/0A to 0J	1pen: 01, 2pen: 02, 3pen: 03, 4pen: 04,
Math > Print2 > CH	-	0A/0B/0C/0D/0E/0F/0G/0J/0K/0M/0N/0P	0A
Math > Print2 > Mode	-	AVE/MIX/SUM/MIN/MAX/INST	AVE
Math > Print2 > SUM scale	-	Off, /s, /min, /h, /day	Off
Math > Bar graph > CH	-	0A/0B/0C/0D/0E/0F/0G/0J/0K/0M/0N/0P	0A
Math > Bar graph > Graph	-	Normal/Center	Normal
Math > Error data > Error	-	+Over/-Over	+Over
Math > Error data > Over	-	Skip/Limit	Skip
RS-422/485 (/C3 option)			
RS-422/485 > Address	-	1 to 32	1
RS-422/485 > Baud rate	-	1200/2400/4800/9600/19200/38400	9600
RS-422/485 > Data length	-	7/8	8
RS-422/485 > parity	-	Odd/Even/None	Even
RS-422/485 > Protocol	-	NORMAL/MODBUS	NORMAL

4.3 Menu Structure, Settings, and List of Default Values

Setup Item	Pen/Dot	Selectable Range or Selections	Default Value
Ethernet (/C7 option)			
Ethernet > Host > Host	-	64 characters or less	Blank
Ethernet > Host > Domain	-	64 characters or less	Blank
Ethernet > Local IP > A	-	IP address	0.0.0.0
Ethernet > Local IP > M	-	IP address (Subnet mask)	0.0.0.0
Ethernet > Local IP > G	-	IP address (Default gateway)	0.0.0.0
Ethernet > DNS > DNS	-	On/Off	Off
Ethernet > DNS > P	-	IP address (Primary DNS sever)	0.0.0.0
Ethernet > DNS > S	-	IP address (Secondary DNS sever)	0.0.0.0
Ethernet > DNS > Suffix_P	-	Primary domain suffix	Blank
Ethernet > DNS > Suffix_S	-	Secondary domain suffix	Blank
Ethernet > Login > Login	-	Use/Not	Not
Ethernet > LoginSet > Level	-	Admin/User1 to User6	Admin
Ethernet > LoginSet > Register	-	On/Off	Admin and User1 are On
Ethernet > LoginSet > User	-	16 characters or less	Admin: admin User1 to 6: user1 to user6
Ethernet > LoginSet > Password	-	4 characters or less	Administrator: 0 User1 to 6: 1 to 6
Ethernet > Timeout > Timeout	-	On/Off	Off
Ethernet > Timeout > Duration	-	1 to 120 min	1 min
Ethernet > K. Alive > Keep alive	-	On/Off	On
Calibration (/CC1 option)			
Calibration > CH	-	01 to 06	01
Calibration > Mode	-	Revise Value, Abs. Value	Revise Value
Calibration > Point	-	2 to 16	2
Cust. menu > Cust. menu			
Cust. menu > Password	-	Numbers and spaces within 4 digits	Blank
Cust. menu > P_Adj	-	On/Off	Off
Select menu > Set mode > Range			
Select menu > Set mode > Bias	-	On/Off	On
Select menu > Set mode > Alarm	-	On/Off	On
Select menu > Set mode > Unit	-	On/Off	On
Select menu > Set mode > Chart speed	-	On/Off	On
Select menu > Set mode > Aux	-	On/Off	On
Select menu > Set mode > Calibration	-	On/Off	On
Select menu > Set mode > Math	-	On/Off	On
Select menu > Set mode > Batch name	-	On/Off	On
Select menu > Set mode > Batch detail	-	On/Off	On
Select menu > Function > Manual print	-	On/Off	On
Select menu > Function > Setup list	-	On/Off	On
Select menu > Function > Message	-	On/Off	On
Select menu > Function > Buffer clear	-	On/Off	On
Select menu > Function > Periodic	-	On/Off	On
Select menu > Function > Data save	-	On/Off	On
Select menu > Function > Data replay	Dot Model	On/Off	On
Select menu > Function > SD eject	-	On/Off	On
Batch (/BT1)			
Batch > Batch	-	Not/Use	Not
Batch > Lot No.	-	4/6/Not	4
Batch > Dual comment	-	Not/Use	Not
Batch > MSG format	-	Not/Use	Not
SD memory card (/EM1 option)			
Load param > File	-	Search text	-
Load param > Mode	-	Setup+Set/Setup	Setup+Set
Format > Label	-	Up to 11 characters	-
Format > Execute	-	Execute	Execute
Adjustment			
P_Adj > P_Adj	Dot Model	Hysteresis/Zero/Full	Hysteresis
	Pen Model	Zero/Full	Zero

4.3 Menu Structure, Settings, and List of Default Values

Setup Item	Pen/Dot	Selectable Range or Selections	Default Value
P_Adj > Pen No.	Pen Model	1/2/3/4	1
Store			
End > End	-	Store/Abort	Store

5.1 Setting the Input Range

Input range is set for each measurement channel. Set unused channels to Skip.

- The input range cannot be changed on models with the computation function (/M1 option) when computation is in progress.
- If you change the input range, set the bias, alarm, partial expanded recording, and calibration correction again.

Procedure

TC, RTD, and DC Voltage

1. Hold down the **MENU** key for 3 seconds to enter Setting mode.
2. Press the **↵** key with **Range** shown on the screen.
3. Set each item and press the **↵** key.
Use the **▽△** key or **SHIFT + ▽△** key to select values.
For the procedure on how to enter values or characters, see section 4.2.
If you press the **ESC** key in the middle of the operation, the settings entered up to then are cancelled, and the display returns to a higher level menu.
4. When the **Setting complete** screen appears, do either of the following:
Press the **↵** key to set other channels.
If you are done, press the **ESC** key.
5. Hold down the **MENU** key for 3 seconds to return to Operation mode.

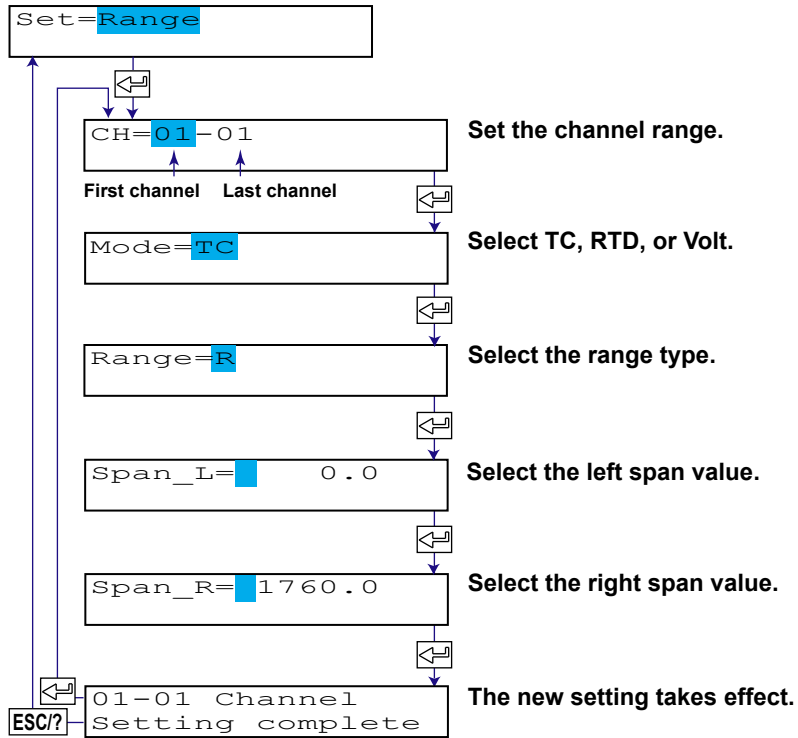

5.1 Setting the Input Range

Description

- **Selectable Range of Input Range, Span Left, and Span Right**

The input range, span left, and span right can be set in the range shown below. Span left and span right cannot be set to the same value.

DC voltage (Volt)

Range Type	Selectable Span Range
20 mV	-20.00 to 20.00 mV
60 mV	-60.00 to 60.00 mV
200 mV	-200.0 to 200.0 mV
2 V	-2.000 to 2.000 V
6 V	-6.000 to 6.000 V
20 V	-20.00 to 20.00 V
50 V	-50.00 to 50.00 V

Thermocouple (TC)

Range Type	Selectable Span Range (°C)	Selectable Span Range (°F)
R	0.0 to 1760.0°C	32 to 3200°F
S	0.0 to 1760.0°C	32 to 3200°F
B	0.0 to 1820.0°C	32 to 3308°F
K	-200.0 to 1370.0°C	-328 to 2498°F
E	-200.0 to 800.0°C	-328.0 to 1472.0°F
J	-200.0 to 1100.0°C	-328.0 to 2012.0°F
T	-200.0 to 400.0°C	-328.0 to 752.0°F
N	0.0 to 1300.0°C	32 to 2372°F
W	0.0 to 2315.0°C	32 to 4199°F
L	-200.0 to 900.0°C	-328.0 to 1652.0°F
U	-200.0 to 400.0°C	-328.0 to 752.0°F
WRe	0.0 to 2400.0°C	32 to 4352°F

RTD

Range Type	Selectable Span Range (°C)	Selectable Span Range (°F)
PT (Pt100)	-200.0 to 600.0°C	-328.0 to 1112.0°F
JPT (JPt100)	-200.0 to 550.0°C	-328.0 to 1022.0°F

RTD

Range Type	Selectable Span Range (°C)	Selectable Span Range (°F)
PT (Pt100)	-200.0 to 600.0°C	-328.0 to 1112.0°F
JPT (JPt100)	-200.0 to 550.0°C	-328.0 to 1022.0°F

/N1 Option

Selections	Input Type
Cu1	Cu10 (GE)
Cu2	Cu10 (L&N)
Cu3	Cu10 (WEED)
Cu4	Cu10 (BAILEY)
Cu5	Cu10: a = 0.00392 at 20°C
Cu6	Cu10: a = 0.00393 at 20°C
Cu25	Cu25*: a = 0.00425 at 0°C

/N3 Option

Selections	Input Type	Note
PR	PR40-20	Thermo couple
PLATI	PLATINEL	
NiMo	NiNiMo	
W/WRe	W/WRe26	
N2	Type N (AWG14)	
Kp	Kp vs Au7Fe	RTD
Pt4	Pt25	
Pt3	Pt50	
Ni1	Ni100 (SAMA)	
Ni2	Ni100 (DIN)	
Ni3	Ni120	
J263	J263*B	
Cu8	Cu53	
Cu9	Cu100: a = 0.00425 at 0°C	

Linear Scaling

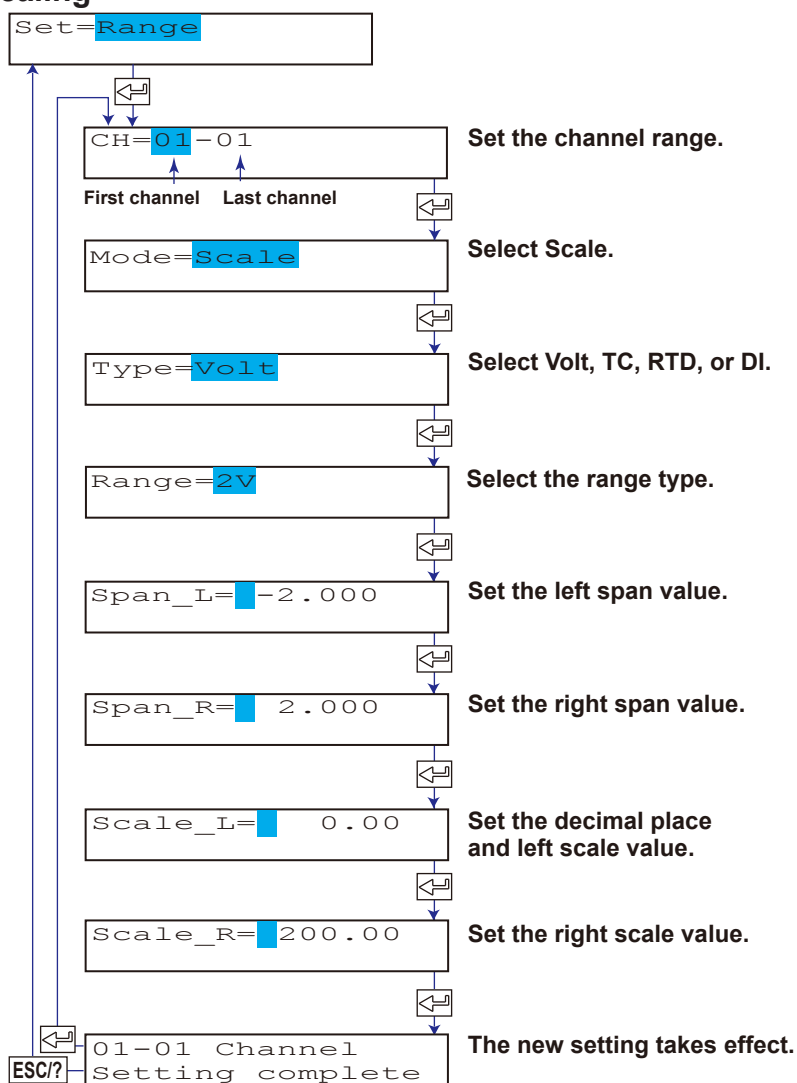

Description

- **Scale Left, Scale Right, and Decimal Place**

Selectable range (mantissa): -20000 to 30000

Example: The value in the range of -100.00 to 350.00 cannot be specified. The mantissa of Scale_R is 35000, which exceeds the upper limit of 30000. Set in the range of -100.0 to 350.0.

Decimal place: XXXXX, XXXX.X, XXX.XX, XX.XXX, X.XXXX

The decimal place is set using Scale_L. It cannot be set using Scale_R.

Example: Change 0.00 to 0.0.

Press the <|> key to move the cursor to the last digit of 0.00.

Press the ▽/△ key to change the value to 0.0 .

Space →↑

Note

The displayable/printable range of scale values is -19999 to 30000 excluding the decimal.

<Related Topics> Setting the unit: Section 5.3

Delta Computation

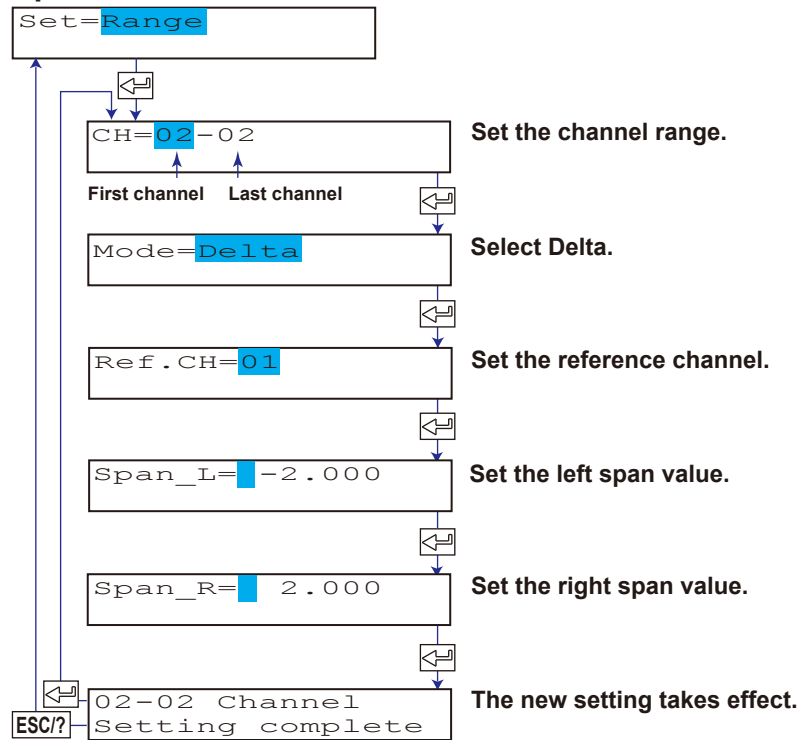

Description

- Reference Channel**
 The reference channel must be a channel that is smaller in channel number than the channel being set.
- Span Left and Span Right**
 The range type is set to the same type as the reference channel. The span left and span right can be set in the range shown below. Span left and span right cannot be set to the same value.

Input Type	Range Type	Selectable Span Range	
DC voltage (Volt)	20 mV	-20.00 to 20.00 mV	
	60 mV	-60.00 to 60.00 mV	
	200 mV	-200.0 to 200.0 mV	
	2 V	-2.000 to 2.000 V	
	6 V	-6.000 to 6.000 V	
	20 V	-20.00 to 20.00 V	
	50 V	-50.00 to 50.00 V	
Thermocouple (TC)	R	-1760.0 to 1760.0°C	-3168 to 3168°F
	S	-1760.0 to 1760.0°C	-3168 to 3168°F
	B	-1820.0 to 1820.0°C	-3276 to 3276°F
	K	-1570.0 to 1570.0°C	-2826 to 2826°F
	E	-1000.0 to 1000.0°C	-1800 to 1800°F
	J	-1300.0 to 1300.0°C	-1999.9 to 2340.0°F
	T	-600.0 to 600.0°C	-1080.0 to 1080.0°F
	N	-1300.0 to 1300.0°C	-2340 to 2340°F
	W	-1999.9 to 2315.0°C	-4167 to 4167°F
	L	-1100.0 to 1100.0°C	-1980 to 1980°F
	U	-600.0 to 600.0°C	-1080.0 to 1080.0°F
WRe	-1999.9 to 2400.0°C	-4320 to 4320°F	
RTD	PT (Pt100)	-800.0 to 800.0°C	-1440.0 to 1440.0°F
	JPT (JPt100)	-750.0 to 750.0°C	-1350.0 to 1350.0°F

ON/OFF Input

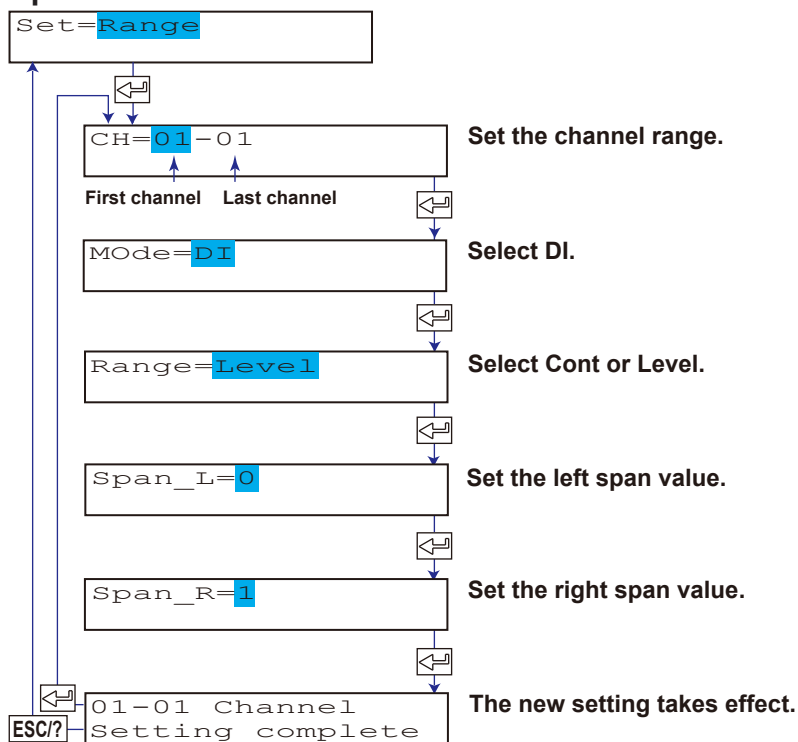

Description

- Selectable Range Type, Span Left, and Span Right**

The range type, span left, and span right can be set in the range shown below. Span left and span right cannot be set to the same value.

Range Type	Selectable Span Values
Level	0: Less than 2.4 V, 1: 2.4 V or higher, within ± 6 V
Contact	0: Open, 1: Closed

1-5V Input

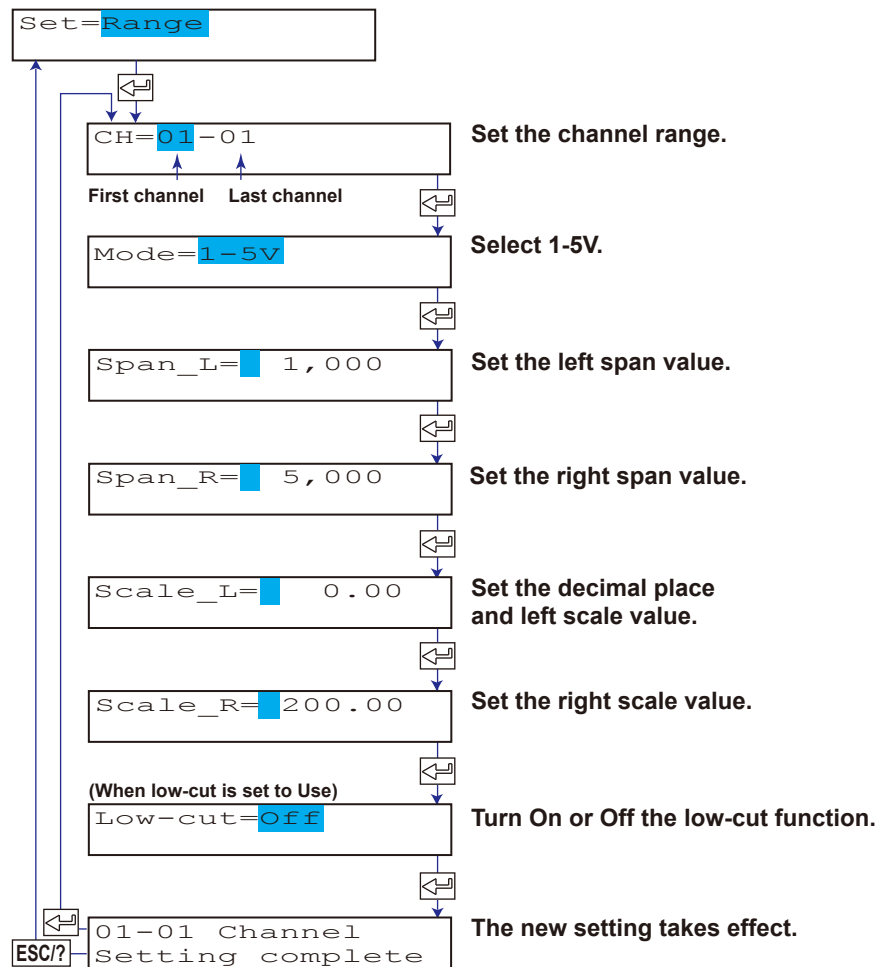

Description

- Span Left and Span Right**

Selectable span left range: 0.8 to 1.2 V
 Selectable span right range: 4.8 to 5.2 V

- Scale Left, Scale Right, and Decimal Place**

Selectable range (mantissa): -20000 to 30000

Example: The value in the range of -100.00 to 350.00 cannot be specified. The mantissa of Scale_R is 35000, which exceeds the upper limit of 30000. Set in the range of -100.0 to 350.0.

Decimal place: XXXXX, XXXX.X, XXX.XX, XX.XXX, X.XXXX

The decimal place is set using Scale_L. It cannot be set using Scale_R.

Example: Change 0.00 to 0.0.

Press the <◀▶ key to move the cursor to the last digit of 0.00.

Press the ▼▲ key to change the value to 0.0 .

Space →↑

Make sure that scale left is less than scale right.

- Low-cut**

On: Cuts values below 0% of the recording span (set to 0% (scale left value)).

Off: Does not apply the low-cut function.

<Related Topics> Setting the unit: Section 5.3

Enabling the low-cut function: Section 7.15

Note

- The displayable/printable range of scale values is –19999 to 30000 excluding the decimal.
- If the leftmost value of the scale is set to –20000 (excluding the decimal), the value when the low-cut function is applied is displayed as “–Over.”

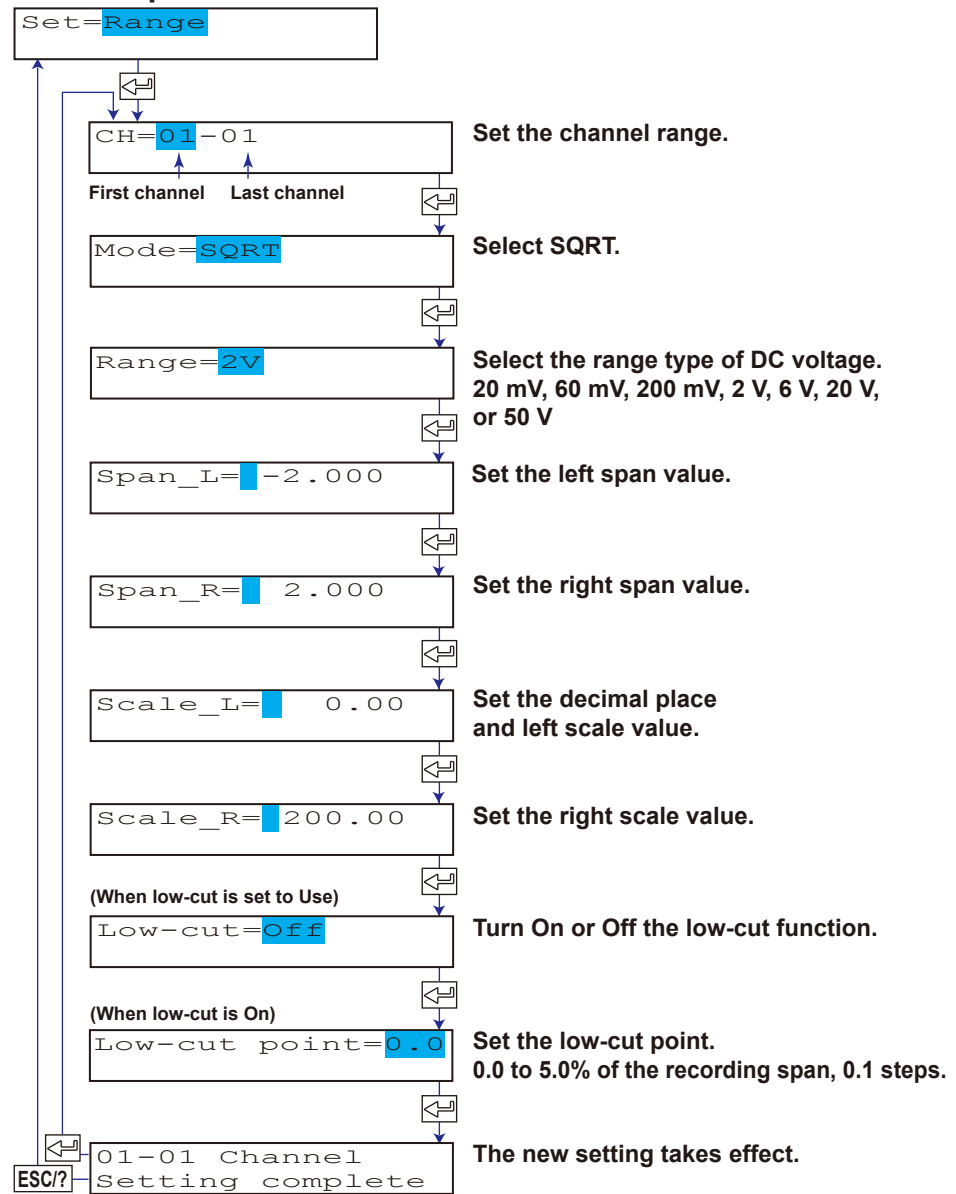
Square Root Computation**Description**

- **Input Type in Which Square Root Computation Can Be Performed**
Square root computation can be performed when set to DC voltage input.
- **Span Left and Span Right**
Same as the selectable span range of the DC voltage input.
Make sure that span left is less than span right.

5.1 Setting the Input Range

- **Scale Left, Scale Right, and Decimal Place**

Selectable range (mantissa): -20000 to 30000

Example: The value in the range of -100.00 to 350.00 cannot be specified. The mantissa of Scale_R is 35000, which exceeds the upper limit of 30000. Set in the range of -100.0 to 350.0.

Decimal place: XXXXX, XXXX.X, XXX.XX, XX.XXX, X.XXXX

The decimal place is set using Scale_L. It cannot be set using Scale_R.

Example: Change 0.00 to 0.0.

Press the < > key to move the cursor to the last digit of 0.00.

Press the ▽△ key to change the value to 0.0 .
Space →↑

- **Low-cut and Low-cut Point**

If low-cut is set to On, set the low-cut point.

Selectable range of the low-cut point: 0.0 to 5.0% of the recording span

Values below the low-cut point is set to 0% (scale left value) of the recording span.

Note

- The displayable/printable range of scale values is -19999 to 30000 excluding the decimal.
- If the leftmost value of the scale is set to -20000 (excluding the decimal) and the low-cut value is set to -20000, the value when the low-cut function is applied is displayed as “-Over.”

<Related Topics> Setting the unit: Section 5.3

Enabling the low-cut function: Section 7.15

Skip (Unused Channels)

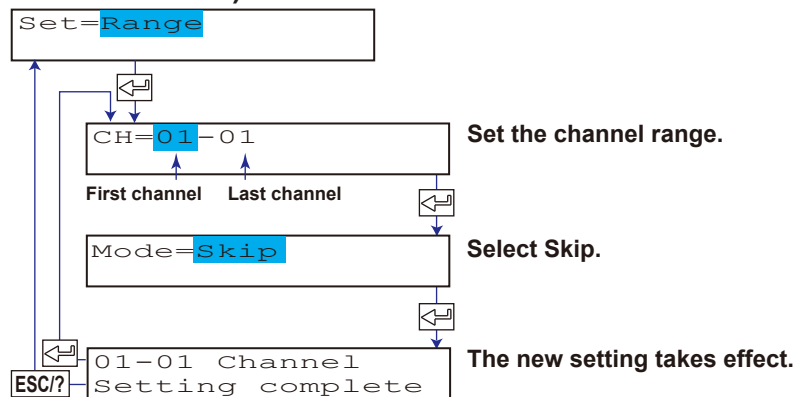

Note

Do not use channels set to skip as a reference channel of delta computations or in computing equations of the computation function (/M1 option).

5.2 Setting the Alarm

The alarm is set for each channel.
If you change the input range, set the alarm again.

Procedure

1. Hold down the **MENU** key for 3 seconds to enter Setting mode.
2. Press the **▽△** key or **SHIFT + ▽△** key to select **Alarm** and then press the **↵** key.
3. Set each item and press the **↵** key.
Use the **▽△** key or **SHIFT + ▽△** key to select values.
For the procedure on how to enter values or characters, see section 4.2.
If you press the **ESC** key in the middle of the operation, the settings entered up to then are cancelled, and the display returns to a higher level menu.
4. When the **Setting complete** screen appears, do either of the following:
Press the **↵** key to set other channels.
If you are done, press the **ESC** key.
5. Hold down the **MENU** key for 3 seconds to return to Operation mode.

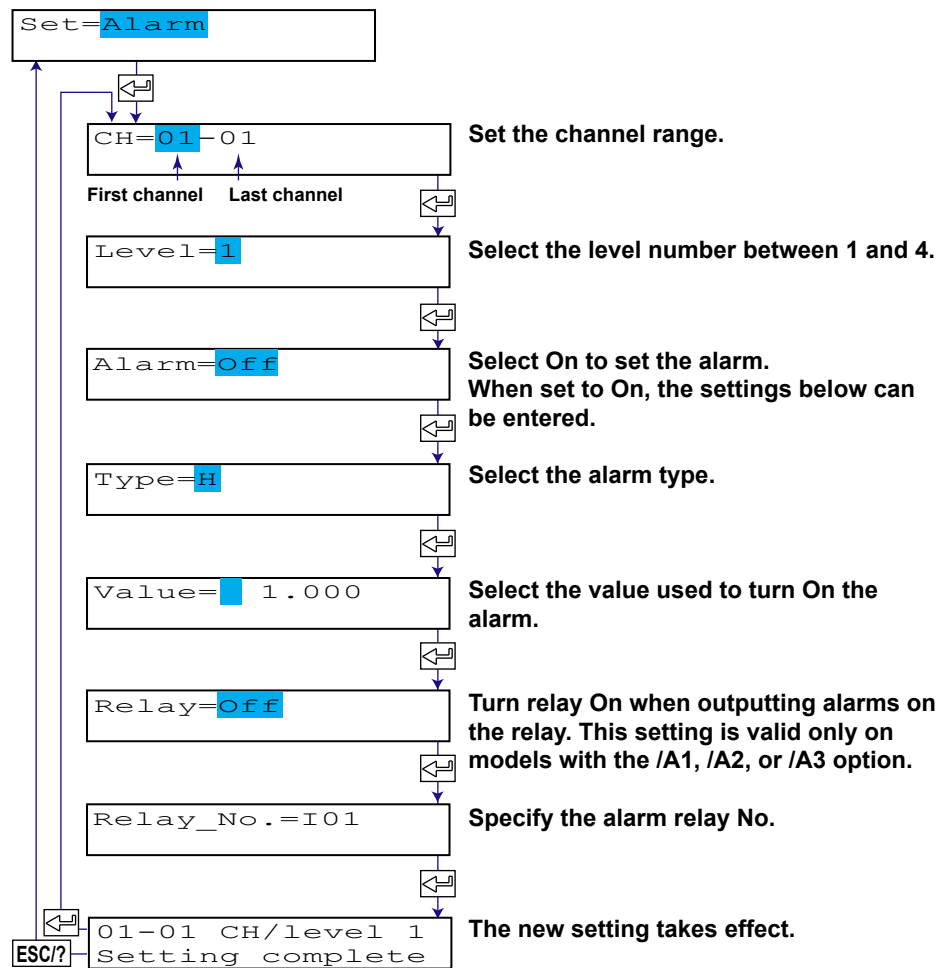

5.2 Setting the Alarm

Explanation

Channel Range

The only case when an alarm can be set on multiple channels simultaneously is when the channels are set to the same range type (for example channel 01 and 02 are set to 2 V range). For channels on which scaling is set, the channels must be set to the same range type, same span values, and same scaling values.

Alarm Type

Symbol	Name	Note
H	High limit alarm	
L	Low limit alarm	
h	Difference high limit alarm	Can be specified on channels set to delta computation.
l	Difference low limit alarm	Can be specified on channels set to delta computation.
R	High limit on rate-of-change alarm	
r	Low limit on rate-of-change alarm	
T	Delay high limit alarm*	
t	Delay low limit alarm*	

* Selectable only when the alarm delay function is enabled. See section 7.15.

Note

On channels set to delta computation, alarms can be detected on the values illustrated in the figure below.

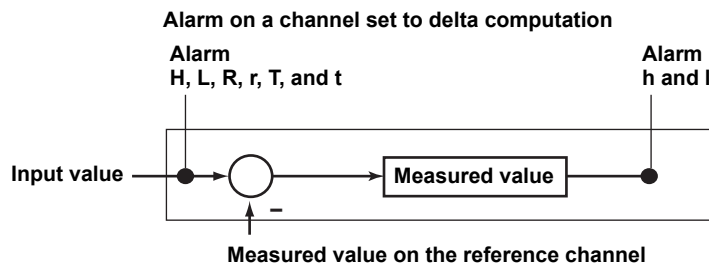

If high limit on rate-of-change alarm or low limit on rate-of-change alarm is specified, set the interval over which the rate-of-change is calculated.

If delay high limit alarm or delay low limit alarm is specified, set the delay time.

- <Related Topics>** Setting the interval of the high limit on rate-of-change alarm or low limit on rate-of-change alarm: Section 7.1
Setting the delay time of delay high limit alarm or delay low limit alarm: Section 6.10
Enabling the alarm delay function: Section 7.15
Setting the alarm hysteresis: Section 7.1

Alarm Value**• High Limit Alarm/Low Limit Alarm and Delay High Limit Alarm/Delay Low Limit Alarm**

The following values can be specified.

- For DC voltage, TC, and RTD input: Values within the measurable range in the specified range (example: –2.000 to 2.000 V for the 2 V range).
- For ON/OFF input (DI): 0 or 1.
- For linear scaling (1-5V, scaling, and square root): A value within –5 to 105% of the scaling span (version 1.11 or later) except within the range of –20000 to 30000 (excluding the decimal point).

Note

For channels whose the leftmost value of the scale is set to –20000 (excluding the decimal), the alarm value of –20000 is invalid. Set a value that is greater than or equal –19999.

• Difference High Limit Alarm/Difference Low Limit Alarm

Values in the measurable range can be specified. Measurable range refers to “Selectable Span Range” in the table on page 5-4.

• High Limit on Rate-of-Change Alarm/Low Limit on Rate-of-Change Alarm

A value greater than or equal to 1 digit can be specified. For example, 1 digit corresponds 0.001 for the 2 V range (measurable range: –2.000 to 2.000 V). The maximum value that can be specified is the width of the measurable range (4.000 V for 2 V range).

For ON/OFF input, only “1” can be specified.

Relay No.

The selectable relay numbers are listed below.

I01 and I02 on the /A1 option

I01, I02, I03, and I04 on the /A2 option

I01, I02, I03, I04, I05, and I06 on the /A3 option

5.3 Setting the Unit on Scaled Channels

Units are set on channels whose input range is set to Scaling, 1-5V, or SQRT.

Procedure

1. Hold down the **MENU** key for 3 seconds to enter Setting mode.
2. Press the $\nabla\Delta$ key or **SHIFT** + $\nabla\Delta$ key to select **Unit** and then press the \leftarrow key.
3. Set each item and press the \leftarrow key.
Use the $\nabla\Delta$ key or **SHIFT** + $\nabla\Delta$ key to select values.
For the procedure on how to enter values or characters, see section 4.2.
If you press the **ESC** key in the middle of the operation, the settings entered up to then are cancelled, and the display returns to a higher level menu.
4. When the **Setting complete** screen appears, do either of the following:
Press the \leftarrow key to set other channels.
If you are done, press the **ESC** key.
5. Hold down the **MENU** key for 3 seconds to return to Operation mode.

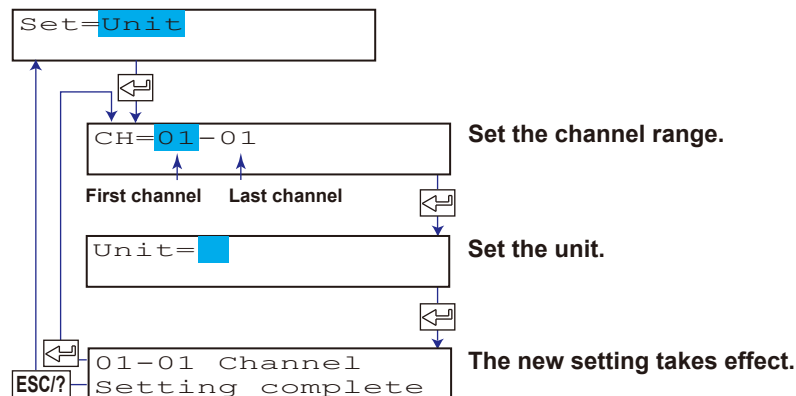

Explanation

Characters That Can Be Used for Units

A unit is set using up to six characters.

The available characters are as follows:

Alphabet, numbers, symbols (% , # , ° , @ , + , - , * , / , (,) , μ , Ω , ² , ³ , .), and space

<Related Topics> Entering the unit string: Page 25 in the μ R10000 Recorder Operation Guide

5.4 Changing the Chart Speed

This section explains the details of changing the chart speed.

Procedure

1. Hold down the **MENU** key for 3 seconds to enter Setting mode.
2. Press the **▽△** key or **SHIFT + ▽△** key to select **Chart** and then press the **↵** key.
3. Set the chart speed and press the **↵** key.
Use the **▽△** key or **SHIFT + ▽△** key to select values.
For the procedure on how to enter values or characters, see section 4.2.
If you press the **ESC** key in the middle of the operation, the settings entered up to then are cancelled, and the display returns to a higher level menu.
4. When the **Setting complete** screen appears, do either of the following:
To correct the setting, press the **↵** key.
If you are done, press the **ESC** key.
5. Hold down the **MENU** key for 3 seconds to return to Operation mode.

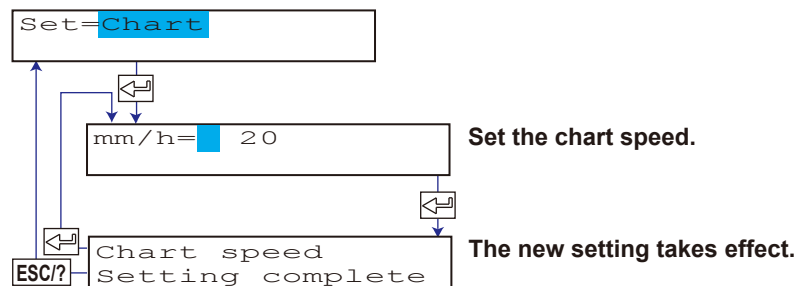

Explanation

Chart Speed

• Pen Model

The chart speed can be selected from 82 settings shown below.

Chart speed on the pen model (unit: mm/h)

5	6	8	9	10	12	15	16	18	20
24	25	30	32	36	40	45	48	50	54
60	64	72	75	80	90	96	100	120	125
135	150	160	180	200	225	240	250	270	300
320	360	375	400	450	480	500	540	600	675
720	750	800	900	960	1000	1080	1200	1350	1440
1500	1600	1800	2000	2160	2250	2400	2700	2880	3000
3600	4000	4320	4500	4800	5400	6000	7200	8000	9000
10800	12000								

• Dot Model

The chart speed can be set in the range of 1 to 1500 mm/h in 1 mm steps.

5.5 Setting the Date/Time

This section explains the details of setting the date/time.

Procedure

1. Hold down the **MENU** key for 3 seconds to enter Setting mode.
2. Press the **▽△** key or **SHIFT + ▽△** key to select **Clock** and then press the **↵** key.
3. Set the date and time and press the **↵** key.
Use the **▽△** key or **SHIFT + ▽△** key to select values.
For the procedure on how to enter values or characters, see section 4.2.
If you press the **ESC** key in the middle of the operation, the settings entered up to then are cancelled, and the display returns to a higher level menu.
4. When the **Setting complete** screen appears, do either of the following:
To correct the setting, press the **↵** key.
If you are done, press the **ESC** key.
5. Hold down the **MENU** key for 3 seconds to return to Operation mode.

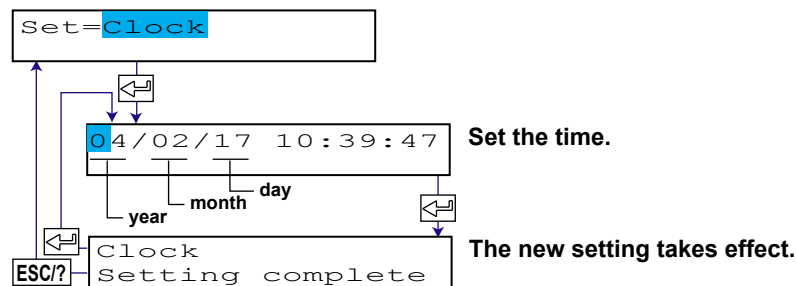

Explanation

Date/Time

The year is set with the lower two digits.

Values in the range 80 and 99 correspond to 1980 to 1999.

The values that can be entered are as follows. Entering a value outside this range or an invalid date results in an error, and the date and time do not change.

Month: 01 to 12, Day: 01 to 31, Hour: 00 to 23, Minute: 00 to 59, Second: 00 to 59

<Related Topics> Changing the printout/display format of the date : Section 7.19

6.1 Setting the Trend Recording Interval (Dot Model)

This section explains the details of setting the trend recording interval (dot printing interval) on the dot model.

Procedure

1. Hold down the **MENU** key for 3 seconds to enter Setting mode.
2. Press the **▽△** key or **SHIFT + ▽△** key to select Aux and then press the **↵** key.
3. Press the **▽△** key or **SHIFT + ▽△** key to select **Trend** and then press the **↵** key.
4. Set the dot printing interval and press the **↵** key.
Use the **▽△** key or **SHIFT + ▽△** key to select values.
For the procedure on how to enter values or characters, see section 4.2.
If you press the **ESC** key in the middle of the operation, the settings entered up to then are cancelled, and the display returns to a higher level menu.
5. When the **Setting complete** screen appears, do either of the following:
To correct the setting, press the **↵** key.
If you are done, press the **ESC** key.
6. Hold down the **MENU** key for 3 seconds to return to Operation mode.

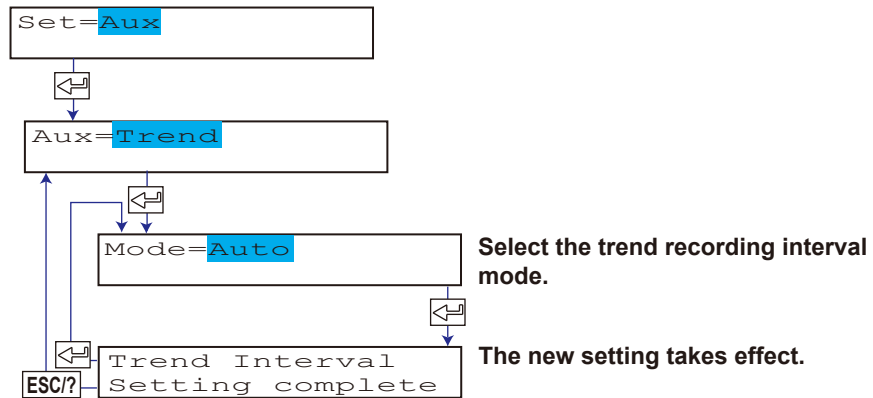

Explanation

Mode

- Auto:** The trend recording interval is set according to the chart speed in the range of 10 s to 90 s so that the dots do not overlap many times. The interval is displayed on the System display (see page 12-9).
- Fix:** The trend recording interval is fixed to 10 s/6 dots. On models with the computation function (/M1 option), the trend recording interval varies depending on the number of measurement and computation channels to be trend recorded.

Number of channels to be recorded	Trend recording interval
6 or less	10 s
7 to 12	15 s
13 to 18	20 s

When set to Auto When set to Fix

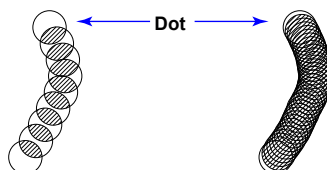

The distance between dots printed on the chart paper varies depending on the chart speed.

6.1 Setting the Trend Recording Interval (Dot Model)

Example of calculating the dot printing interval when the trend recording interval is set to auto

μR10000 6-dot model

A/D integrate: Auto

Chart speed: 23 mm/h

Number of recording channels: 6 channels

Scan interval = 1 s

A value that is less than or equal to $900 \div \text{chart speed}$ and that is the largest integer multiple of the scan interval = 39 s

Because this 39 s is within the range of the fastest (= 10 s) to 90 s, recording interval = 39.0 s

6.2 Setting the Filter (Pen Model)

This section explains the details of setting a filter on the measurement channels on the pen model.

Procedure

1. Hold down the **MENU** key for 3 seconds to enter Setting mode.
2. Press the $\nabla\Delta$ key or **SHIFT** + $\nabla\Delta$ key to select **Aux** and then press the \leftarrow key.
3. Press the $\nabla\Delta$ key or **SHIFT** + $\nabla\Delta$ key to select **Filter** and then press the \leftarrow key.
4. Set each item and press the \leftarrow key.
Use the $\nabla\Delta$ key or **SHIFT** + $\nabla\Delta$ key to select values.
For the procedure on how to enter values or characters, see section 4.2.
If you press the **ESC** key in the middle of the operation, the settings entered up to then are cancelled, and the display returns to a higher level menu.
5. When the **Setting complete** screen appears, do either of the following:
Press the \leftarrow key to set other channels.
If you are done, press the **ESC** key.
6. Hold down the **MENU** key for 3 seconds to return to Operation mode.

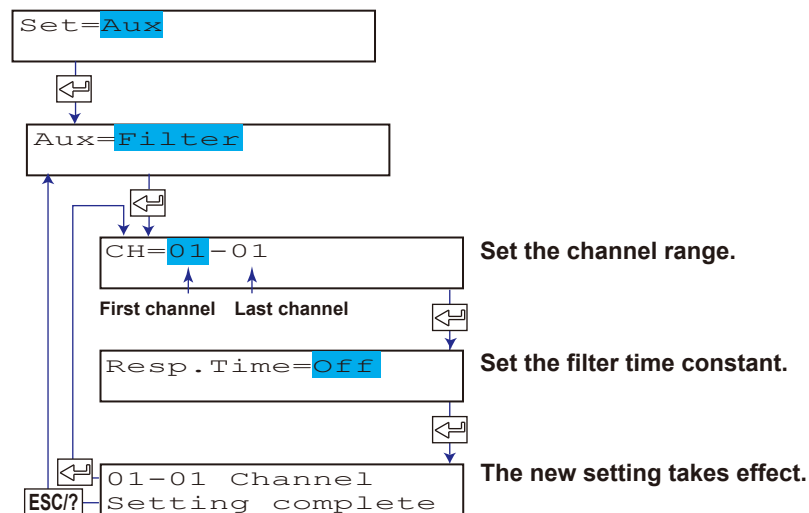

Explanation

Filter Time Constant

The time constant is selectable from 2 s, 5 s, and 10 s. Select Off when not using the filter.

<Related Topics> Enabling the filter function: Section 7.12

6.3 Setting the Moving Average (Dot Model)

This section explains the details of setting the moving average function on measurement channels on the dot model.

Procedure

1. Hold down the **MENU** key for 3 seconds to enter Setting mode.
2. Press the $\nabla\Delta$ key or **SHIFT** + $\nabla\Delta$ key to select **Aux** and then press the \leftarrow key.
3. Press the $\nabla\Delta$ key or **SHIFT** + $\nabla\Delta$ key to select **Moving_AVE** and then press the \leftarrow key.
4. Set each item and press the \leftarrow key.
Use the $\nabla\Delta$ key or **SHIFT** + $\nabla\Delta$ key to select values.
For the procedure on how to enter values or characters, see section 4.2.
If you press the **ESC** key in the middle of the operation, the settings entered up to then are cancelled, and the display returns to a higher level menu.
5. When the **Setting complete** screen appears, do either of the following:
Press the \leftarrow key to set other channels.
If you are done, press the **ESC** key.
6. Hold down the **MENU** key for 3 seconds to return to Operation mode.

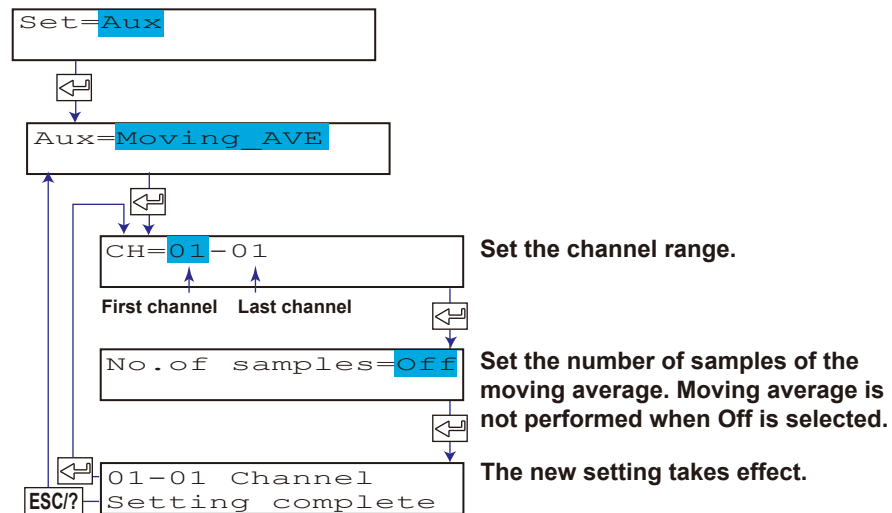

Explanation

The Number of Samples of Moving Average

The number of samples can be set to an integer between 2 and 16. Select Off when not using the moving average function.

<Related Topics> Enabling the moving average function: Section 7.11

6.4 Setting Recording Zones for Each Channel (Zone Recording)

This section explains the details of setting the recording zone for each measurement channel.

Procedure

1. Hold down the **MENU** key for 3 seconds to enter Setting mode.
2. Press the $\nabla\Delta$ key or **SHIFT + $\nabla\Delta$** key to select **Aux** and then press the \leftarrow key.
3. Press the $\nabla\Delta$ key or **SHIFT + $\nabla\Delta$** key to select **Zone** and then press the \leftarrow key.
4. Set each item and press the \leftarrow key.
Use the $\nabla\Delta$ key or **SHIFT + $\nabla\Delta$** key to select values.
For the procedure on how to enter values or characters, see section 4.2.
If you press the **ESC** key in the middle of the operation, the settings entered up to then are cancelled, and the display returns to a higher level menu.
5. When the **Setting complete** screen appears, do either of the following:
Press the \leftarrow key to set other channels.
If you are done, press the **ESC** key.
6. Hold down the **MENU** key for 3 seconds to return to Operation mode.

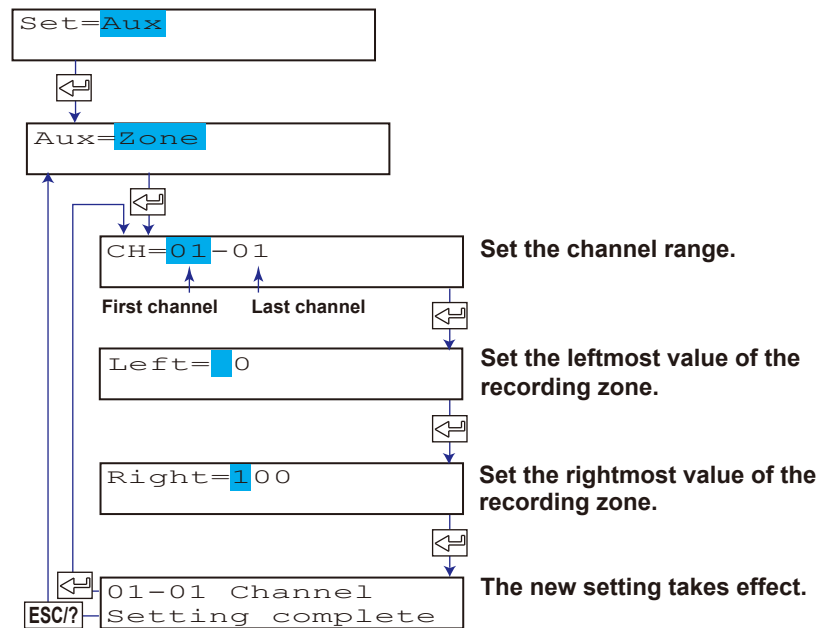

Explanation

Zone

The recording zone can be set in the following range.

Leftmost position: 0 mm to 95 mm

Rightmost position: 5 mm to 100 mm

Set a larger value for the rightmost position than the leftmost position.

Set at least 5 mm for the zone width.

Note

If the zone is set to a value less than 40 mm, scale printout of periodic printout cannot be executed.

6.5 Setting the Partial Expanded Recording

This section explains the details of expanding a section of the recording range. If you change the input range, set the partial expanded recording again.

Procedure

1. Hold down the **MENU** key for 3 seconds to enter Setting mode.
2. Press the $\nabla\Delta$ key or **SHIFT** + $\nabla\Delta$ key to select **Aux** and then press the \leftarrow key.
3. Press the $\nabla\Delta$ key or **SHIFT** + $\nabla\Delta$ key to select **Partial** and then press the \leftarrow key.
4. Set each item and press the \leftarrow key.
Use the $\nabla\Delta$ key or **SHIFT** + $\nabla\Delta$ key to select values.
For the procedure on how to enter values or characters, see section 4.2.
If you press the **ESC** key in the middle of the operation, the settings entered up to then are cancelled, and the display returns to a higher level menu.
5. When the **Setting complete** screen appears, do either of the following:
Press the \leftarrow key to set other channels.
If you are done, press the **ESC** key.
6. Hold down the **MENU** key for 3 seconds to return to Operation mode.

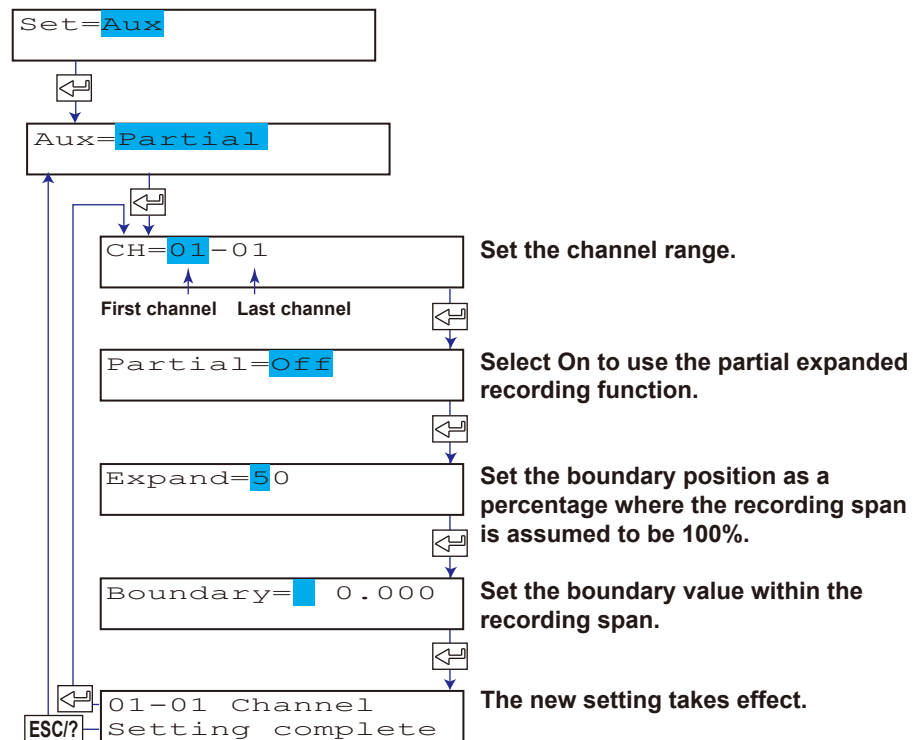

Explanation

Expand

Set a value between 1 and 99%. One percent corresponds to 1 mm, because the record width is 100 mm.

Example: To record 0 to 8 V in the 0 to 50% position and 8 to 10 V in the 50% to 100% position with a span of 0 to 10 V, set the boundary position to 50% and the boundary value to 8.00 V.

<Related Topics> Enabling the partial expanded recording function: Section 7.13

6.6 Turning Trend Recording (Dot Model) and Periodic Printout ON/OFF for Each Channel

This section explains the details of setting the trend recording and periodic printout for each measurement channel.

The following settings can be entered for each channel.

- Turn trend recording ON/OFF (dot model only).
- Turn the printing of measured values ON/OFF during periodic printout.

Procedure

1. Hold down the **MENU** key for 3 seconds to enter Setting mode.
2. Press the $\nabla\Delta$ key or **SHIFT + $\nabla\Delta$** key to select **Aux** and then press the \leftarrow key.
3. Press the $\nabla\Delta$ key or **SHIFT + $\nabla\Delta$** key to select **Print out** and then press the \leftarrow key.
4. Set each item and press the \leftarrow key.
Use the $\nabla\Delta$ key or **SHIFT + $\nabla\Delta$** key to select values.
For the procedure on how to enter values or characters, see section 4.2.
If you press the **ESC** key in the middle of the operation, the settings entered up to then are cancelled, and the display returns to a higher level menu.
5. When the **Setting complete** screen appears, do either of the following:
Press the \leftarrow key to set other channels.
If you are done, press the **ESC** key.
6. Hold down the **MENU** key for 3 seconds to return to Operation mode.

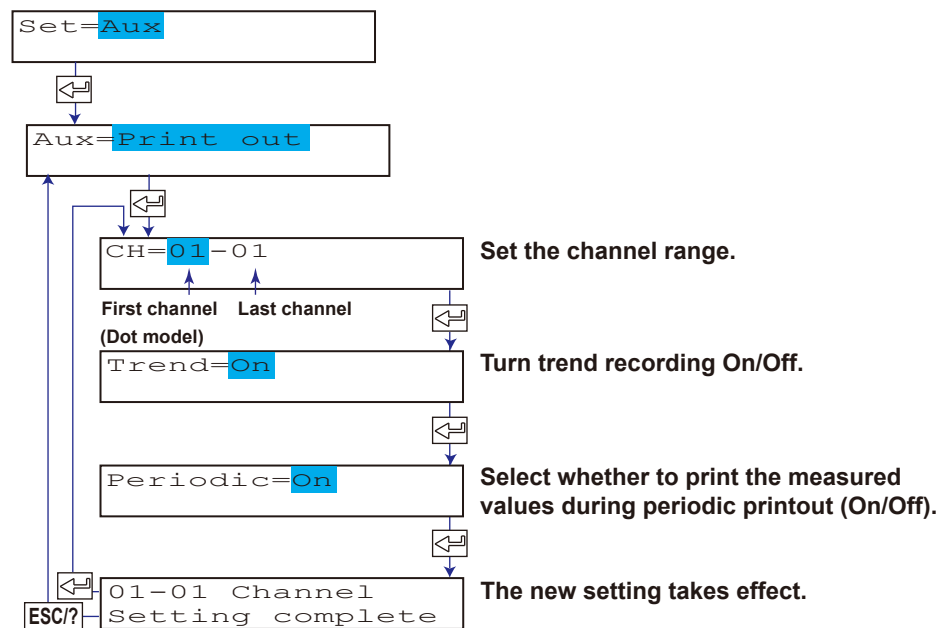

Explanation

Trend Recording (Dot Model)

On: Turns On the trend recording of the specified channel.

Periodic Printout

On: Prints the measured values (instantaneous values or report data) of the specified channel during periodic printout.

Off: Does not print the channels and measured values during periodic printout.

6.7 Setting Tags on Channels

This section explains the details of setting tags to measurement channels.

Procedure

1. Hold down the **MENU** key for 3 seconds to enter Setting mode.
2. Press the $\nabla\Delta$ key or **SHIFT** + $\nabla\Delta$ key to select **Aux** and then press the \leftarrow key.
3. Press the $\nabla\Delta$ key or **SHIFT** + $\nabla\Delta$ key to select **Tag** and then press the \leftarrow key.
4. Set each item and press the \leftarrow key.
Use the $\nabla\Delta$ key or **SHIFT** + $\nabla\Delta$ key to select values.
For the procedure on how to enter values or characters, see section 4.2.
If you press the **ESC** key in the middle of the operation, the settings entered up to then are cancelled, and the display returns to a higher level menu.
5. When the **Setting complete** screen appears, do either of the following:
Press the \leftarrow key to set other channels.
If you are done, press the **ESC** key.
6. Hold down the **MENU** key for 3 seconds to return to Operation mode.

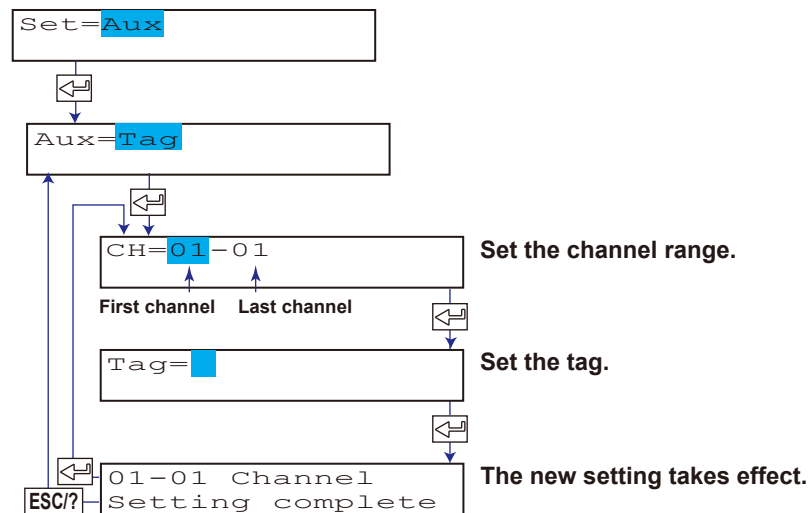

Explanation

Characters That Can Be Used for Tags

Set the tag using up to 7 characters.

The available characters are as follows:

Alphabet, numbers, symbols (% , # , ° , @ , + , - , * , / , (,) , μ , Ω , ² , ³ , .), and space

<Related Topics> Printing tags in place of channel numbers: Section 7.7
Displaying tags in place of channel numbers: Section 8.2

6.8 Setting the Message String

This section explains the details of setting the message strings to be printed on the chart paper. Up to five message strings can be registered.

Procedure

1. Hold down the **MENU** key for 3 seconds to enter Setting mode.
2. Press the **▽△** key or **SHIFT + ▽△** key to select **Aux** and then press the **↵** key.
3. Press the **▽△** key or **SHIFT + ▽△** key to select **Message** and then press the **↵** key.
4. Set each item and press the **↵** key.
Use the **▽△** key or **SHIFT + ▽△** key to select values.
For the procedure on how to enter values or characters, see section 4.2.
If you press the **ESC** key in the middle of the operation, the settings entered up to then are cancelled, and the display returns to a higher level menu.
5. When the **Setting complete** screen appears, do either of the following:
To correct the setting, press the **↵** key.
If you are done, press the **ESC** key.
6. Hold down the **MENU** key for 3 seconds to return to Operation mode.

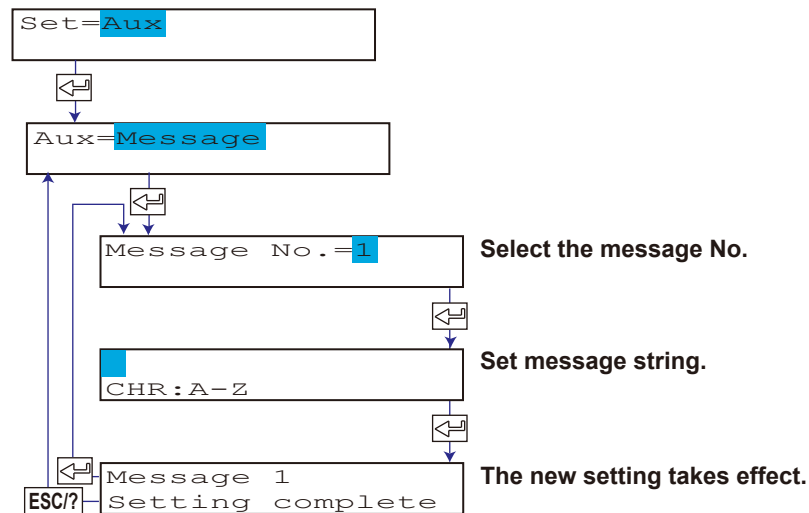

Explanation

Characters That Can Be Used for Messages

Set the message using up to 16 characters.

The available characters are as follows:

Alphabet, numbers, symbols (% , # , ° , @ , + , - , * , / , (,) , μ , Ω , ² , ³ , .), and space

<Related Topics> Printing messages: Section 3.10

6.9 Setting the Secondary Chart Speed (Remote Control Function, /R1)

This section explains the details of setting the secondary chart speed when the chart speed is to be switched using the remote control function (/R1 option).

Procedure

1. Hold down the **MENU** key for 3 seconds to enter Setting mode.
2. Press the $\nabla\Delta$ key or **SHIFT** + $\nabla\Delta$ key to select **Aux** and then press the \leftarrow key.
3. Press the $\nabla\Delta$ key or **SHIFT** + $\nabla\Delta$ key to select **Chart2** and then press the \leftarrow key.
4. Set each item and press the \leftarrow key.
Use the $\nabla\Delta$ key or **SHIFT** + $\nabla\Delta$ key to select values.
For the procedure on how to enter values or characters, see section 4.2.
If you press the **ESC** key in the middle of the operation, the settings entered up to then are cancelled, and the display returns to a higher level menu.
5. When the **Setting complete** screen appears, do either of the following:
To correct the setting, press the \leftarrow key.
If you are done, press the **ESC** key.
6. Hold down the **MENU** key for 3 seconds to return to Operation mode.

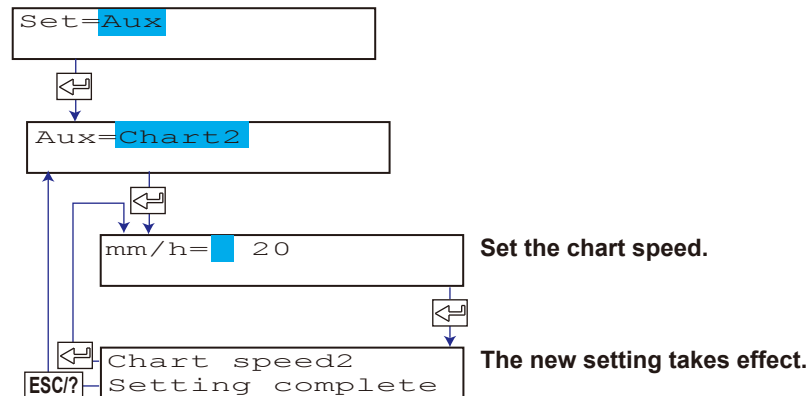

Explanation

Chart Speed

See section 5.4.

<Related Topics> Setting the remote control function: Section 7.18

6.10 Setting the Alarm Delay Duration

This section explains the details of setting the duration of the delay alarm.

Procedure

1. Hold down the **MENU** key for 3 seconds to enter Setting mode.
2. Press the **▽△** key or **SHIFT + ▽△** key to select **Aux** and then press the **↵** key.
3. Press the **▽△** key or **SHIFT + ▽△** key to select **Alm delay T** and then press the **↵** key.
4. Set each item and press the **↵** key.
Use the **▽△** key or **SHIFT + ▽△** key to select values.
For the procedure on how to enter values or characters, see section 4.2.
If you press the **ESC** key in the middle of the operation, the settings entered up to then are cancelled, and the display returns to a higher level menu.
5. When the **Setting complete** screen appears, do either of the following:
Press the **↵** key to set other channels.
If you are done, press the **ESC** key.
6. Hold down the **MENU** key for 3 seconds to return to Operation mode.

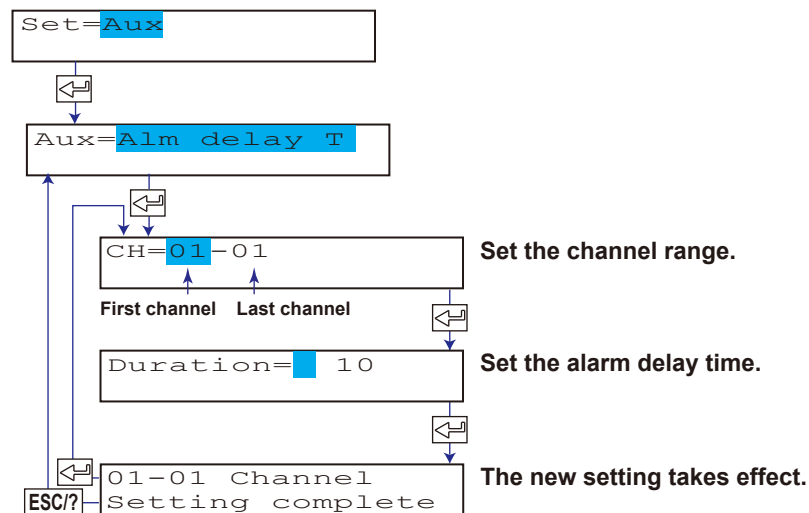

Explanation

Duration

The duration can be set to a value in the range of 1 to 3600 s.

However, if the scan interval on the dot model is 2.5 s, the actual duration is an integer multiple of 2.5 s. If the set value is not equal to an integer multiple of 2.5 s, the duration is the smallest integer multiple of 2.5 s greater than the set value.

Example: The actual duration for 1 s and 2 s is 2.5 s.

<Related Topics> Enabling the alarm delay function: Section 7.15

6.11 Setting the Brightness of the Display and Internal Light

This section explains the details of setting the brightness of the display and the internal light.

Procedure

1. Hold down the **MENU** key for 3 seconds to enter Setting mode.
2. Press the **▽△** key or **SHIFT + ▽△** key to select **Aux** and then press the **↵** key.
3. Press the **▽△** key or **SHIFT + ▽△** key to select **Brightness** and then press the **↵** key.
4. Set each item and press the **↵** key.
Use the **▽△** key or **SHIFT + ▽△** key to select values.
For the procedure on how to enter values or characters, see section 4.2.
If you press the **ESC** key in the middle of the operation, the settings entered up to then are cancelled, and the display returns to a higher level menu.
5. When the **Setting complete** screen appears, do either of the following:
To correct the setting, press the **↵** key.
If you are done, press the **ESC** key.
6. Hold down the **MENU** key for 3 seconds to return to Operation mode.

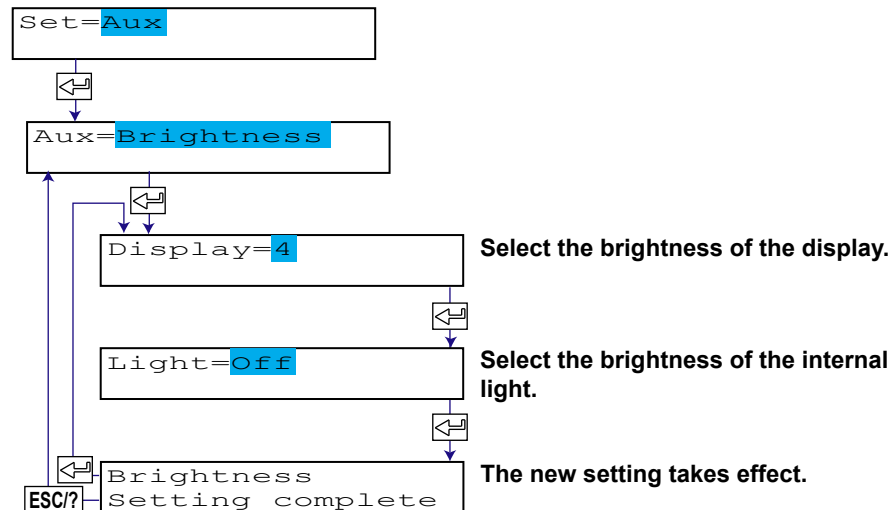

Explanation

Display Brightness

The brightness can be set to an integer between 1 and 8. The darkest setting is 1; the brightest setting is 8.

Internal Light Brightness

The brightness of the internal light can be set to an integer between 1 and 4. The darkest setting is 1; the brightest setting is 4. Select Off to turn Off the internal light.

6.12 Applying a Bias on the Measuring Input Signal

This section explains the details of setting a bias on the measuring input signal. If you change the input range, set the bias again.

Procedure

1. Hold down the **MENU** key for 3 seconds to enter Setting mode.
2. Press the **▽△** key or **SHIFT + ▽△** key to select **Bias** and then press the **↵** key.
3. Set each item and press the **↵** key.
Use the **▽△** key or **SHIFT + ▽△** key to select values.
For the procedure on how to enter values or characters, see section 4.2.
If you press the **ESC** key in the middle of the operation, the settings entered up to then are cancelled, and the display returns to a higher level menu.
4. When the **Setting complete** screen appears, do either of the following:
Press the **↵** key to set other channels.
If you are done, press the **ESC** key.
5. Hold down the **MENU** key for 3 seconds to return to Operation mode.

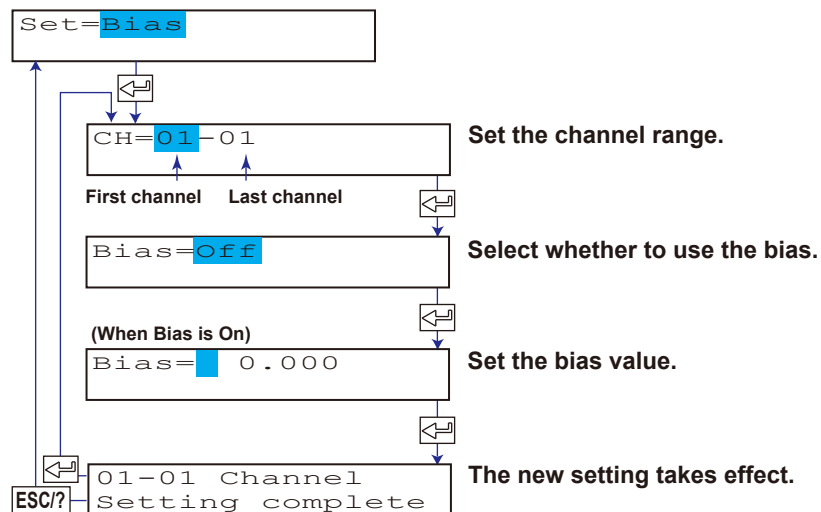

Explanation

Channel Range

The only case when a bias can be set on multiple channels simultaneously is when the channels are set to the same range type (for example channel 01 and 02 are set to 2 V range). For channels on which scaling is set, the channels must be set to the same range type, same span values, and same scaling values.

Bias

The range of bias that can be specified is $\pm 10\%$ of the span of the measurable range at the specified range type. For example, the range is -0.4 V to 0.4 V for the range type 2 V. For channels on which scaling is set, the range is $\pm 10\%$ of the scaling span.

Note

A bias cannot be set on channels set to ON/OFF input (DI).

<Related Topics> Enabling the bias function: Section 7.15

6.13 Performing Calibration Correction (/CC1 Option)

The values of the measuring input signal are corrected using specified segments, and the results are used as measured values.

If you change the input range, set the correction point (measured value) and correction values again.

Procedure

1. Hold down the **MENU** key for 3 seconds to enter Setting mode.
2. Press the **▽△** key or **SHIFT + ▽△** key to select **Calibration** and then press the **↵** key.
3. Set each item and press the **↵** key.
Use the **▽△** key or **SHIFT + ▽△** key to select values.
For the procedure on how to enter values or characters, see section 4.2.
If you press the **ESC** key in the middle of the operation, the settings entered up to then are cancelled, and the display returns to a higher level menu.
4. When the **Setting complete** screen appears, do either of the following:
Press the **↵** key to set other channels.
If you are done, press the **ESC** key.
5. Hold down the **MENU** key for 3 seconds to return to Operation mode.

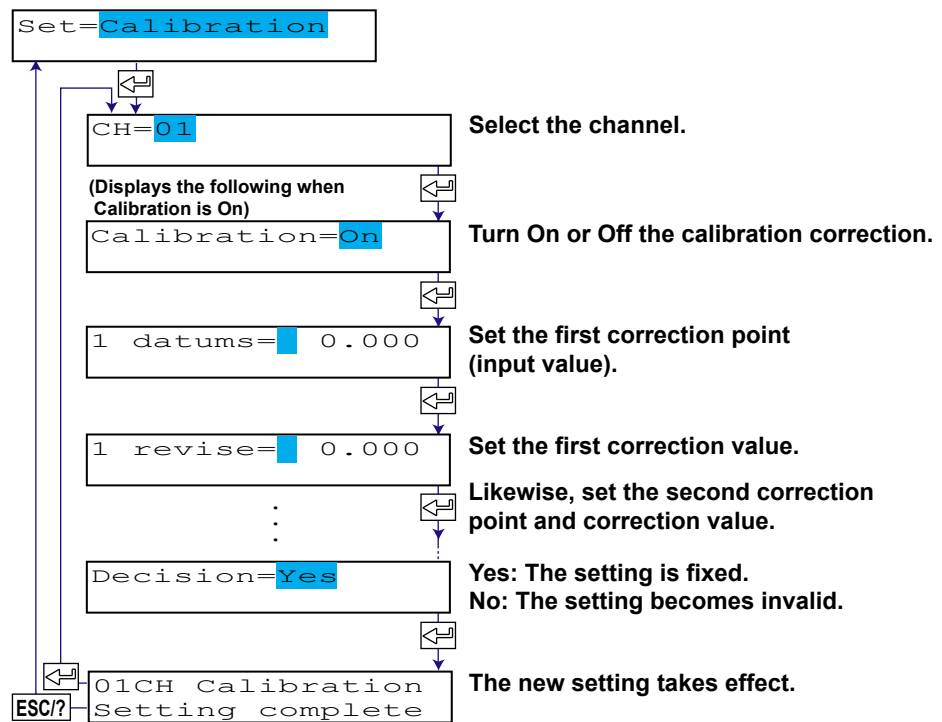

Explanation

Setting Correction Points (Measured Values) and Correction Values

- Using revise values

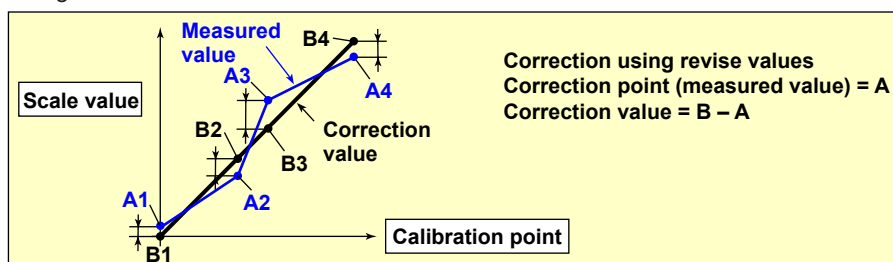

- Using absolute values

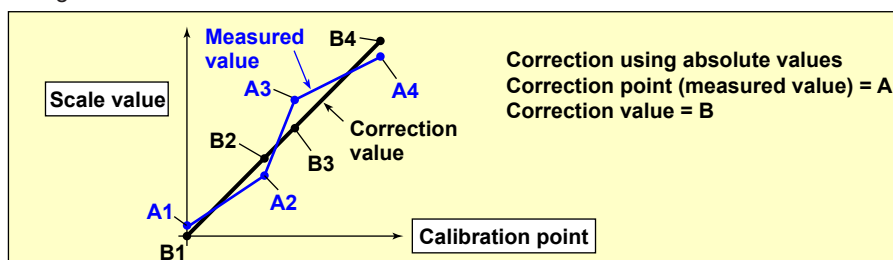

Example of a two-point correction

Calibration Point	Corrected Value	Measured value (A)	Correction Value	
			Revise Value (B - A)	Absolute Value (B)
1	10.0°C	9.8°C	0.2°C	10.0°C
2	90.0°C	90.5°C	-0.5°C	90.0°C

Setup Conditions of Measured and Correction Values

- Setting range of measured and correction values when using revise values

$$A1 < A2 \leq A3 \leq \dots \leq A16$$

$$(A1 + B1) < (A2 + B2) < (A3 + B3) < \dots < (A16 + B16)$$

A and B are within the measurable range or scaling range of the range type*

* Within the scaling range: -5% to 105% of the scale value or -20000 to 30000 (the decimal place is the same as the setting for the scale value)

- Setting range of measured and correction values when using absolute values

$$A1 < A2 \leq A3 \leq \dots \leq A16$$

$$B1 < B2 < B3 < \dots < B16$$

A and B are within the measurable range or scaling range of the range type*

* Within the scaling range: -5% to 105% of the scale value or -20000 to 30000 (the decimal place is the same as the setting for the scale value)

Note

- Make sure that the leftmost value is less than the rightmost value for span and scale.
- Calibration correction cannot be set on ON/OFF input (DI), delta computation, and square root computation channels. In addition, calibration correction cannot be used on all channels if the bias function is enabled.

<Related Topics> Enabling the calibration correction function: Section 7.15
Setting the calibration correction function: Section 7.23

6.14 Setting Up Start Printout and End printout (/BT1 Option)

Enter settings for Start printout/Start printout 2 when starting recording, and for End printout/End printout 2 when stopping recording.

You cannot enter Basic Setting mode during the time between start printout to end printout.

Procedure

1. Hold down the **MENU** key for 3 seconds to enter Setting mode.
2. Press the **▽△** key or **SHIFT + ▽△** key to select **Batch** and then press the **↵** key.
3. Set each item and press the **↵** key.
Use the **▽△** key or **SHIFT + ▽△** key to select values.
For the procedure on how to enter values or characters, see section 4.2.
If you press the **ESC** key in the middle of the operation, the settings entered up to then are cancelled, and the display returns to a higher level menu.
4. When the **Setting complete** screen appears, do either of the following:
To correct the setting the **↵** key.
If you are done, press the **ESC** key.
5. Hold down the **MENU** key for 3 seconds to return to Operation mode.

Setting the Batch Number

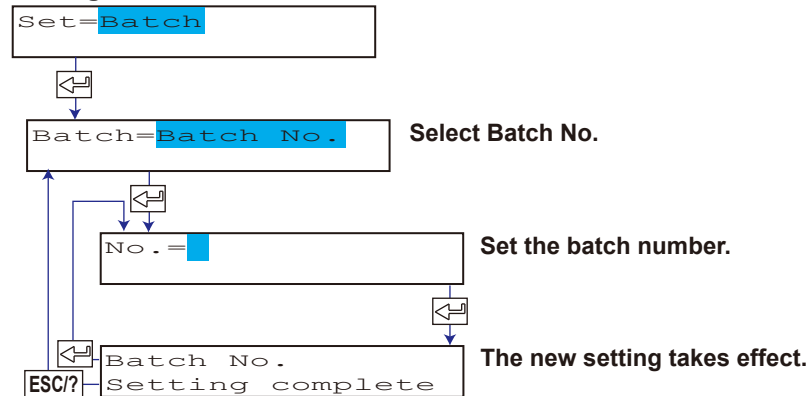

Setting the Lot Number

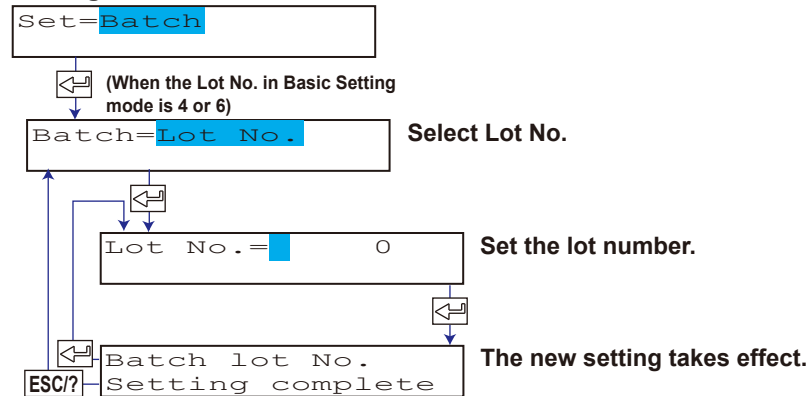

Setting Comments

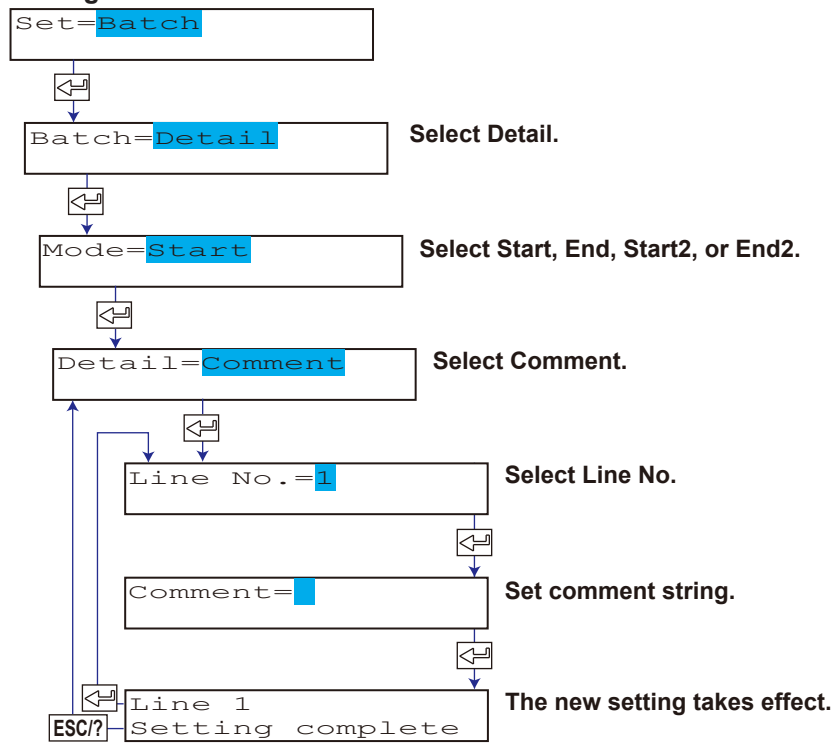

Selecting Printout On/Off for the Batch Name, Chart Speed, and Date/Time.

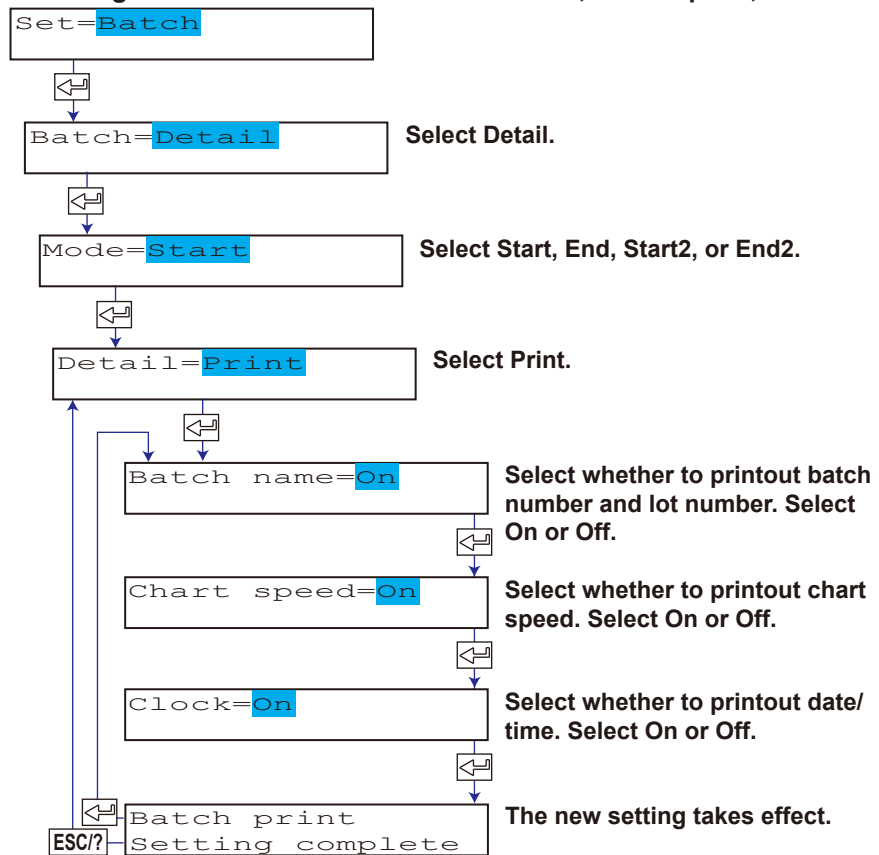

Setting the Feed Amount, Lot Number Update, and Ejection of Pen Offset Compensating Data

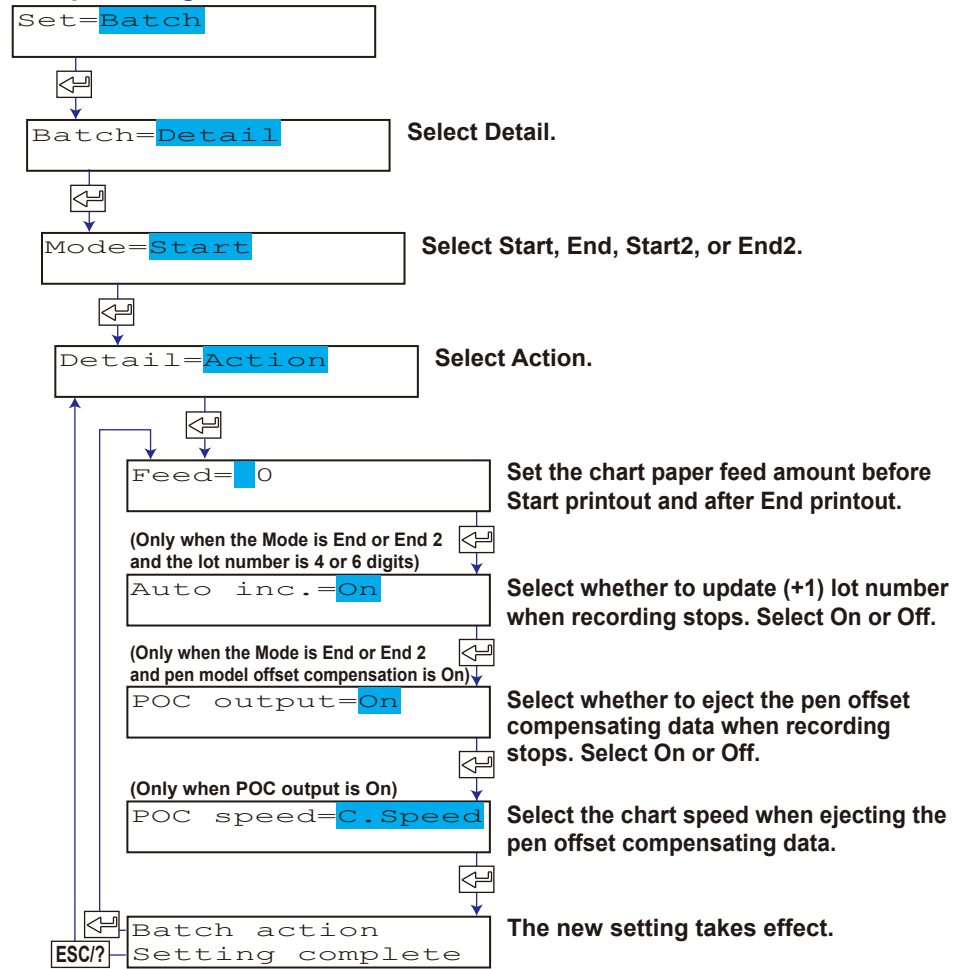

Explanation

Batch No.

You can enter up to 26 characters.
 The following are the characters that can be used.
 Alphabet, numbers, symbols (% , # , ° , @ , + , - , * , / , (,) , μ , Ω , ² , ³ , .), and space

Lot No.

Enter using a 4 or 6 digit number. Select which number of digits to use (4 or 6) under "Lot No." in Basic Setting mode.

Mode

Select Start, End, Start 2, or End 2. Start 2 and End 2 become available when you enable "Dual comment" in Basic Setting mode.

Line No.

1 to 5 lines can be printed out.

Comment

You can enter up to 32 characters.
 The following are the characters that can be used.
 Alphabet, numbers, symbols (% , # , ° , @ , + , - , * , / , (,) , μ , Ω , ² , ³ , .), and space

Feed

The available setting range is 0 to 50 mm.

POC output

You can eject the portion that is not recorded when recording stops with the pen offset compensating recording function.

POC speed

Select the chart speed when ejecting the portion that was not recorded.

Chart speed: Feeds at the specified chart speed.

450mm/h: Fixed to feed at 450 mm/h.

Note

The following operations are performed when using the header printout function (/BT1 option).

- **When the power is interrupted and is reintroduced, recording always stops. End printout/End printout 2 is not performed.**
 - **When recording stop detection is performed (option /F1), recording and printout stop.**
When chart paper is inserted, the instrument operates as follows.
 - When detected during Start printout and recording: Recording starts after Start printout.
 - When detected during End printout: When stopped, End printout/End printout 2 is not performed.
 - Until Start printout/Start printout 2 and End printout/End printout 2 finishes, the instrument cannot transition to the next operation.
 - When recording is started, the alarm and message printout information stored in the buffer prior to recording stop is cleared.
-

<Related Topics> Enabling the batch function: Section 7.24
Setting the number of digits of the lot number and enabling start printout 2 and end printout 2: Section 7.24

6.15 Setting the Message Format (/BT1 Option)

In the 5 message printouts, up to 35 characters can be printed out including the date/time and measured values.*

- Under Message format, you can specify the printout contents of date/time, message string, measured values,* and the order of these.
- Messages including measured values* can be printed out even when Start printout or End printout is disabled.
- For entering message strings, see section 6.8.

* Computed values can also be included on models with the /M1 option.

Procedure

1. Hold down the **MENU** key for 3 seconds to enter Setting mode.
2. Press the **▽△** key or **SHIFT + ▽△** key to select **Batch** and then press the **↵** key.
3. Press the **▽△** key or **SHIFT + ▽△** key to select **MSG format** and then press the **↵** key.
4. Set each item and press the **↵** key.
Use the **▽△** key or **SHIFT + ▽△** key to select values.
For the procedure on how to enter values or characters, see section 4.2.
If you press the **ESC** key in the middle of the operation, the settings entered up to then are cancelled, and the display returns to a higher level menu.
5. When the **Setting complete** screen appears, do either of the following:
To correct the setting the **↵** key.
If you are done, press the **ESC** key.
6. Hold down the **MENU** key for 3 seconds to return to Operation mode.

Entering message format

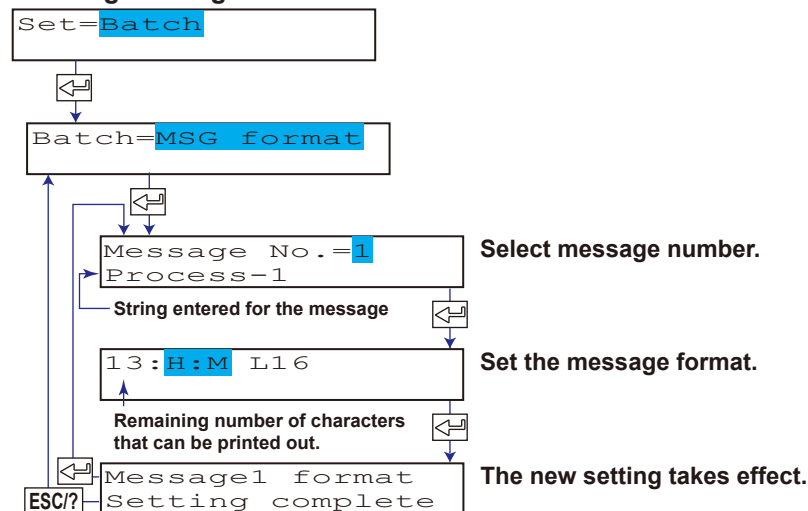

Explanation

Message No.

Select from 1 to 5.

MSG format

Choose a message format. Measured values,* message strings, and date/time can be set arbitrarily.

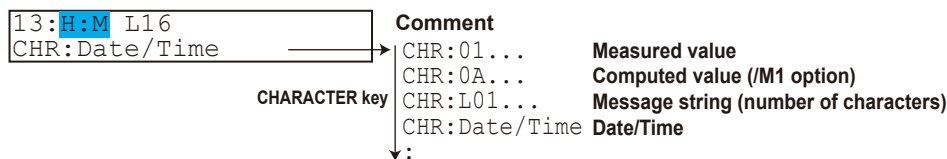

Example: Based on the message 1 string of the standard function, you can set a combination with message format 1 and print it out as message 1 including measured values.*

Standard function

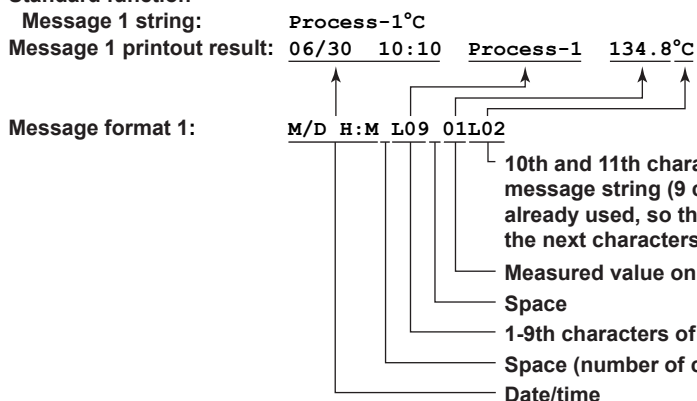

* Computed values can also be included on models with the /M1 option.

• **Date/Time Format and Number of Characters Used**

H:M	(Hour:Minute)	5 characters
H:M:S	(Hour:Minute:Second)	8 characters
M/D H:M	(Month/Day Hour:Minute)	11 characters
M/D H:M:S	(Month/Day Hour:Minute:Second)	14 characters
D/M H:M	(Day/Month Hour:Minute)	11 characters
D/M H:M:S	(Day/Month Hour:Minute:Second)	14 characters
D.M H:M	(Day.Month Hour:Minute)	11 characters
D.M H:M:S	(Day.Month Hour:Minute:Second)	14 characters
M.D H:M	(Month.Day Hour:Minute)	12 characters
M.D H:M:S	(Month.Day Hour:Minute:Second)	15 characters
Y/M/D H:M:S	(Year/Month/Day Hour:Minute:Second)	19 characters
M/D/Y H:M:S	(Month/Day/Year Hour:Minute:Second)	19 characters
D/M/Y H:M:S	(Day/Month/Year Hour:Minute:Second)	19 characters
D.M.Y H:M:S	(Day.Month.Year Hour:Minute:Second)	19 characters
M.D.Y H:M:S	(Month.Day.Year Hour:Minute:Second)	20 characters

• **Format of Measured Values and Computed Values, and Number of Characters Used**

- The format for measured values is 01, 02, ...06 (depending on the model). No units are added. 7 characters are used.
- The format for computed (/M1 option) values is: 0A, 0B, 0C, 0D, 0E, 0F, 0G, 0J, 0K, 0M, 0N, and 0P (depending on the model). No units are added. 9 characters are used.

• **Character String Format**

The format for message strings is L01 (1 character), L02 (2 characters), L16 (16 characters).
In the example above, L09 specifies "Process-1" and L02 specifies "°C ."

<Related Topics> Enabling the message format: Section 7.24

6.16 Setting the Date/Time When Switching between Standard Time and DST

This section explains the details of setting the date/time when switching from the standard time to DST and the date/time when switching back from DST to standard time if the recorder is used in a region that has DST. When the preset date/time arrives, the recorder internal clock automatically switches.

Procedure

1. Hold down the **MENU** key for 3 seconds to enter Setting mode.
2. Press the **▽△** key or **SHIFT + ▽△** key to select **Aux** and then press the **↵** key.
3. Press the **▽△** key or **SHIFT + ▽△** key to select **DST** and then press the **↵** key.
4. Set each item and press the **↵** key.
Press the **▽△** key or **SHIFT + ▽△** key to select values.
For the procedure on how to enter values or characters, see section 4.2.
If you press the **ESC** key in the middle of the operation, the settings entered up to then are cancelled, and the display returns to a higher level menu.
5. When the **Setting complete** screen appears, do either of the following:
Press the **↵** key to set other channels.
If you are done, press the **ESC** key.
6. Hold down the **MENU** key for 3 seconds to return to Operation mode.

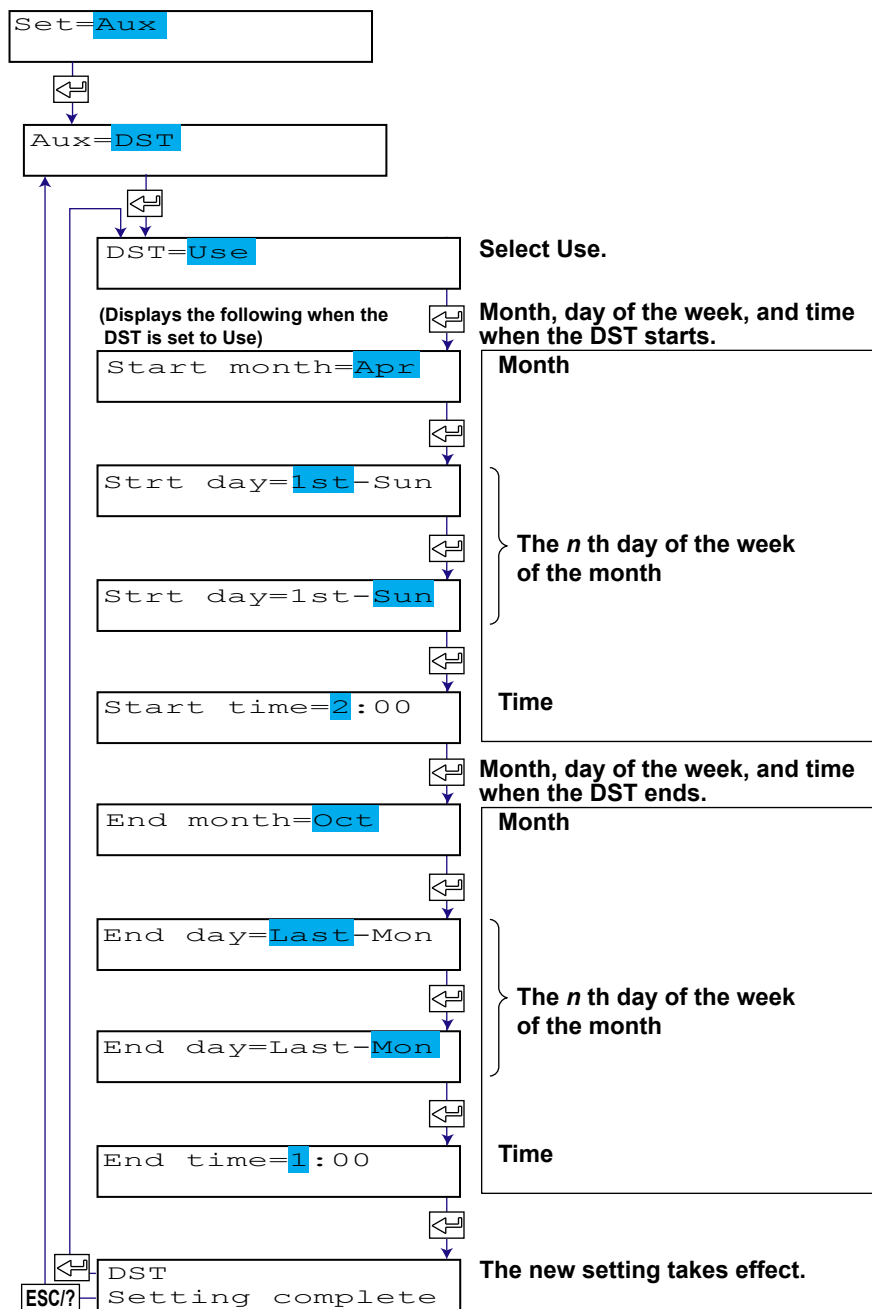

Explanation

DST
Select Use to use DST.

Start month, Strt day, and Start time
Set the date/time for switching from standard time to DST. Specify the day as the *n*th day of the week of the month.

End month, End day, and End time
Set the date/time for switching from DST to standard time. Specify the day as the *n*th day of the week of the month.

6.16 Setting the Date/Time When Switching between Standard Time and DST

Recorders with Version 1.02 or Earlier

The following is the setting menu.

Time=Summer

Select standard time (Winter) or DST (Summer).

Summer=Off

Select On to set the time to switch between standard time and DST.

Time=04/07/05 00

Set the time to switch.

DST
Setting complete

The new setting takes effect.

7.1 Changing the Auxiliary Alarm Function

This section explains the details of setting the alarm system items listed below.

- Diagnosis output using the alarm output relay (I01)
- Reflash alarm operation of the alarm output relay (I01 to I03)
- AND/OR operation of alarm output relays
- Energized/De-energized operation of alarm output relays when alarms occur
- Hold/Non-hold operation of alarm output relays
- Hold/Non-hold operation of alarm indications
- The interval of the rate-of-change alarm
- Alarm hysteresis

Basic Setting mode cannot be entered when recording is in progress or when computation is in progress on models with the computation function (/M1 option).

Procedure

Changing the Settings

1. Hold down the **MENU** key for 3 seconds to enter Setting mode.
2. Hold down the **▽△** and **◀▶** keys simultaneously for 3 seconds to enter Basic Setting mode.
3. Press the **↵** key with **Alarm** shown on the screen.
4. Set each item and press the **↵** key.
Use the **▽△** key or **SHIFT + ▽△** key to select values.
For the procedure on how to enter values or characters, see section 4.2.
If you press the **ESC** key in the middle of the operation, the settings entered up to then are cancelled, and the display returns to a higher level menu.
5. When the **Setting complete** screen appears, do either of the following:
To correct the setting, press the **↵** key.
If you are done, press the **ESC** key.

7.1 Changing the Auxiliary Alarm Function

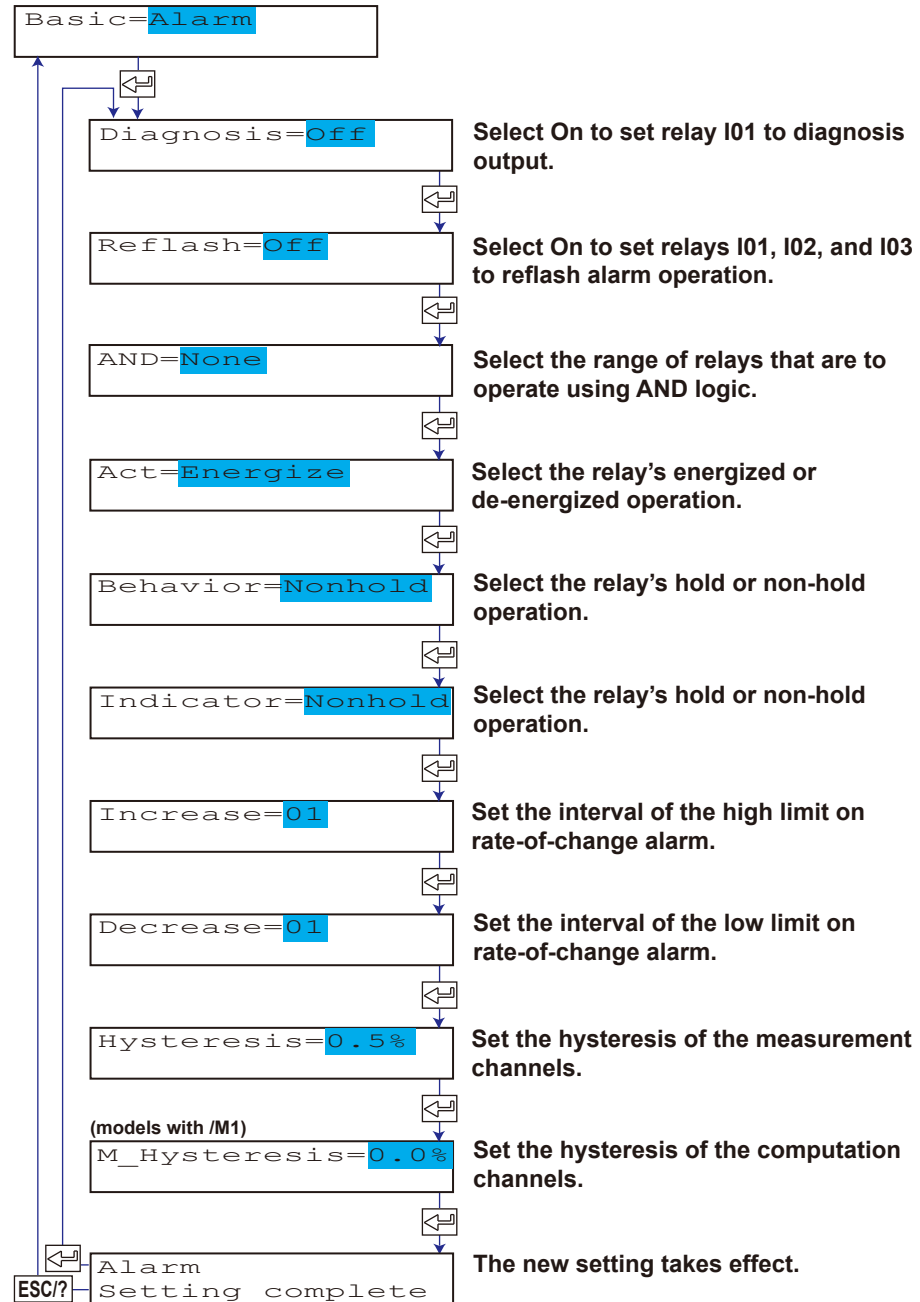

Applying the Changes and Returning to Operation Mode

Press the $\nabla\Delta$ key or **SHIFT** + $\nabla\Delta$ key to select **End** and then press the \leftarrow key. Press the $\nabla\Delta$ key to select **Store** and then press the \leftarrow key. The changes are applied, and the screen returns to Operation mode. If you select **Abort** and press the \leftarrow key, the changes are discarded, and the screen returns to Operation mode. Press the **ESC** key to return to the **Basic=** screen.

Explanation

Diagnosis

When set to On, alarm output relay I01 becomes a dedicated diagnosis output relay, and the operation is fixed to OR, de-energized, and non-hold. Diagnosis output is a function which outputs a relay signal when there is an error in the plotter operation on the pen model, when a burnout is detected, or when there is an error in the A/D converter.

Reflash

Turns On/Off the reflash alarm operation of alarm output relays I01, I02, and I03. When set to On, alarm output relays I01, I02, and I03 set to reflash alarm operation, and the operation is fixed to OR, de-energized, and non-hold.

AND

Sets the AND/OR operation of alarm output relays.

None: No relays are set to AND operation. All relays are set to OR operation.

I01: Only I01 is set to AND operation.

I01-I02: I01 and I02 are set to AND operation.

I01-I03: I01 to I03 are set to AND operation.

I01-I04: I01 to I04 are set to AND operation.

I01-I05: I01 to I05 are set to AND operation.

I01-I06: I01 to I06 are set to AND operation.

Act

Sets whether the output relay is energized or de-energized when an alarm occurs.

Energize: Energizes the relay when an alarm occurs. The relay is de-energized during normal operation.

De_energize: De-energizes the relay when an alarm occurs. The relay is energized during normal operation.

Behavior

Specifies whether to set the alarm output relay to hold operation or non-hold operation.

Nonhold: Releases the relay output at the same time the alarm is released.

Hold: Holds the relay output until the alarm ACK operation is executed.

Indicator

Specifies whether to set the alarm indication to hold operation or non-hold operation.

Nonhold: Releases the alarm indication at the same time the alarm is released.

Hold: Holds the alarm indication until the alarm ACK operation is executed.

Increase

Set the interval of the high limit on rate-of-change alarm to an integer between 1 and 15. The interval is set to scan interval \times (1 to 15).

Pen model: The scan interval is 125 ms. The maximum interval is 1.875 s.

Dot model: The maximum interval when the scan interval set to 1 s is 15 s. The maximum interval when the scan interval set to 2.5 s is 37.5 s.

Decrease

Set the interval of the low limit on rate-of-change alarm to an integer between 1 and 15. The setup procedure is the same as Increase.

Hysteresis

Sets the alarm hysteresis of the measurement channels.

The hysteresis width can be set in the range of 0.0% (Off) to 1.0% of the recording span in 0.1 steps.

The hysteresis applies to all high limit and low limit alarms of measurement channels.

M_Hysteresis (Models with the Computation Function (/M1 Option))

Sets the alarm hysteresis of the computation channels.

The hysteresis width can be set in the range of 0.0% (Off) to 1.0% of the recording span in 0.1 steps.

The hysteresis applies to all high limit and low limit alarms of computation channels.

7.2 Changing the Integration Time of the A/D Converter

This section explains the details of setting the integration time of the A/D converter. Basic Setting mode cannot be entered when recording is in progress or when computation is in progress on models with the computation function (/M1 option).

Procedure

Changing the Settings

1. Hold down the **MENU** key for 3 seconds to enter Setting mode.
2. Hold down the **▽△** and **◀▶** keys simultaneously for 3 seconds to enter Basic Setting mode.
3. Press the **▽△** key or **SHIFT + ▽△** key to select **A/D** and then press the **↵** key.
4. Set each item and press the **↵** key.
Use the **▽△** key or **SHIFT + ▽△** key to select values.
For the procedure on how to enter values or characters, see section 4.2.
If you press the **ESC** key in the middle of the operation, the settings entered up to then are cancelled, and the display returns to a higher level menu.
5. When the **Setting complete** screen appears, do either of the following:
To correct the setting, press the **↵** key.
If you are done, press the **ESC** key.

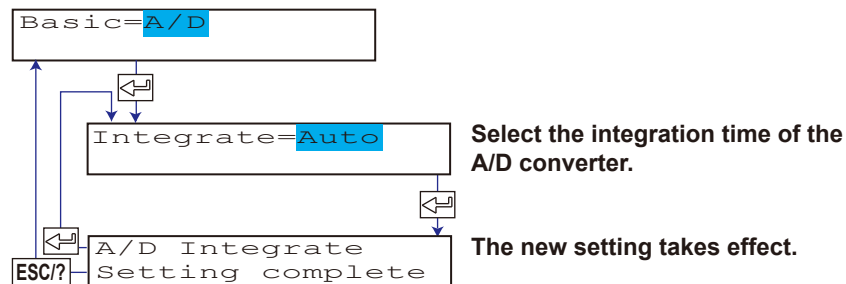

Applying the Changes and Returning to Operation Mode

Press the **▽△** key or **SHIFT + ▽△** key to select **End** and then press the **↵** key. Press the **▽△** key to select **Store** and then press the **↵** key. The changes are applied, and the screen returns to Operation mode. If you select **Abort** and press the **↵** key, the changes are discarded, and the screen returns to Operation mode. Press the **ESC** key to return to the **Basic=** screen.

Explanation

Integrate

Selects the integration time of the A/D converter.

Setting	Integration Time	Scan Interval (Pen Model)	Scan Interval (Dot Model)
50 Hz	20 ms	125 ms	1 s
60 Hz	16.7 ms	125 ms	1 s
Auto	20 ms or 16.7ms ^{2, 3}	125 ms	1 s
100 ms ¹	100 ms	–	2.5 s

1: Selectable only on the dot model.

2: Automatically switch by detecting the power supply frequency.

3: The integration time is fixed to 20 ms if "Auto" is selected when using the DC power supply on a model with the /P1 option.

7.3 Setting the Burnout Detection Function of Thermocouples

This section explains the details of setting the burnout detection function of thermocouples to channels set to 1-5V or TC input.

Basic Setting mode cannot be entered when recording is in progress or when computation is in progress on models with the computation function (/M1 option).

Procedure

Changing the Settings

1. Hold down the **MENU** key for 3 seconds to enter Setting mode.
2. Hold down the **▽△** and **◀▶** keys simultaneously for 3 seconds to enter Basic Setting mode.
3. Press the **▽△** key or **SHIFT + ▽△** key to select **Burnout** and then press the **↵** key.
4. Set each item and press the **↵** key.
Use the **▽△** key or **SHIFT + ▽△** key to select values.
For the procedure on how to enter values or characters, see section 4.2.
If you press the **ESC** key in the middle of the operation, the settings entered up to then are cancelled, and the display returns to a higher level menu.
5. When the **Setting complete** screen appears, do either of the following:
Press the **↵** key to set other channels.
If you are done, press the **ESC** key.

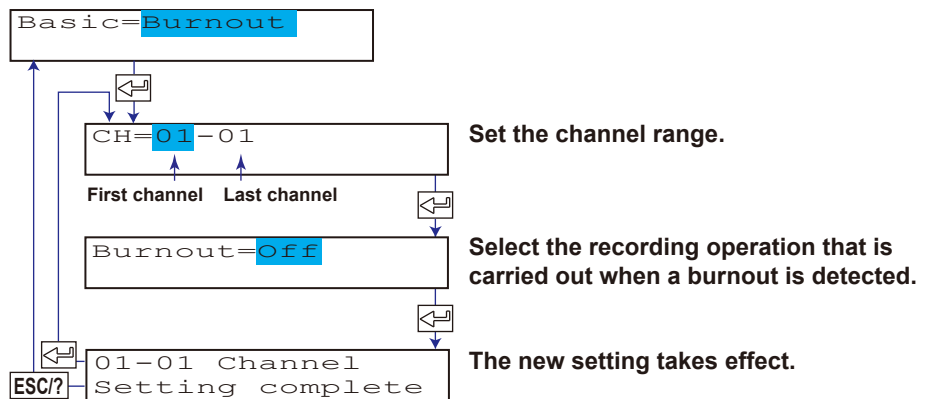

Applying the Changes and Returning to Operation Mode

Press the **▽△** key or **SHIFT + ▽△** key to select **End** and then press the **↵** key. Press the **▽△** key to select **Store** and then press the **↵** key. The changes are applied, and the screen returns to Operation mode. If you select **Abort** and press the **↵** key, the changes are discarded, and the screen returns to Operation mode. Press the **ESC** key to return to the **Basic=** screen.

Explanation

Burnout

Selects the action taken when a burnout is detected at the 1-5V input or the thermocouple input.

Up: Records off the scale on the 100% side.

Down: Records off the scale on the 0% side.

Select Off when not using the burnout detection function.

7.4 Setting the RJC Function on Channels Set to TC Input

This section explains the details of setting RJC on channels set to TC input. Basic Setting mode cannot be entered when recording is in progress or when computation is in progress on models with the computation function (/M1 option).

Procedure

Changing the Settings

1. Hold down the **MENU** key for 3 seconds to enter Setting mode.
2. Hold down the $\nabla\Delta$ and $\triangleleft\triangleright$ keys simultaneously for 3 seconds to enter Basic Setting mode.
3. Press the $\nabla\Delta$ key or **SHIFT** + $\nabla\Delta$ key to select **RJC** and then press the \triangleleft key.
4. Set each item and press the \triangleleft key.
Use the $\nabla\Delta$ key or **SHIFT** + $\nabla\Delta$ key to select values.
For the procedure on how to enter values or characters, see section 4.2.
If you press the **ESC** key in the middle of the operation, the settings entered up to then are cancelled, and the display returns to a higher level menu.
5. When the **Setting complete** screen appears, do either of the following:
Press the \triangleleft key to set other channels.
If you are done, press the **ESC** key.

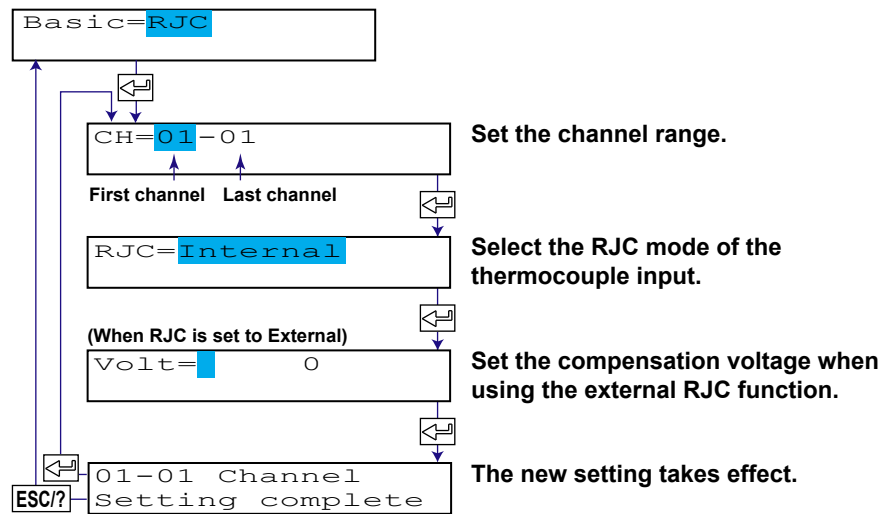

Applying the Changes and Returning to Operation Mode

Press the $\nabla\Delta$ key or **SHIFT** + $\nabla\Delta$ key to select **End** and then press the \triangleleft key. Press the $\nabla\Delta$ key to select **Store** and then press the \triangleleft key. The changes are applied, and the screen returns to Operation mode. If you select **Abort** and press the \triangleleft key, the changes are discarded, and the screen returns to Operation mode. Press the **ESC** key to return to the **Basic=** screen.

Explanation

RJC

Sets the RJC mode.

Internal: Uses the RJC function on the recorder.

External: Uses an external RJC function. If external is selected, set the compensation voltage.

Volt

Sets the compensation voltage when using an external RJC function.

The compensation voltage can be set in the range of $-20000 \mu\text{V}$ to $20000 \mu\text{V}$.

7.5 Changing the Channel Recording Color (Dot Model)

This section explains the details of changing the trend recording color on the dot model. Basic Setting mode cannot be entered when recording is in progress or when computation is in progress on models with the computation function (/M1 option).

Procedure

Changing the Settings

1. Hold down the **MENU** key for 3 seconds to enter Setting mode.
2. Hold down the **▽△** and **◀▶** keys simultaneously for 3 seconds to enter Basic Setting mode.
3. Press the **▽△** key or **SHIFT + ▽△** key to select **Color** and then press the **↵** key.
4. Set each item and press the **↵** key.
Use the **▽△** key or **SHIFT + ▽△** key to select values.
For the procedure on how to enter values or characters, see section 4.2.
If you press the **ESC** key in the middle of the operation, the settings entered up to then are cancelled, and the display returns to a higher level menu.
5. When the **Setting complete** screen appears, do either of the following:
Press the **↵** key to set other channels.
If you are done, press the **ESC** key.

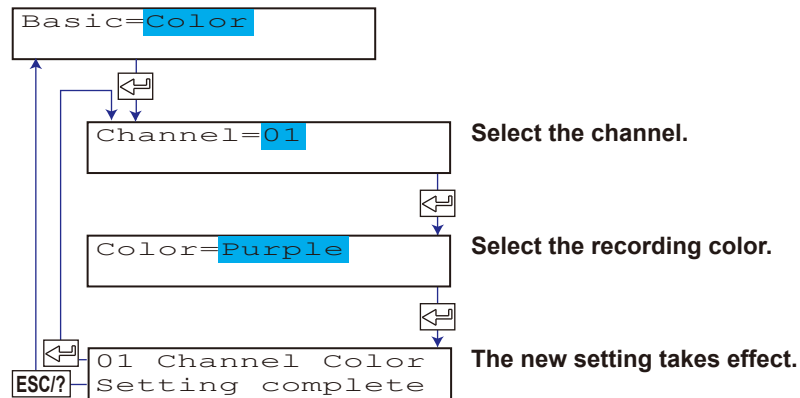

Applying the Changes and Returning to Operation Mode

Press the **▽△** key or **SHIFT + ▽△** key to select **End** and then press the **↵** key. Press the **▽△** key to select **Store** and then press the **↵** key. The changes are applied, and the screen returns to Operation mode. If you select **Abort** and press the **↵** key, the changes are discarded, and the screen returns to Operation mode. Press the **ESC** key to return to the **Basic=** screen.

Explanation

Color

Sets the recording color of measurement channels.

By default, the recording colors are set as follows:

Channel01: Purple

Channel 02: Red

Channel 03: Green

Channel 04: Blue

Channel 05: Brown

Channel 06: Black

7.6 Recording by Compensating for the Pen Offset along the Time Axis (Pen Model)

This section explains the details of setting the compensation for the pen offset along the time axis (pen model).

Basic Setting mode cannot be entered when recording is in progress or when computation is in progress on models with the computation function (/M1 option).

Procedure

Changing the Settings

1. Hold down the **MENU** key for 3 seconds to enter Setting mode.
2. Hold down the **▽△** and **◀▶** keys simultaneously for 3 seconds to enter Basic Setting mode.
3. Press the **▽△** key or **SHIFT + ▽△** key to select **POC** and then press the **↵** key.
4. Set each item and press the **↵** key.
Use the **▽△** key or **SHIFT + ▽△** key to select values.
For the procedure on how to enter values or characters, see section 4.2.
If you press the **ESC** key in the middle of the operation, the settings entered up to then are cancelled, and the display returns to a higher level menu.
5. When the **Setting complete** screen appears, do either of the following:
To correct the setting, press the **↵** key.
If you are done, press the **ESC** key.

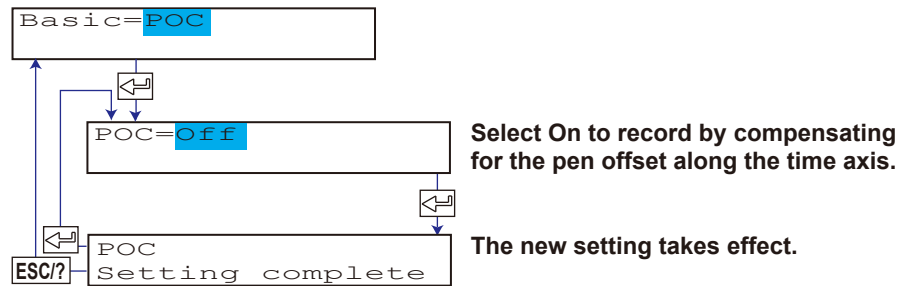

Applying the Changes and Returning to Operation Mode

Press the **▽△** key or **SHIFT + ▽△** key to select **End** and then press the **↵** key. Press the **▽△** key to select **Store** and then press the **↵** key. The changes are applied, and the screen returns to Operation mode. If you select **Abort** and press the **↵** key, the changes are discarded, and the screen returns to Operation mode. Press the **ESC** key to return to the **Basic=** screen.

Explanation

POC (Pen Offset Compensation)

On: Enables pen offset compensation.

Off: Disables pen offset compensation.

Note

When pen offset compensation is enabled, all pens are aligned with the reference pen (pen that is furthest to the back: pen 2 on the 2-pen model, pen 3 on the 3-pen model, and pen 4 on the 4-pen model) for recording. When recording is started, only the reference pen moves until the offset is compensated. This is not a malfunction.

When pen offset compensation is enabled, an asterisk is printed by the time on the periodic printout.

7.7 Turning Printouts ON/OFF

(Selecting the Channel/Tag Printout and Turning ON/OFF the Channel No., Alarm, Recording Start, New Chart Speed, Scale, and Pen Color Printouts)

This section explains the details of turning ON/OFF the printouts of various items. Basic Setting mode cannot be entered when recording is in progress or when computation is in progress on models with the computation function (/M1 option).

Procedure

Changing the Settings

1. Hold down the **MENU** key for 3 seconds to enter Setting mode.
2. Hold down the **▽△** and **◀▶** keys simultaneously for 3 seconds to enter Basic Setting mode.
3. Press the **▽△** key or **SHIFT + ▽△** key to select **Print** and then press the **↵** key.
4. Set each item and press the **↵** key.
Use the **▽△** key or **SHIFT + ▽△** key to select values.
For the procedure on how to enter values or characters, see section 4.2.
If you press the **ESC** key in the middle of the operation, the settings entered up to then are cancelled, and the display returns to a higher level menu.
5. When the **Setting complete** screen appears, do either of the following:
To correct the setting, press the **↵** key.
If you are done, press the **ESC** key.

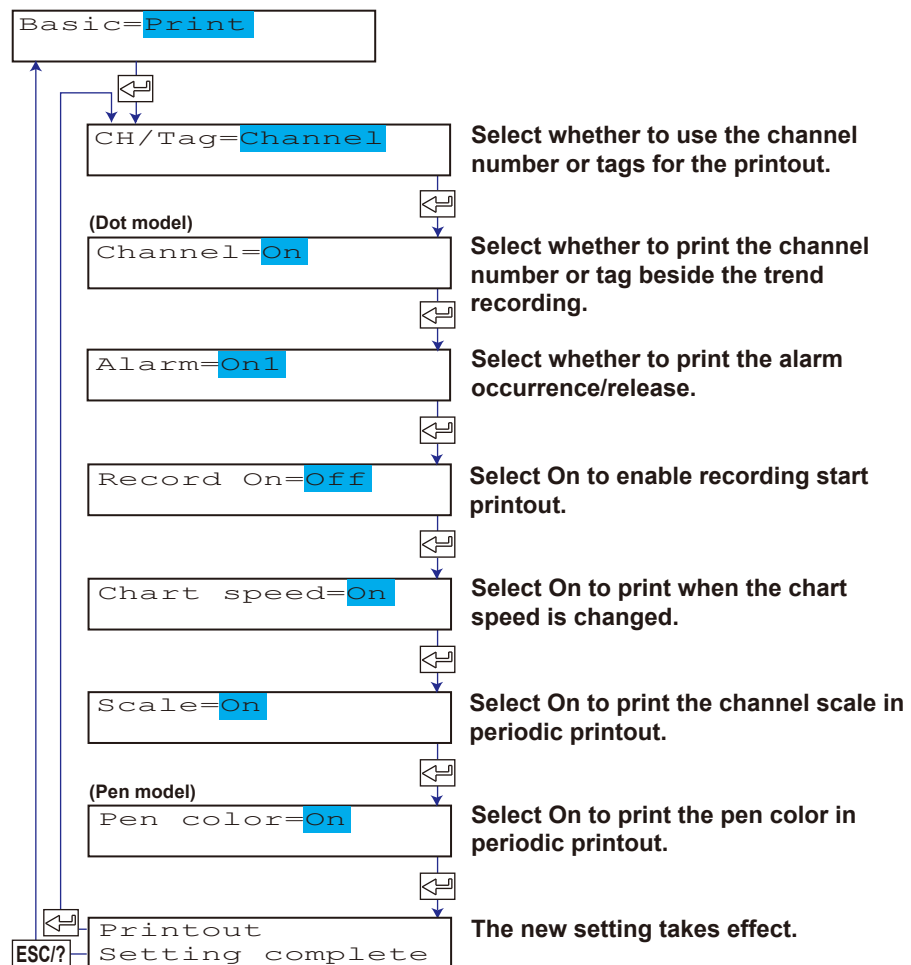

Applying the Changes and Returning to Operation Mode

Press the $\nabla\Delta$ key or **SHIFT** + $\nabla\Delta$ key to select **End** and then press the \leftarrow key. Press the $\nabla\Delta$ key to select **Store** and then press the \leftarrow key. The changes are applied, and the screen returns to Operation mode. If you select **Abort** and press the \leftarrow key, the changes are discarded, and the screen returns to Operation mode. Press the **ESC** key to return to the **Basic=** screen.

Explanation**CH/Tag**

Channel: Prints the channel number.

Tag: Prints the tag.

Channel (Dot Model)

When On is selected channel number or tag is printed by the trend recording.

Alarm

On1: Prints the alarm information when an alarm occurs or releases.

On2: Prints the alarm information only when an alarm occurs.

Off: Does not print alarm information.

Pen Color Printout (Pen Model)

When On is selected, the recording color of the channel whose scale is printed is printed. This is valid when the scale printout is turned On.

Note

Channel, alarm, recording start, and new chart speed printouts are not performed when the chart speed is greater than or equal to 1600 mm/h and 101 mm/h on the pen model and dot model, respectively.

7.8 Setting the Periodic Printout Interval and the Type of Data to Be Printed

This section explains the details of setting the periodic printout interval and the type of data to be printed.

Basic Setting mode cannot be entered when recording is in progress or when computation is in progress on models with the computation function (/M1 option).

Procedure

Periodic Printout Interval and Type of Data to Be Printed Changing the Settings

1. Hold down the **MENU** key for 3 seconds to enter Setting mode.
2. Hold down the **▽△** and **◀▶** keys simultaneously for 3 seconds to enter Basic Setting mode.
3. Press the **▽△** key or **SHIFT + ▽△** key to select **Print1** and then press the **↵** key.
4. Set each item and press the **↵** key.
Use the **▽△** key or **SHIFT + ▽△** key to select values.
For the procedure on how to enter values or characters, see section 4.2.
If you press the **ESC** key in the middle of the operation, the settings entered up to then are cancelled, and the display returns to a higher level menu.
5. When the **Setting complete** screen appears, do either of the following:
To correct the setting, press the **↵** key.
If you are done, press the **ESC** key.

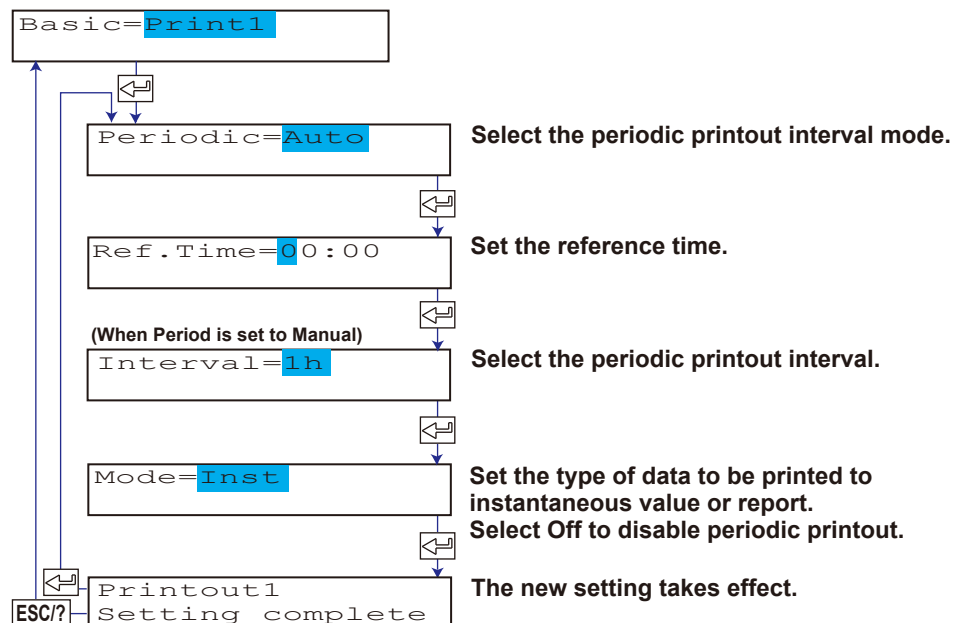

Applying the Changes and Returning to Operation Mode

Press the **▽△** key or **SHIFT + ▽△** key to select **End** and then press the **↵** key. Press the **▽△** key to select **Store** and then press the **↵** key. The changes are applied, and the screen returns to Operation mode. If you select **Abort** and press the **↵** key, the changes are discarded, and the screen returns to Operation mode. Press the **ESC** key to return to the **Basic=** screen.

Types of Report Data to Be Printed

Changing the Settings

1. Hold down the **MENU** key for 3 seconds to enter Setting mode.
2. Hold down the **▽△** and **◀▶** keys simultaneously for 3 seconds to enter Basic Setting mode.
3. Press the **▽△** key or **SHIFT + ▽△** key to select **Print2** and then press the **↵** key.
4. Set each item and press the **↵** key.
Use the **▽△** key or **SHIFT + ▽△** key to select values.
For the procedure on how to enter values or characters, see section 4.2.
If you press the **ESC** key in the middle of the operation, the settings entered up to then are cancelled, and the display returns to a higher level menu.
5. When the **Setting complete** screen appears, do either of the following:
Press the **↵** key to set other channels.
If you are done, press the **ESC** key.

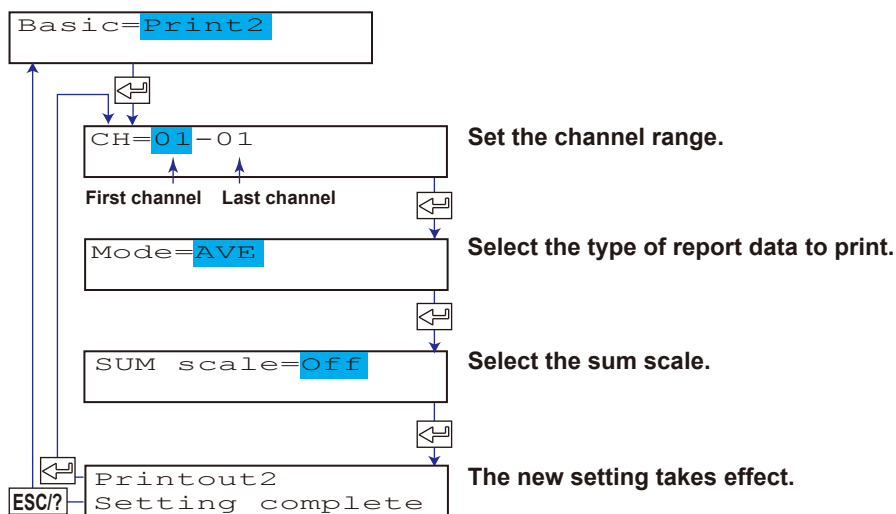

Applying the Changes and Returning to Operation Mode

Press the **▽△** key or **SHIFT + ▽△** key to select **End** and then press the **↵** key. Press the **▽△** key to select **Store** and then press the **↵** key. The changes are applied, and the screen returns to Operation mode. If you select **Abort** and press the **↵** key, the changes are discarded, and the screen returns to Operation mode. Press the **ESC** key to return to the **Basic=** screen.

Explanation

Periodic Printout Interval and Type of Data to Be Printed

Periodic

Select the periodic printout interval mode.

Auto: Automatically sets the printout interval in sync with the chart speed.

Manual: Set the printout interval manually.

Ref. Time

Sets the reference time for determining the times for executing the periodic printout.

The reference time is set in the range of 00 to 23 in 1 hour steps. Minutes cannot be specified.

Interval

Select the interval from 10, 12, 15, 20, 30 minutes, 1, 2, 3, 4, 6, 8, 12, and 24 hours.

However, printout might not take place at the specified interval depending on the chart speed and items printed (for details, see appendix 2).

Mode

Sets the type of measured values to be printed.

Inst: Prints the measured value or computed value (/M1 option) at that point.

Report: Prints the report over the interval. If Report is selected, set the types of report data to be printed as described in "Types of Report Data to Be Printed" below (computation channels are set in section 9.15).

Off: Disables periodic printout.

Types of Report Data to Be Printed

Mode

Sets the type of report data to be printed.

AVE: Prints the average value over the interval.

MIX: Prints the minimum, maximum, and average values over the interval.

SUM: Prints the sum value over the interval. If SUM is selected, set the sum scale.

MIN: Prints the minimum value over the interval.

MAX: Prints the maximum value over the interval.

INST: Prints the instantaneous value.

SUM scale

Set this item only when SUM is selected.

SUM sums the data every computation interval. For flow values that have units /s, /min, or /h, a simple summation results in the actual value not matching the computed result, because the scan interval and the unit of the input values are different. In such cases, set the sum scale to match the unit of the input value. In effect, the sum value with the same unit as that of the input value is calculated.

For example, if the scan interval is 1 s, and the input value is 100 m³/min, a simple summation would add 100 every 1 s resulting in 6000 after one minute. However, if the sum scale is set to /min, then 1 s/60 s is multiplied every scan interval before the value is added giving a result with an m³/min unit.

Off: Simply sums the measured values.

/s: Sums by converting the measured values to a value over 1 second.

/min: Sums by converting the measured values to a value over 1 minute.

/h: Sums by converting the measured values to a value over 1 hour.

/day: Sums by converting the measured values to a value over 1 day.

7.9 Setting the Bar Graph Display Mode

This section explains the details of setting the bar graph display mode. Basic Setting mode cannot be entered when recording is in progress or when computation is in progress on models with the computation function (/M1 option).

Procedure

Changing the Settings

1. Hold down the **MENU** key for 3 seconds to enter Setting mode.
2. Hold down the **▽△** and **<▷** keys simultaneously for 3 seconds to enter Basic Setting mode.
3. Press the **▽△** key or **SHIFT + ▽△** key to select **Bar graph** and then press the **<⇐** key.
4. Set each item and press the **<⇐** key.
Use the **▽△** key or **SHIFT + ▽△** key to select values.
For the procedure on how to enter values or characters, see section 4.2.
If you press the **ESC** key in the middle of the operation, the settings entered up to then are cancelled, and the display returns to a higher level menu.
5. When the **Setting complete** screen appears, do either of the following:
Press the **<⇐** key to set other channels.
If you are done, press the **ESC** key.

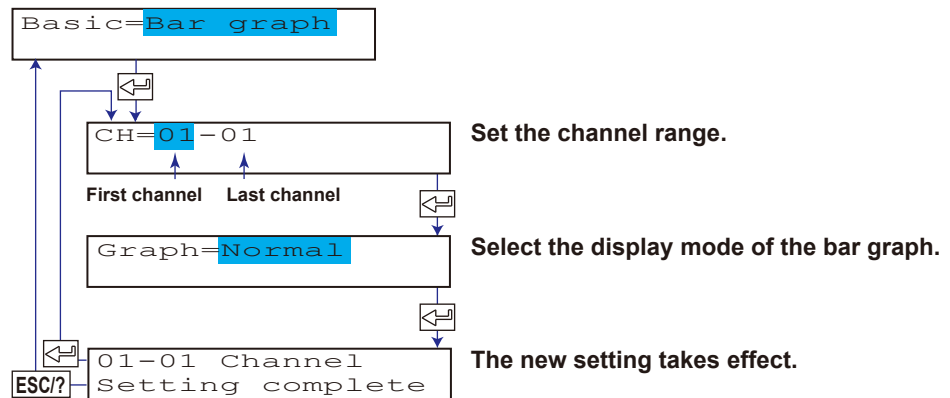

Applying the Changes and Returning to Operation Mode

Press the **▽△** key or **SHIFT + ▽△** key to select **End** and then press the **<⇐** key. Press the **▽△** key to select **Store** and then press the **<⇐** key. The changes are applied, and the screen returns to Operation mode. If you select **Abort** and press the **<⇐** key, the changes are discarded, and the screen returns to Operation mode. Press the **ESC** key to return to the **Basic=** screen.

Explanation

Graph

- Normal: Sets the base point of the bar graph to the left or right of the recording span whichever is smaller in value.
- Center: Sets the base point of the bar graph to the 50% position of the recording span.

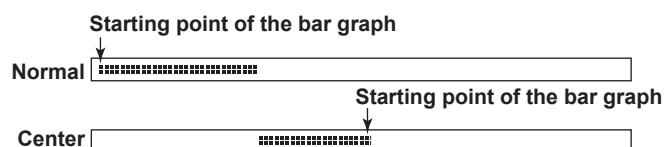

7.10 Setting the Key Lock Function

This section explains the details of setting the keys that can be locked and the password for releasing the key lock.

Basic Setting mode cannot be entered when recording is in progress or when computation is in progress on models with the computation function (/M1 option).

Procedure

Changing the Settings

1. Hold down the **MENU** key for 3 seconds to enter Setting mode.
2. Hold down the **▽△** and **◀▶** keys simultaneously for 3 seconds to enter Basic Setting mode.
3. Press the **▽△** key or **SHIFT + ▽△** key to select **Keylock** and then press the **↵** key.
4. Set each item and press the **↵** key.
Use the **▽△** key or **SHIFT + ▽△** key to select values.
For the procedure on how to enter values or characters, see section 4.2.
If you press the **ESC** key in the middle of the operation, the settings entered up to then are cancelled, and the display returns to a higher level menu.
5. When the **Setting complete** screen appears, do either of the following:
To correct the setting, press the **↵** key.
If you are done, press the **ESC** key.

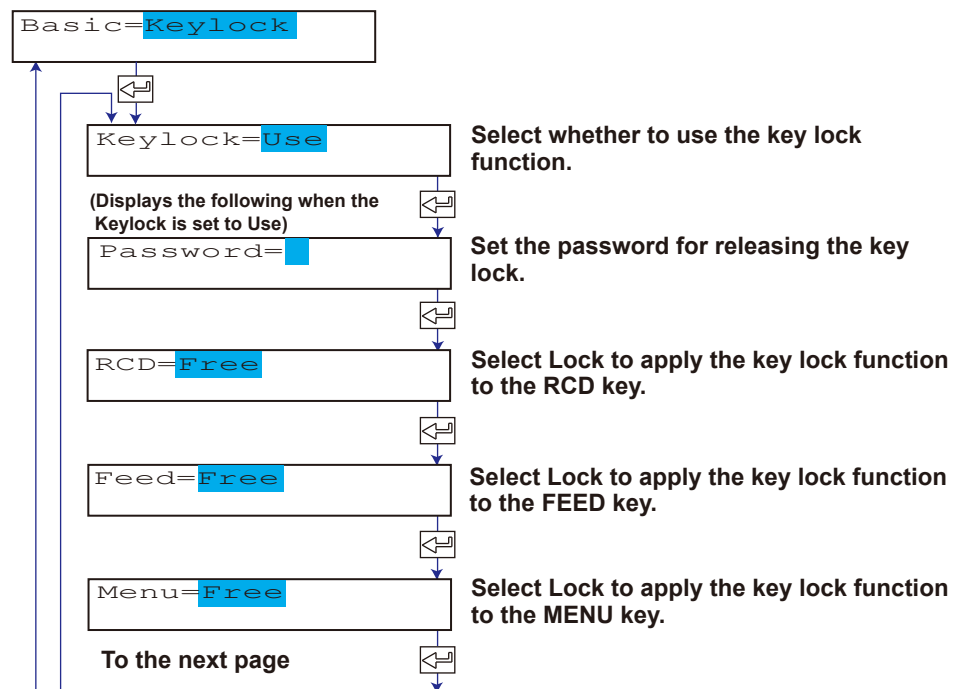

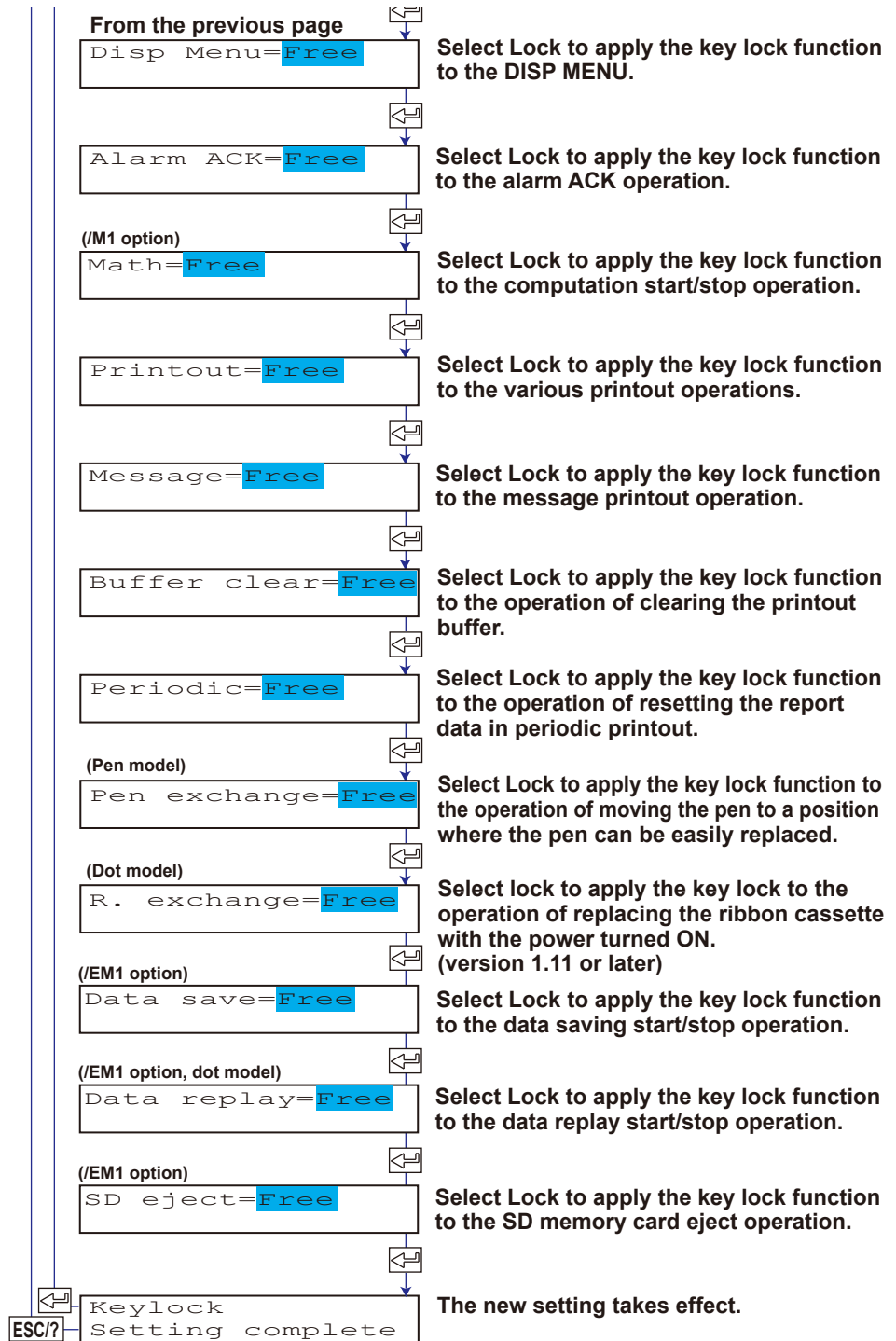

Applying the Changes and Returning to Operation Mode

Press the $\nabla\Delta$ key or **SHIFT** + $\nabla\Delta$ key to select **End** and then press the \leftarrow key. Press the $\nabla\Delta$ key to select **Store** and then press the \leftarrow key. The changes are applied, and the screen returns to Operation mode. If you select **Abort** and press the \leftarrow key, the changes are discarded, and the screen returns to Operation mode. Press the **ESC** key to return to the **Basic=** screen.

Explanation

Keylock

Sets whether to use or not use the key lock function.















If Not is selected, the setup ends here.

Password

Sets the password for releasing the key lock. Set the password using numbers and spaces within 4 digits.

Operation of Keys to Be Key-Locked

Sets the operation of the keys to be key-locked. Select Lock or Free for each key operation.

RCD:	 key
Feed:	 key
Menu:	 key
Disp Menu:	 key
Alarm ACK:	Alarm ACK operation under the  key
Math:	Computation start/stop/reset operation under the  key (/M1 option)
Print out:	Printout start/stop/reset operation under the  key
Message:	Message printout operation under the  key
Buffer clear:	Clear operation of the printout buffer memory under the  key
Periodic:	Clear operation of the report data of periodic printout under the  key
Pen exchange:	Operation of moving the pen to an easily accessible position of replacement under the  key (pen model)
R. exchange:	Operation carried out when replacing the ribbon cassette with the power turned ON under the  key (dot model)
Data save:	Start/stop operation for saving data to the SD memory card under the  key (/EM1 option)
Data replay:	Start/stop operation for replaying data from the SD memory card under the  key (/EM1 option, dot model)
SD eject:	Operation for ejecting the SD memory card under the  key (/EM1 option)

<Related Topics> Activating/Releasing the key lock: Section 3.13

7.11 Enabling the Moving Average Function (Dot Model)

This section explains the details of enabling/disabling the moving average function on the dot model.

Basic Setting mode cannot be entered when recording is in progress or when computation is in progress on models with the computation function (/M1 option).

Procedure

Changing the Settings

1. Hold down the **MENU** key for 3 seconds to enter Setting mode.
2. Hold down the **▽△** and **◀▶** keys simultaneously for 3 seconds to enter Basic Setting mode.
3. Press the **▽△** key or **SHIFT + ▽△** key to select **Moving_AVE** and then press the **↵** key.
4. Set each item and press the **↵** key.
Use the **▽△** key or **SHIFT + ▽△** key to select values.
For the procedure on how to enter values or characters, see section 4.2.
If you press the **ESC** key in the middle of the operation, the settings entered up to then are cancelled, and the display returns to a higher level menu.
5. When the **Setting complete** screen appears, do either of the following:
To correct the setting, press the **↵** key.
If you are done, press the **ESC** key.

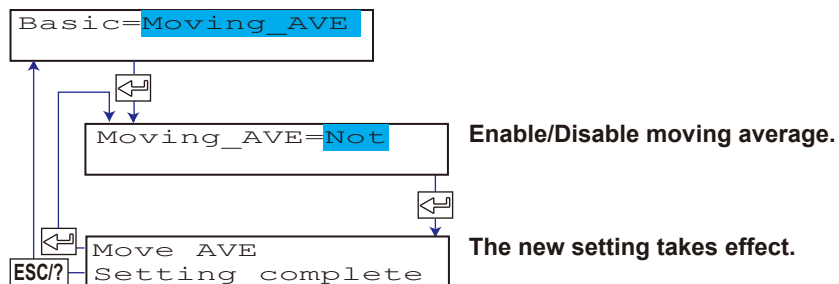

Applying the Changes and Returning to Operation Mode

Press the **▽△** key or **SHIFT + ▽△** key to select **End** and then press the **↵** key. Press the **▽△** key to select **Store** and then press the **↵** key. The changes are applied, and the screen returns to Operation mode. If you select **Abort** and press the **↵** key, the changes are discarded, and the screen returns to Operation mode. Press the **ESC** key to return to the **Basic=** screen.

Explanation

Moving_AVE

Use: Enables the setting of the number of samples of the moving average in Setting mode.

Not: The Moving_AVE item does not appear in Setting mode.

<Related Topics> Setting the moving average function: Section 6.3

7.12 Enabling the Filter Function (Pen Model)

This section explains details of enabling/disabling the input filter function on the pen model.

Basic Setting mode cannot be entered when recording is in progress or when computation is in progress on models with the computation function (/M1 option).

Procedure

Changing the Settings

1. Hold down the **MENU** key for 3 seconds to enter Setting mode.
2. Hold down the **▽△** and **◀▶** keys simultaneously for 3 seconds to enter Basic Setting mode.
3. Press the **▽△** key or **SHIFT + ▽△** key to select **Filter** and then press the **↵** key.
4. Set each item and press the **↵** key.
Use the **▽△** key or **SHIFT + ▽△** key to select values.
For the procedure on how to enter values or characters, see section 4.2.
If you press the **ESC** key in the middle of the operation, the settings entered up to then are cancelled, and the display returns to a higher level menu.
5. When the **Setting complete** screen appears, do either of the following:
To correct the setting, press the **↵** key.
If you are done, press the **ESC** key.

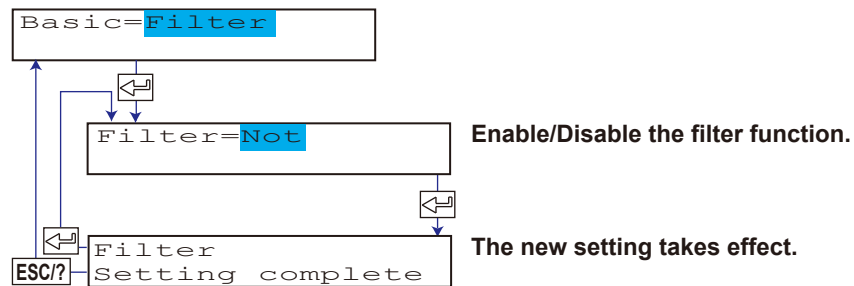

Applying the Changes and Returning to Operation Mode

Press the **▽△** key or **SHIFT + ▽△** key to select **End** and then press the **↵** key. Press the **▽△** key to select **Store** and then press the **↵** key. The changes are applied, and the screen returns to Operation mode. If you select **Abort** and press the **↵** key, the changes are discarded, and the screen returns to Operation mode. Press the **ESC** key to return to the **Basic=** screen.

Explanation

Filter

Use: Enables the setting of the filter time constant in Setting mode.

Not: The Filter item does not appear in Setting mode.

<Related Topics> Setting the filter: Section 6.2

7.13 Enabling the Partial Expanded Recording Function

This section explains the details of enabling/disabling the partial expanded recording function.

Basic Setting mode cannot be entered when recording is in progress or when computation is in progress on models with the computation function (/M1 option).

Procedure

Changing the Settings

1. Hold down the **MENU** key for 3 seconds to enter Setting mode.
2. Hold down the **▽△** and **◀▶** keys simultaneously for 3 seconds to enter Basic Setting mode.
3. Press the **▽△** key or **SHIFT + ▽△** key to select **Partial** and then press the **↵** key.
4. Set each item and press the **↵** key.
Use the **▽△** key or **SHIFT + ▽△** key to select values.
For the procedure on how to enter values or characters, see section 4.2.
If you press the **ESC** key in the middle of the operation, the settings entered up to then are cancelled, and the display returns to a higher level menu.
5. When the **Setting complete** screen appears, do either of the following:
To correct the setting, press the **↵** key.
If you are done, press the **ESC** key.

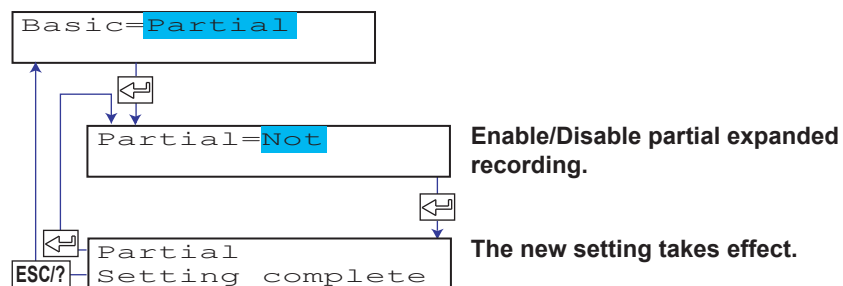

Applying the Changes and Returning to Operation Mode

Press the **▽△** key or **SHIFT + ▽△** key to select **End** and then press the **↵** key. Press the **▽△** key to select **Store** and then press the **↵** key. The changes are applied, and the screen returns to Operation mode. If you select **Abort** and press the **↵** key, the changes are discarded, and the screen returns to Operation mode. Press the **ESC** key to return to the **Basic=** screen.

Explanation

Partial

Use: Enables the setting of the boundary position and boundary value of the partial expanded recording function in Setting mode.

Not: The Partial item does not appear in Setting mode.

<Related Topics> Setting the partial expanded recording function: Section 6.5

7.14 Changing the Display/Printout Language

This section explains the details of changing the display/printout language. Basic Setting mode cannot be entered when recording is in progress or when computation is in progress on models with the computation function (/M1 option).

Procedure

Changing the Settings

1. Hold down the **MENU** key for 3 seconds to enter Setting mode.
2. Hold down the **▽△** and **◀▶** keys simultaneously for 3 seconds to enter Basic Setting mode.
3. Press the **▽△** key or **SHIFT + ▽△** key to select **Language** and then press the **↵** key.
4. Set each item and press the **↵** key.
Use the **▽△** key or **SHIFT + ▽△** key to select values.
For the procedure on how to enter values or characters, see section 4.2.
If you press the **ESC** key in the middle of the operation, the settings entered up to then are cancelled, and the display returns to a higher level menu.
5. When the **Setting complete** screen appears, do either of the following:
To correct the setting, press the **↵** key.
If you are done, press the **ESC** key.

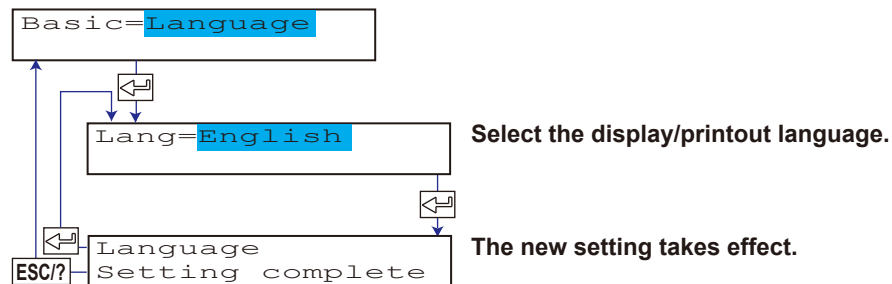

Applying the Changes and Returning to Operation Mode

Press the **▽△** key or **SHIFT + ▽△** key to select **End** and then press the **↵** key. Press the **▽△** key to select **Store** and then press the **↵** key. The changes are applied, and the screen returns to Operation mode. If you select **Abort** and press the **↵** key, the changes are discarded, and the screen returns to Operation mode. Press the **ESC** key to return to the **Basic=** screen.

Explanation

Lang (Language)

English (E): Uses the English alphabet, numbers, and symbols for display and printout.
German (G)*: Uses the German alphabet, numbers, and symbols for display and printout.
French (F)*: Uses the French alphabet, numbers, and symbols for display and printout.
Japanese (J): Uses the English alphabet, katakana, numbers, and symbols for display and printout.

*: German and French are supported on version 1.21 or later. The setup items of the customized menu and header printout (/BT1 option) are displayed in English.

7.15 Enabling the Bias, Low-Cut, Alarm Delay, Calibration Correction (/CC1 Option) Functions

This section explains the details of enabling/disabling the bias, low-cut, alarm delay, and calibration correction (/CC1 option) functions.

Basic Setting mode cannot be entered when recording is in progress or when computation is in progress on models with the computation function (/M1 option).

Procedure

Changing the Settings

1. Hold down the **MENU** key for 3 seconds to enter Setting mode.
2. Hold down the **▽△** and **◀▶** keys simultaneously for 3 seconds to enter Basic Setting mode.
3. Press the **▽△** key or **SHIFT + ▽△** key to select **Personalize** and then press the **↵** key.
4. Press the **↵** key with **Add function** shown on the screen.
5. Set each item and press the **↵** key.
Use the **▽△** key or **SHIFT + ▽△** key to select values.
For the procedure on how to enter values or characters, see section 4.2.
If you press the **ESC** key in the middle of the operation, the settings entered up to then are cancelled, and the display returns to a higher level menu.
6. When the **Setting complete** screen appears, do either of the following:
To correct the setting, press the **↵** key.
If you are done, press the **ESC** key.

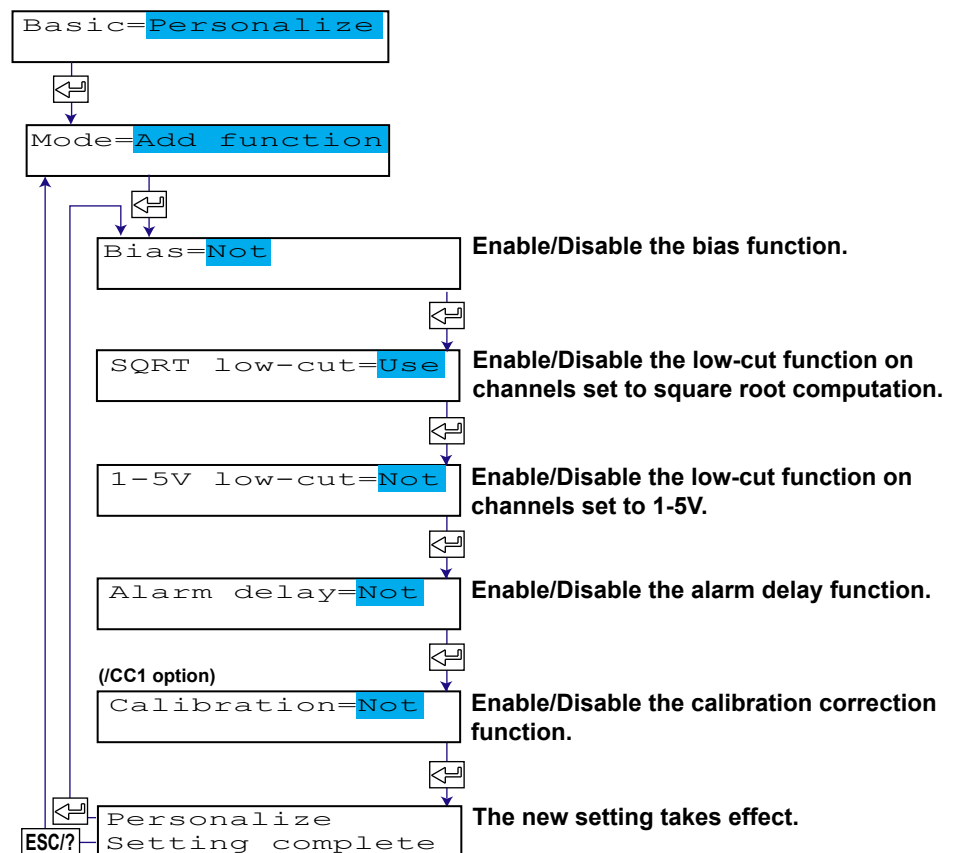

Applying the Changes and Returning to Operation Mode

Press the $\nabla\Delta$ key or **SHIFT** + $\nabla\Delta$ key to select **End** and then press the \leftarrow key. Press the $\nabla\Delta$ key to select **Store** and then press the \leftarrow key. The changes are applied, and the screen returns to Operation mode. If you select **Abort** and press the \leftarrow key, the changes are discarded, and the screen returns to Operation mode. Press the **ESC** key to return to the **Basic=** screen.

Explanation

Bias

Enables/Disables the bias function.

Use: Enables the setting of the bias value in Setting mode.

Not: The Bias item does not appear in Setting mode.

SQRT low-cut

Enables/Disables the square root low-cut function.

Use: Enables the setting of the low-cut function when a channel is set to square root computation in Setting mode.

Not: The SQRT low-cut item does not appear in Setting mode.

1-5V low-cut

Enables/Disables the 1-5V low-cut function.

Use: Enables the setting of the low-cut function when a channel is set to 1-5V in Setting mode.

Not: The 1-5V low-cut item does not appear in Setting mode.

Alarm delay

Enables/Disables the alarm delay function.

Use: Enables the setting of delay high limit alarm or delay low limit alarm for the alarm type.

Not: The delay high limit alarm and delay low limit alarm items do not appear as possible selections for the alarm type.

Calibration correction

Enables/Disables the calibration correction function.

Use: Enables the setting of the correction mode and the number of calibration points in Basic Setting mode and the setting of the correction points and correction values in Setting mode.

Not: The calibration item does not appear in Basic Setting or Setting mode.

Note

The bias and calibration correction functions (/CC1 option) cannot be enabled simultaneously.

<Related Topics> Setting the bias value: Section 6.12
Setting the low-cut value to the measured value: Section 5.1
Setting the delay high/low limit alarm: Section 5.2
Setting the correction mode and the number of calibration points for calibration correction: Section 7.23
Performing calibration correction: section 6.13

7.16 Changing the Time Printout Format

This section explains the details of changing the time printout format of alarm printout, message printout, recording start printout, and new chart speed printout. Basic Setting mode cannot be entered when recording is in progress or when computation is in progress on models with the computation function (/M1 option).

Procedure

Changing the Settings

1. Hold down the **MENU** key for 3 seconds to enter Setting mode.
2. Hold down the **▽△** and **◀▶** keys simultaneously for 3 seconds to enter Basic Setting mode.
3. Press the **▽△** key or **SHIFT + ▽△** key to select **Personalize** and then press the **↵** key.
4. Press the **▽△** key or **SHIFT + ▽△** key to select **Time print** and then press the **↵** key.
5. Set each item and press the **↵** key.
Use the **▽△** key or **SHIFT + ▽△** key to select values.
For the procedure on how to enter values or characters, see section 4.2.
If you press the **ESC** key in the middle of the operation, the settings entered up to then are cancelled, and the display returns to a higher level menu.
6. When the **Setting complete** screen appears, do either of the following:
To correct the setting, press the **↵** key.
If you are done, press the **ESC** key.

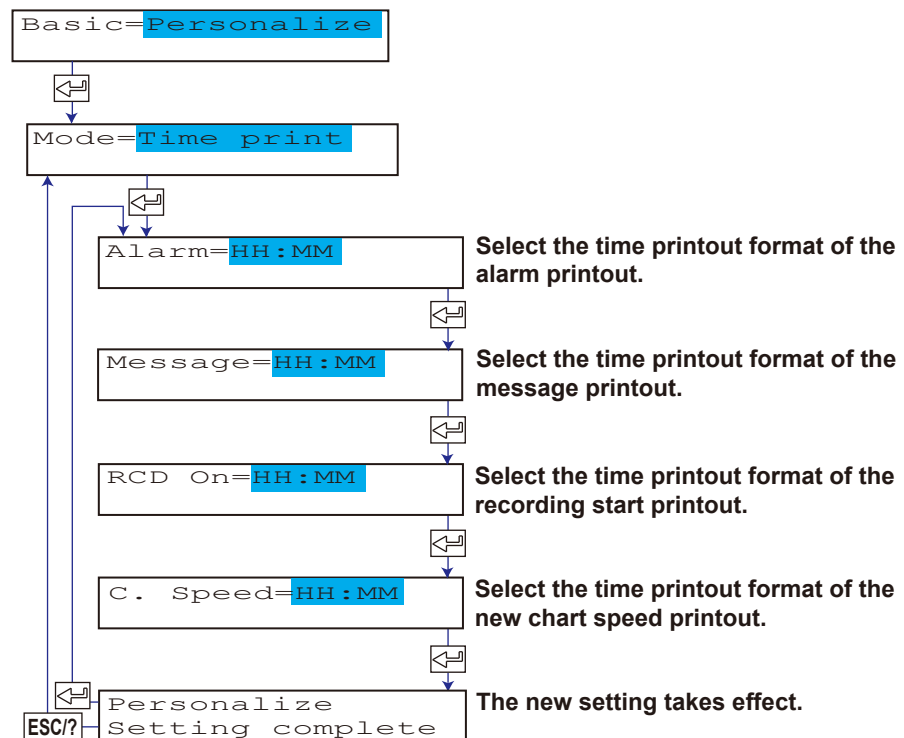

Applying the Changes and Returning to Operation Mode

Press the **▽△** key or **SHIFT + ▽△** key to select **End** and then press the **↵** key. Press the **▽△** key to select **Store** and then press the **↵** key. The changes are applied, and the screen returns to Operation mode. If you select **Abort** and press the **↵** key, the changes are discarded, and the screen returns to Operation mode. Press the **ESC** key to return to the **Basic=** screen.

Explanation

Alarms

Sets the time printout format of the alarm printout.

HH:MM: Hour:Minute

HH:MM:SS: Hour:Minute:Second

M/D H:M: Month Day Hour:Minute

M/D H:M:S: Month Day Hour:Minute:Second

YMD H:M:S: Month Day Year Hour:Minute:Second

Message

Sets the time printout format of the message printout.

HH:MM: Hour:Minute

HH:MM:SS: Hour:Minute:Second

M/D H:M: Month Day Hour:Minute

M/D H:M:S: Month Day Hour:Minute:Second

YMD H:M:S: Month Day Year Hour:Minute:Second

None: Does not print the date/time.

RCD On

Sets the time printout format of the record start time printout

The format is the same as that of the alarm printout.

C. Speed

Selects the time printout format of the new chart speed printout.

The format is the same as that of the alarm printout.

Note

The printout format of the year, month, and day varies depending on the printout/display format of the date (see section 7.19).

7.17 Initializing the Settings

This section explains the details of initializing the recorder settings to their factory default. Be careful, because all settings except the date/time and the adjustment values of the pen/dot printing position will be initialized.

Basic Setting mode cannot be entered when recording is in progress or when computation is in progress on models with the computation function (/M1 option).

Procedure

1. Hold down the **MENU** key for 3 seconds to enter Setting mode.
2. Hold down the **▽△** and **◀▶** keys simultaneously for 3 seconds to enter Basic Setting mode.
3. Press the **▽△** key or **SHIFT + ▽△** key to select **Initialize** and then press the **↵** key.
4. Press the **▽△** key to select the settings to be initialized and then press the **↵** key.
5. To execute the initialization, press the **▽△** key to select **Yes** and then press the **↵** key.

Set: Initializes the settings in Setting mode.

Setup+Set: Initializes the settings in Basic Setting mode and Setting mode.

The settings are initialized, and the recorder returns to Operation mode.

To cancel the initialization, press the **ESC** key. The screen returns to the **Basic=Initialize** screen.

If you press the **▽△** key to select **No** and press then the **↵** key, nothing happens.

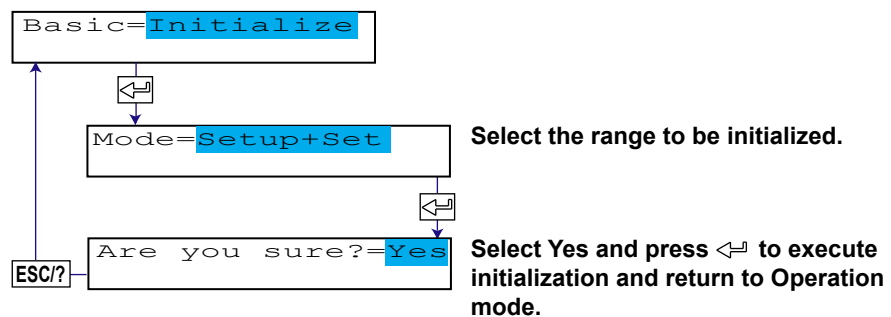

Explanation

Items That Are Not Initialized

The following items are not initialized.

- Adjustment value of the pen position and the adjustment value of the printer carriage position (Basic Setting mode)
- Date/Time (Setting mode)

7.18 Assigning Functions to the Remote Control Input Terminals (/R1 Option)

This section explains the details of assigning functions to the input terminals of the remote control function.

Basic Setting mode cannot be entered when recording is in progress or when computation is in progress on models with the computation function (/M1 option).

Procedure

Changing the Settings

1. Hold down the **MENU** key for 3 seconds to enter Setting mode.
2. Hold down the **▽△** and **◀▶** keys simultaneously for 3 seconds to enter Basic Setting mode.
3. Press the **▽△** key or **SHIFT + ▽△** key to select **Remote** and then press the **↵** key.
4. Set each item and press the **↵** key.
Use the **▽△** key or **SHIFT + ▽△** key to select values.
For the procedure on how to enter values or characters, see section 4.2.
If you press the **ESC** key in the middle of the operation, the settings entered up to then are cancelled, and the display returns to a higher level menu.
5. When the **Setting complete** screen appears, do either of the following:
To correct the setting, press the **↵** key.
If you are done, press the **ESC** key.

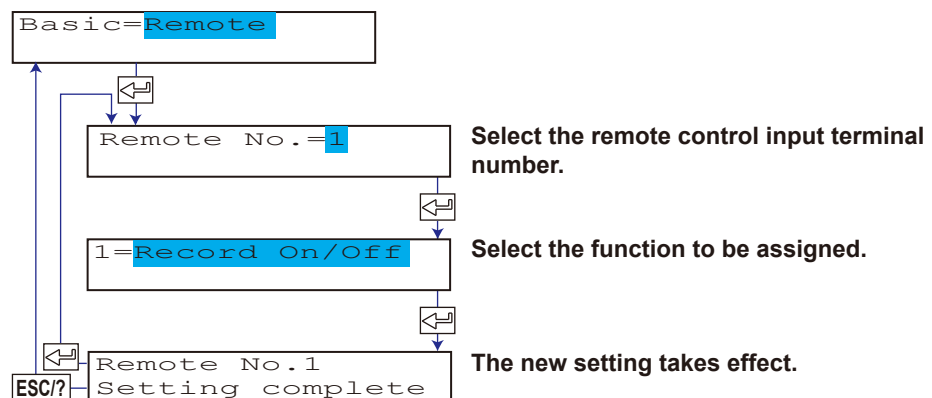

Applying the Changes and Returning to Operation Mode

Press the **▽△** key or **SHIFT + ▽△** key to select **End** and then press the **↵** key. Press the **▽△** key to select **Store** and then press the **↵** key. The changes are applied, and the screen returns to Operation mode. If you select **Abort** and press the **↵** key, the changes are discarded, and the screen returns to Operation mode. Press the **ESC** key to return to the **Basic=** screen.

Explanation**Remote No.**

The remote control terminal numbers are from 1 to 5.

Function to Be Assigned

Record On/Off:	Starts/stops recording.
Alarm ACK:	Executes alarm output release.
Time adjust:	Adjusts the internal clock to the nearest hour.
Manual print:	Executes manual printout.
Message #:	Prints message # (where # is a value between 1 and 5).
Chart speed:	Changes the chart speed.
Math start/stop:	Starts/stops the computation on the computation function (/M1 option).
Math reset:	Resets the computed result of the computation function (/M1 option).
Priority R_RCD:	Starts/stops recording (/BT1 option).
BatchCMT switch:	Start printout and Start printout 2, End printout and End printout 2 switches according to the status of the "BatchCMT switch" signal during the rising or falling of the "Record On/Off" or "Priority R_RCD" signal (/BT1 option).
Data save On/Off:	Starts/stops data saving to the SD memory card (/EM1 option).
None:	No function is assigned.

Note

When you select "Priority R_RCD" and start recording remotely, you cannot stop recording using key operation or communications.

<Related Topics> Setting the secondary chart speed: Section 6.9

7.19 Changing the Printout/Display Format of the Date

This section explains how to change the printout/display format of the year, month, and day. This function is available on version 1.11 or later.

Basic Setting mode cannot be entered when recording is in progress or when computation is in progress on models with the computation function (/M1 option).

Procedure

Changing the Settings

1. Hold down the **MENU** key for 3 seconds to enter Setting mode.
2. Hold down the **▽△** and **◀▶** keys simultaneously for 3 seconds to enter Basic Setting mode.
3. Press the **▽△** key or **SHIFT + ▽△** key to select **Date format** and then press the **↵** key.
4. Set each item and press the **↵** key.
Use the **▽△** key or **SHIFT + ▽△** key to select values.
For the procedure on how to enter values or characters, see section 4.2.
If you press the **ESC** key in the middle of the operation, the settings entered up to then are cancelled, and the display returns to a higher level menu.
5. When the **Setting complete** screen appears, do either of the following:
To correct the setting, press the **↵** key.
If you are done, press the **ESC** key.

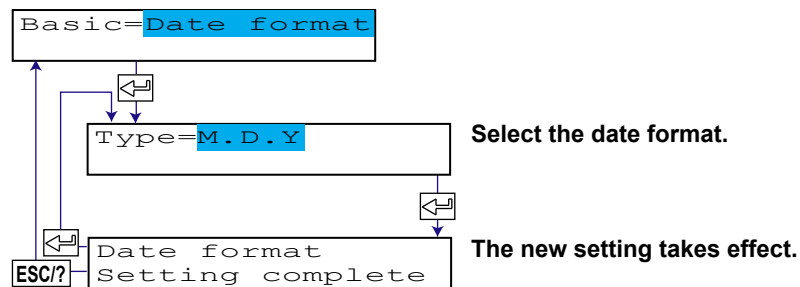

Applying the Changes and Returning to Operation Mode

Press the **▽△** key or **SHIFT + ▽△** key to select **End** and then press the **↵** key. Press the **▽△** key to select **Store** and then press the **↵** key. The changes are applied, and the screen returns to Operation mode. If you select **Abort** and press the **↵** key, the changes are discarded, and the screen returns to Operation mode. Press the **ESC** key to return to the **Basic=** screen.

Explanation

Date Format

Setting	Format Example	Note
Y/M/D	2005/8/31	
M/D/Y	8/31/2005	
D/M/Y	31/8/2005	
D.M.Y	31.8.2005	
M.D.Y	Aug.31.2005	Default value

7.20 Selecting to Show/Hide the FUNC Key Menus

Select the menu for showing/hiding the FUNC key menus. This function is available on version 1.31 or later.

Basic Setting mode cannot be entered when recording is in progress or when computation is in progress on models with the computation function (/M1 option).

Procedure

Changing the Settings

1. Hold down the **MENU** key for 3 seconds to enter Setting mode.
2. Hold down the **▽△** and **◀▶** keys simultaneously for 3 seconds to enter Basic Setting mode.
3. Press the **▽△** key or **SHIFT + ▽△** key to select **Select menu** and then press the **↵** key.
4. Press the **↵** key with **Function** shown on the screen.
5. Set each item and press the **↵** key.
Use the **▽△** key or **SHIFT + ▽△** key to select values.
For the procedure on how to enter values or characters, see section 4.2.
If you press the **ESC** key in the middle of the operation, the settings entered up to then are cancelled, and the display returns to a higher level menu.
6. When the **Setting complete** screen appears, do either of the following:
To correct the setting the **↵** key.
If you are done, press the **ESC** key.

7.20 Selecting to Show/Hide the FUNC Key Menus

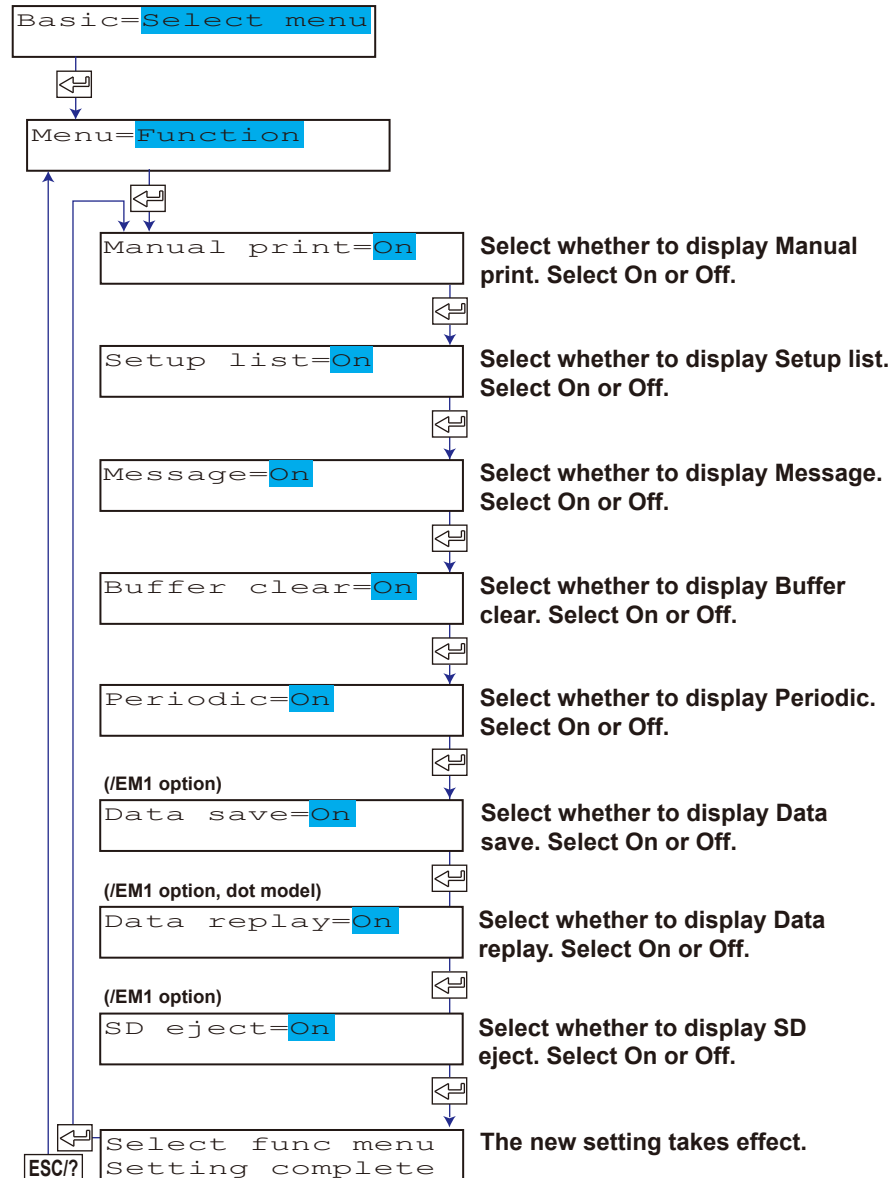

Applying the Changes and Returning to Operation Mode

Press the $\nabla\Delta$ key or **SHIFT** + $\nabla\Delta$ key to select **End** and then press the \leftarrow key. Press the $\nabla\Delta$ key to select **Store** and then press the \leftarrow key. The changes are applied, and the screen returns to Operation mode. If you select **Abort** and press the \leftarrow key, the changes are discarded, and the screen returns to Operation mode. Press the **ESC** key to return to the **Basic=** screen.

Explanation

On: Display operation menus using the FUNC key.

Off: Do not display the operation menu using FUNC keys when Customized Menu is enabled.

<Related Topics> Enabling the Customized Menu: Section 7.22

7.21 Selecting to Show/Hide Setting Mode Menus

Select the menu for showing/hiding the Setting mode menus. This function is available on version 1.31 or later.

Basic Setting mode cannot be entered when recording is in progress or when computation is in progress on models with the computation function (/M1 option).

Procedure

Changing the Settings

1. Hold down the **MENU** key for 3 seconds to enter Setting mode.
2. Hold down the **▽△** and **◀▶** keys simultaneously for 3 seconds to enter Basic Setting mode.
3. Press the **▽△** key or **SHIFT + ▽△** key to select **Select menu** and then press the **↵** key.
4. Press the **↵** key with **Set mode** shown on the screen.
5. Set each item and press the **↵** key.
Use the **▽△** key or **SHIFT + ▽△** key to select values.
For the procedure on how to enter values or characters, see section 4.2.
If you press the **ESC** key in the middle of the operation, the settings entered up to then are cancelled, and the display returns to a higher level menu.
6. When the **Setting complete** screen appears, do either of the following:
To correct the setting the **↵** key.
If you are done, press the **ESC** key.

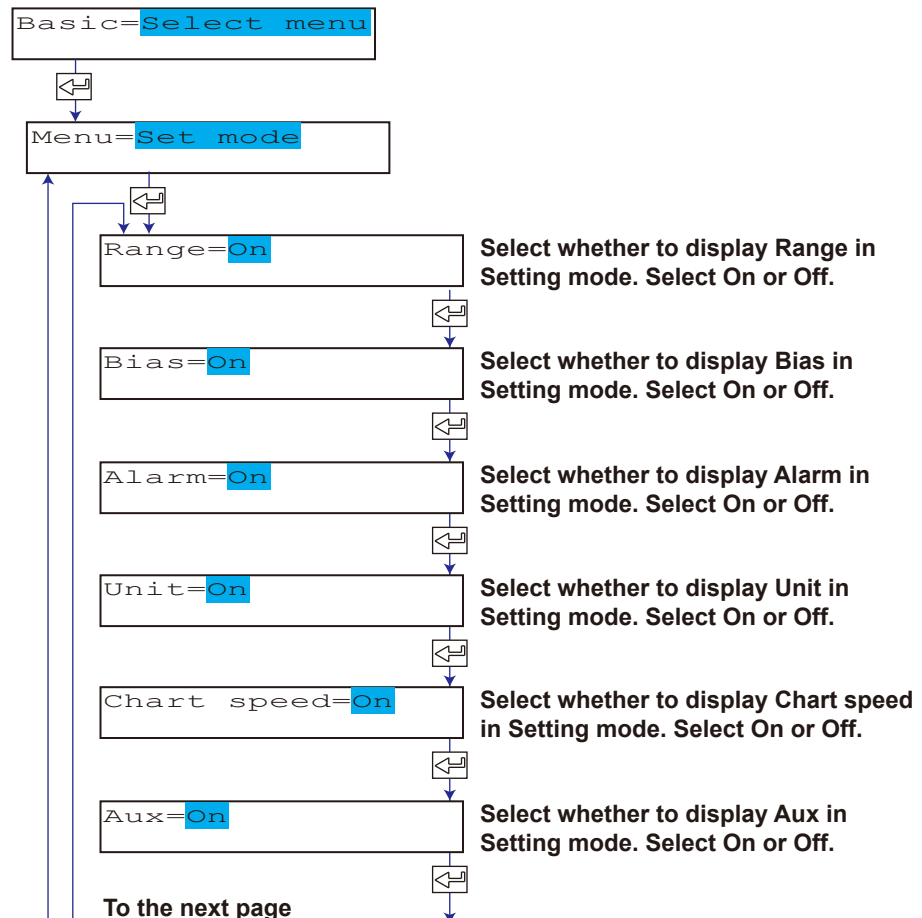

7.21 Selecting to Show/Hide Setting Mode Menus

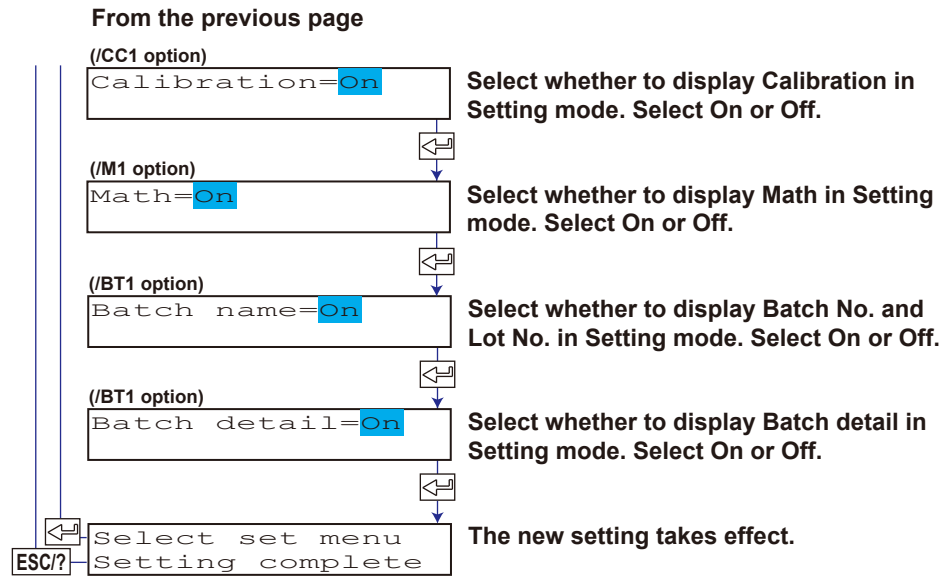

Applying the Changes and Returning to Operation Mode

Press the $\nabla\Delta$ key or **SHIFT** + $\nabla\Delta$ key to select **End** and then press the \leftarrow key. Press the $\nabla\Delta$ key to select **Store** and then press the \leftarrow key. The changes are applied, and the screen returns to Operation mode. If you select **Abort** and press the \leftarrow key, the changes are discarded, and the screen returns to Operation mode. Press the **ESC** key to return to the **Basic=** screen.

Explanation

On: Display the menu in Setting mode.

Off: Do not display the menu in Setting mode when Customized Menu is enabled.

<Related Topics> Enabling the Customized Menu: Section 7.22

7.22 Enabling/Disabling the Customized Menu

When the Customized Menu is enabled, the following changes can be made. This function is available on version 1.31 or later.

- Hide specified menu items from the FUNC key menu.
- Hide specified Setting mode menu items.
- Lock Basic Setting mode.

Basic Setting mode cannot be entered when recording is in progress or when computation is in progress on models with the computation function (/M1 option).

Procedure

Enabling the Customized Menu

Changing the Settings

1. Hold down the **MENU** key for 3 seconds to enter Setting mode.
2. Hold down the **▽△** and **◀▶** keys simultaneously for 3 seconds to enter Basic Setting mode.
3. Press the **▽△** key or **SHIFT + ▽△** key to select **Cust. menu** and then press the **↵** key.
4. Set each item and press the **↵** key.
Use the **▽△** key or **SHIFT + ▽△** key to select values.
For the procedure on how to enter values or characters, see section 4.2.
If you press the **ESC** key in the middle of the operation, the settings entered up to then are cancelled, and the display returns to a higher level menu.
5. When the **Setting complete** screen appears, do either of the following:
To correct the setting the **↵** key.
If you are done, press the **ESC** key.

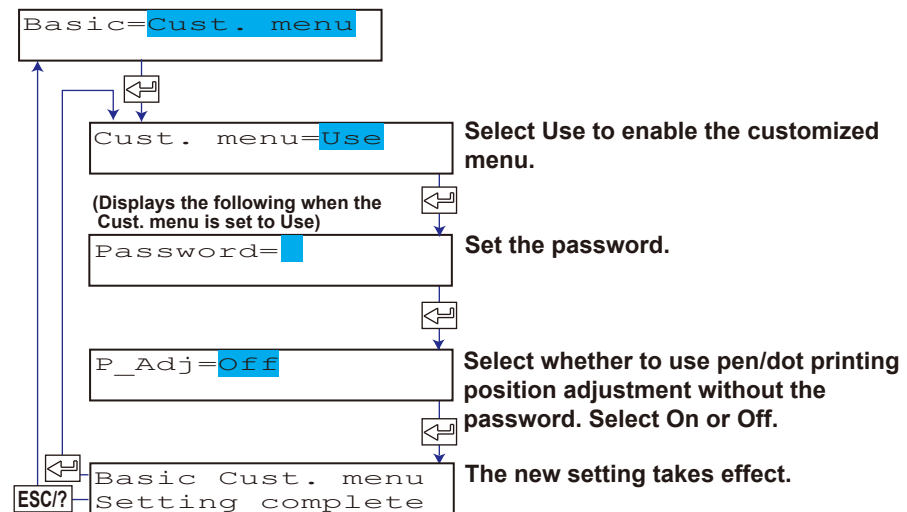

Applying the Changes and Returning to Operation Mode

Press the **▽△** key or **SHIFT + ▽△** key to select **End** and then press the **↵** key. Press the **▽△** key to select **Store** and then press the **↵** key. The changes are applied, and the screen returns to Operation mode. If you select **Abort** and press the **↵** key, the changes are discarded, and the screen returns to Operation mode. Press the **ESC** key to return to the **Basic=** screen.

Disabling the Customized Menu

Changing the Settings

1. Hold down the **MENU** key for 3 seconds to enter Setting mode.
2. Hold down the **▽△** and **◀▶** keys simultaneously for 3 seconds to enter Basic Setting mode.
3. Press the **▽△** key or **SHIFT + ▽△** key to select **Lock** and then press the **↵** key.
4. Set each item and press the **↵** key.
Use the **▽△** key or **SHIFT + ▽△** key to select values.
For the procedure on how to enter values or characters, see section 4.2.
If you press the **ESC** key in the middle of the operation, the settings entered up to then are cancelled, and the display returns to a higher level menu.
5. When the **Setting complete** screen appears, do either of the following:
To correct the setting the **↵** key.
If you are done, press the **ESC** key.

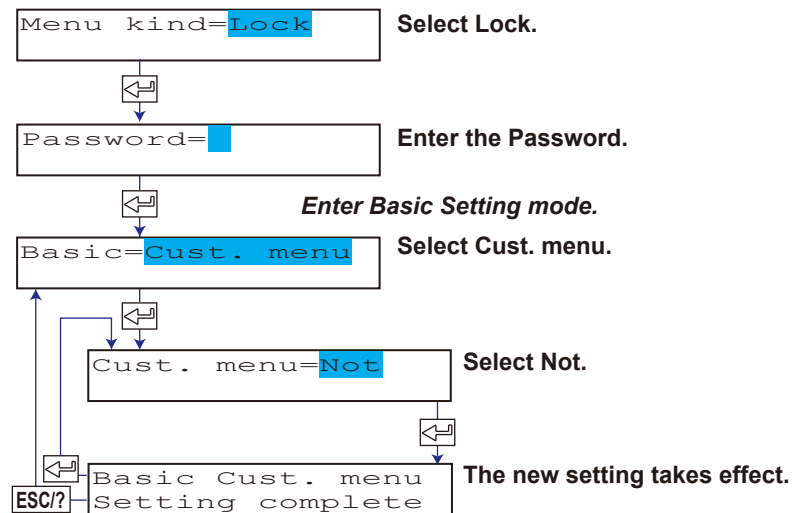

Applying the Changes and Returning to Operation Mode

Press the **▽△** key or **SHIFT + ▽△** key to select **End** and then press the **↵** key. Press the **▽△** key to select **Store** and then press the **↵** key. The changes are applied, and the screen returns to Operation mode. If you select **Abort** and press the **↵** key, the changes are discarded, and the screen returns to Operation mode. Press the **ESC** key to return to the **Basic=** screen.

Explanation

Cust. menu (Customized Menu)

Use: Displays only the desired Setting mode and FUNC key menus, and locks Basic Setting mode.

Not: Displays all Setting mode and FUNC key menus, and releases the Basic Setting mode lock.

Password

The password required to release the customized menu or to enter Basic Setting mode. Set a password of four digits or fewer, using numbers and spaces.

Note

Changing the Settings in Basic Setting Mode without Disabling the Basic Setting Mode Lock

The settings in Basic Setting mode can be changed without disabling the customized menu.

Procedure

1. Enter a password in the same manner as the procedure for “Disabling the Customized Menu,” press the \leftarrow key, and enter Basic Setting mode.
 2. Change settings in the usual manner.
 3. The instrument returns to Operation mode with Customized Menu still enabled.
-

<Related Topics> Selecting to show/hide the FUNC key menus: Section 7.20
Selecting to show/hide setting mode menus: Section 7.21
Adjusting the pen position/dot printing position: Sections 11.5 and 11.6

7.23 Setting the Calibration Correction Function (/CC1 Option)

This section explains the details of setting the correction mode and the number of calibration points.

Basic Setting mode cannot be entered when recording is in progress or when computation is in progress on models with the computation function (/M1 option).

Procedure

Changing the Settings

1. Hold down the **MENU** key for 3 seconds to enter Setting mode.
2. Hold down the **▽△** and **◀▶** keys simultaneously for 3 seconds to enter Basic Setting mode.
3. Press the **▽△** key or **SHIFT + ▽△** key to select **Calibration** and then press the **↵** key.
4. Set each item and press the **↵** key.
Use the **▽△** key or **SHIFT + ▽△** key to select values.
For the procedure on how to enter values or characters, see section 4.2.
If you press the **ESC** key in the middle of the operation, the settings entered up to then are cancelled, and the display returns to a higher level menu.
5. When the **Setting complete** screen appears, do either of the following:
To correct the setting, press the **↵** key.
If you are done, press the **ESC** key.

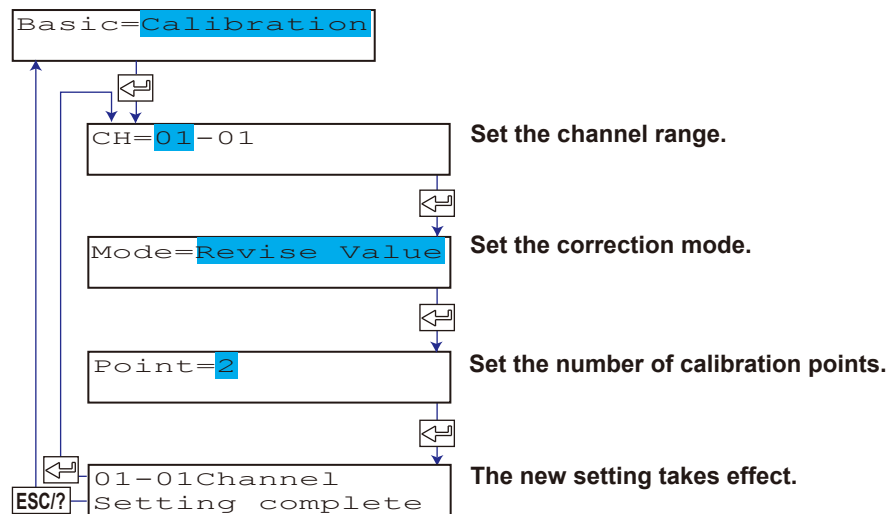

Applying the Changes and Returning to Operation Mode

Press the **▽△** key or **SHIFT + ▽△** key to select **End** and then press the **↵** key. Press the **▽△** key to select **Store** and then press the **↵** key. The changes are applied, and the screen returns to Operation mode. If you select **Abort** and press the **↵** key, the changes are discarded, and the screen returns to Operation mode. Press the **ESC** key to return to the **Basic=** screen.

Explanation

Mode

Revise Value: Sets the correction value using the revise value (corrected value – measured value).

Abs. Value: Sets the correction value using the corrected value.

Point

Selects the number of points that make up the segments (including the start and end points) in the range of 2 to 16.

<Related Topics> Enabling the calibration correction function: Section 7.15
Setting the correction values: Section 6.13

7.24 Enabling Start Printout, End printout, and Message Format (/BT1 Option)

This section explains the details of enabling/disabling the Start printout, End printout, and Message format.

Basic Setting mode cannot be entered when recording is in progress or when computation is in progress on models with the computation function (/M1 option).

Procedure

Changing the Settings

1. Hold down the **MENU** key for 3 seconds to enter Setting mode.
2. Hold down the **▽△** and **◀▶** keys simultaneously for 3 seconds to enter Basic Setting mode.
3. Press the **▽△** key or **SHIFT + ▽△** key to select **Batch** and then press the **↵** key.
4. Set each item and press the **↵** key.
Use the **▽△** key or **SHIFT + ▽△** key to select values.
For the procedure on how to enter values or characters, see section 4.2.
If you press the **ESC** key in the middle of the operation, the settings entered up to then are cancelled, and the display returns to a higher level menu.
5. When the **Setting complete** screen appears, do either of the following:
To correct the setting the **↵** key.
If you are done, press the **ESC** key.

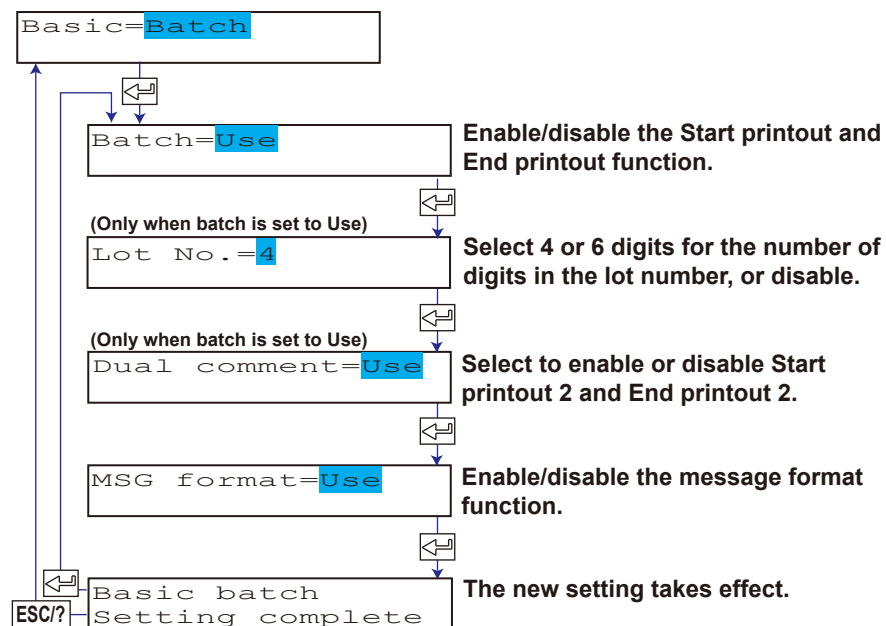

Applying the Changes and Returning to Operation Mode

Press the **▽△** key or **SHIFT + ▽△** key to select **End** and then press the **↵** key. Press the **▽△** key to select **Store** and then press the **↵** key. The changes are applied, and the screen returns to Operation mode. If you select **Abort** and press the **↵** key, the changes are discarded, and the screen returns to Operation mode. Press the **ESC** key to return to the **Basic=** screen.

Explanation

Batch

Use: When starting/stopping recording, performs Start printout and End printout. You can now set up "Lot No.," "Dual comment," and, in Setting mode, "Batch."

Not: Do not perform Start printout/End printout.

Lot No.

Batch name = Batch No. (character string) and Lot No. (number)

4: Prints out a 4-digit lot number. You can now set this under "Lot No." in Setting mode.

6: Prints out a 6-digit lot number. You can now set this under "Lot No." in Setting mode.

Not: Does not perform printout of the lot number.

Dual comment

Use: You can now select Start printout 2 and End printout 2 in Setting mode's Mode.

Not: There are no Start printout 2 and End printout 2 choices in Setting mode's Mode.

MSG Format

Use: You can now set the MSG format in Setting mode.

Not: The MSG format item is not displayed in Setting mode.

<Related Topics> Setting the start printout and end printout: Section 6.14
Setting the batch comment switch: Section 7.18
Setting the message format: section 6.15

Note

Enabling the header printout (/BT1 option) function performs the following operation.

- When the power supply stops and then resumes, recording remains stopped.

7.25 Changing the Temperature Unit

This section explains the details of changing the temperature unit on the temperature measurement channels.

Basic Setting mode cannot be entered when recording is in progress or when computation is in progress on models with the computation function (/M1 option).

Procedure

Changing the Settings

1. Hold down the **MENU** key for 3 seconds to enter Setting mode.
2. Hold down the **▽△** and **◀▶** keys simultaneously for 3 seconds to enter Basic Setting mode.
3. Press the **▽△** key or **SHIFT + ▽△** key to select **Temperature** and then press the **↵** key.
4. Set each item and press the **↵** key.
Use the **▽△** key or **SHIFT + ▽△** key to select values.
For the procedure on how to enter values or characters, see section 4.2.
If you press the **ESC** key in the middle of the operation, the settings entered up to then are cancelled, and the display returns to a higher level menu.
5. When the **Setting complete** screen appears, do either of the following:
To correct the setting, press the **↵** key.
If you are done, press the **ESC** key.

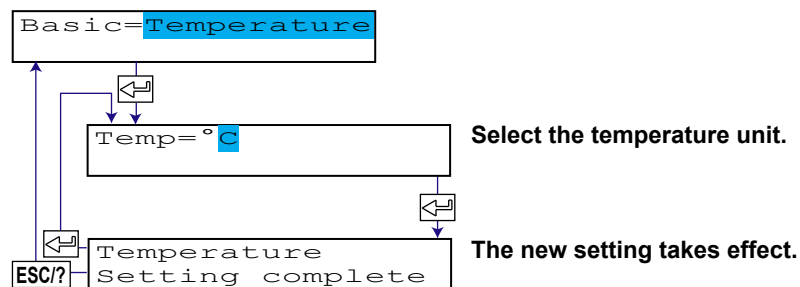

Applying the Changes and Returning to Operation Mode

Press the **▽△** key or **SHIFT + ▽△** key to select **End** and then press the **↵** key. Press the **▽△** key to select **Store** and then press the **↵** key. The changes are applied, and the screen returns to Operation mode. If you select **Abort** and press the **↵** key, the changes are discarded, and the screen returns to Operation mode. Press the **ESC** key to return to the **Basic=** screen.

Explanation

Temp (Temperature)

The setting is applied to all temperature measurement channels.

°C: Use Celsius.

°F: Use Fahrenheit.

8.1 Key Operations for Changing the Displayed Information

Displaying the Data Display Setup Screen

Hold the **[MENU]** key for 3 seconds to show the data display setup screen.



The panel keys are set to the functions marked above the keys as shown below.



Returning from the Data Display Setup Screen to Data Display Screen

Hold the **[MENU]** key for 3 seconds to return from the data display setup screen to data display screen.

Note

When the data display setup screen is shown, operations such as measurement, alarm, and recording continue.

Data Display Setup Menu

This menu is used to assign display types to screen 01 to 15. The indicates a display type. The items to set for each type are shown to the right of the display type.

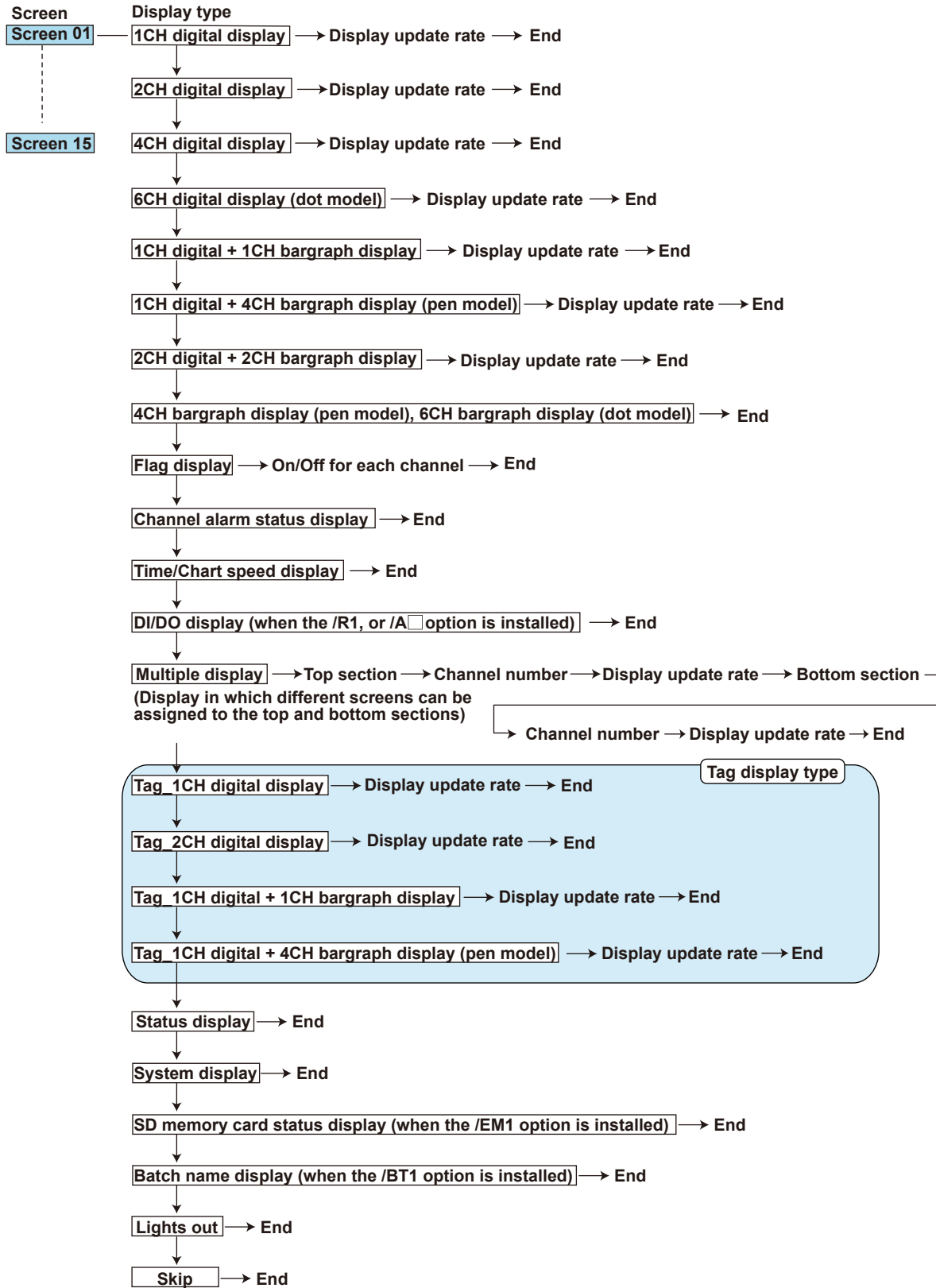

The display update rate corresponds to "Interval" in the setup menu. It is the time interval at which the displayed channel is switched.

Procedure

Display in Which Different Screens Can Be Assigned to the Top and Bottom Sections (Top: 2-Channel Digital Display, Bottom: Date/Time)

1. Hold the **MENU** key for 3 seconds to show the data display setup screen.
2. Press the **▽△** key or **SHIFT + ▽△** key to select the screen number and then press the **▽△** key.
A sample screen of the display type appears. A section of the display blinks to indicate that this is a data display setup screen.
3. Press the **▽△** or **SHIFT + ▽△** key to switch the display. Select the display in which different screens can be assigned to the top and bottom sections (display in which UP and DW are shown at the left edge) and press the **↵** key.
4. Set the display type for the top section.
Press the **▽△** key or **SHIFT + ▽△** key to select 2-channel digital display, and then press the **↵** key.
Set the channel switching interval and other settings.
5. Set the display type for the bottom section.
Press the **▽△** key or **SHIFT + ▽△** key to select date/time, and press the **↵** key.
6. When the **Setting complete** screen appears, press the **↵** key.
Hold the **MENU** key down for 3 seconds to exit from the data display setup screen.

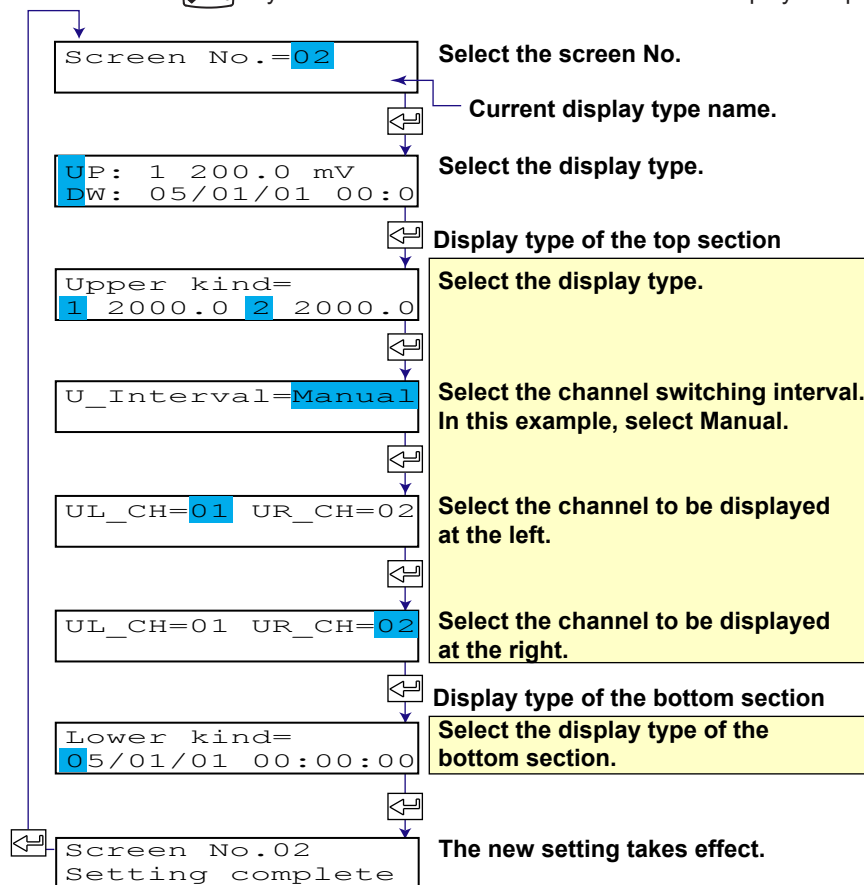

Explanation

Display in Which Different Screens Can Be Assigned to the Top and Bottom Sections

You can select the display type (see page 12-12) for the top and bottom sections.

Interval:

See “Interval” on the previous page.

9.1 Starting/Stopping/Resetting the Computation

This section explains the details of starting/stopping the computation and resetting the computed values of computation channels.

Procedure

Starting the Computation

1. Press the \rightarrow FUNC key.
2. Press the $\nabla\Delta$ key to show **Math** and then press the \leftarrow key.
3. Press the \leftarrow key with **Start** shown on the screen.
The computation starts, and the screen switches to the data display screen.
The word MATH in the status display comes on.

Math=Start

Stopping the Computation

1. Press the \rightarrow FUNC key.
2. Press the $\nabla\Delta$ key to show **Math** and then press the \leftarrow key.
3. Press the \leftarrow key with **Stop** shown on the screen.
The computation stops, and the screen switches to the data display screen.
The word MATH in the status display clears.

Math=Stop

Resetting the Computed Values of All Computation Channels to 0

This operation can be executed only when the computation is stopped.

1. Press the \rightarrow FUNC key.
2. Press the $\nabla\Delta$ key to show **Math** and then press the \leftarrow key.
3. Press the $\nabla\Delta$ key to show **Reset** and then press the \leftarrow key.
The computed values of all computation channels are reset, and the screen switches to the data display screen.

Math=Reset

* When the $\triangleleft\triangleright$ key or $\nabla\Delta$ key is pressed while holding down the **SHIFT** key, the operation is reversed as when the respective key is pressed by itself.

9.2 Setting the Computing Equation

The computing equation cannot be entered when the computation is in progress. If you change the computing equation or the recording span, set the alarm and the partial expanded recording again.

Procedure

1. Hold down the **MENU** key for 3 seconds to enter Setting mode.
2. Press the $\nabla\Delta$ key or **SHIFT + $\nabla\Delta$** key to select **Math** and then press the \leftarrow key.
3. Press the \leftarrow key with **Formula** shown on the screen.
4. Set each item and press the \leftarrow key.
Use the $\nabla\Delta$ key or **SHIFT + $\nabla\Delta$** key to select values.
For the procedure on how to enter values or characters, see section 4.2.
If you press the **ESC/?** key in the middle of the operation, the settings entered up to then are cancelled, and the display returns to a higher level menu.
5. When the **Setting complete** screen appears, do either of the following:
Press the \leftarrow key to set other channels.
If you are done, press the **ESC/?** key.
6. Hold down the **MENU** key for 3 seconds to return to Operation mode.

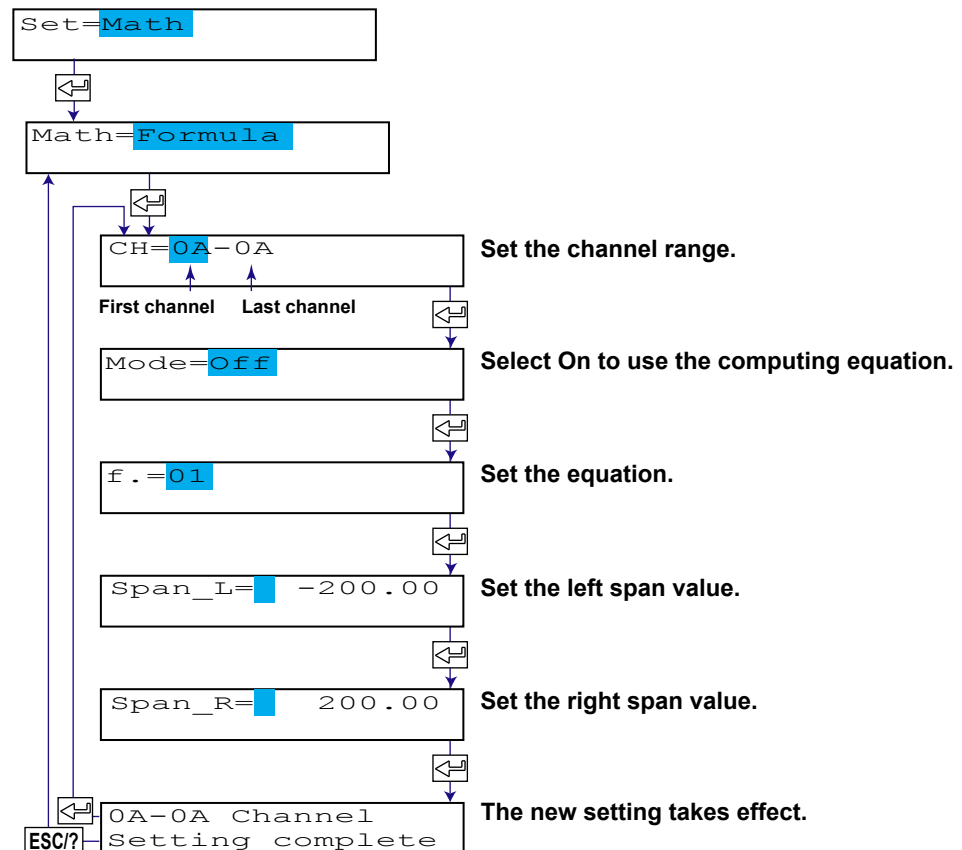

Setting the Computing Equation

The **CHARACTER**, $\nabla\Delta$, and $\leftarrow\triangleright$ keys are used to set the computing equation.

Use the $\leftarrow\triangleright$ key or **SHIFT + $\leftarrow\triangleright$** key to select the position for entering a character.

Use the **CHARACTER** key or **SHIFT + CHARACTER** key to select the character type.

Use the $\nabla\Delta$ key or **SHIFT + $\nabla\Delta$** key to select the character.

Each time you press the **CHARACTER** key the display changes as shown below. Pressing the $\nabla\Delta$ key or **SHIFT + $\nabla\Delta$** key switches the character within the selected character type and displays the character at the cursor position.

Display (CHARACTER key)	Description	Character ($\nabla\Delta$ key)
01...	Measurement channel number	Pen model: 01 to 04 Dot model: 01 to 06
0A...	Computation channel number	Pen model: 0A, 0B, 0C, 0D, 0E, 0F, 0G, 0J Dot model: 0A, 0B, 0C, 0D, 0E, 0F, 0G, 0J, 0K, 0M, 0N, 0P
+, -, *, /...	Symbol and space	+, -, *, /, (,), space
Function	Function	SQR(, ABS(, LOG(, EXP(, .EQ., .NE., .GT., .LT., .GE., .LE., AND, NOT, XOR, OR, TLOG.AVE(, TLOG.MAX(, TLOG.MIN(, TLOG.SUM(, TLOG.P-P(, space
K01-K30	Constant	K01 to K30
D01-D05	Status of the remote control terminals	D01 to D05
C01-C12	Communication input data	Pen model: C01 to C08 Dot model: C01 to C12
Ins DISP	Insert a character	
Del DISP	Delete a character	
Clear DISP	Delete the entire string	
Copy DISP	Store the entire string in the memory	
Past DISP	Paste the string in the memory	

Inserting a Character

Press the $\triangleleft\triangleright$ key or **SHIFT + $\triangleleft\triangleright$** key to move the cursor to the position where the character is to be inserted.

Press the **CHARACTER** key or **SHIFT + CHARACTER** key to show **Ins DISP** and then press the $\nabla\Delta$ key. A space for one character is inserted. Enter the character.

Deleting a Character

Use the $\triangleleft\triangleright$ key or **SHIFT + $\triangleleft\triangleright$** key to move the cursor to the character to be deleted.

Press the **CHARACTER** key or **SHIFT + CHARACTER** key to show **Del DISP** and then press the $\nabla\Delta$ key. The character is deleted.

Deleting an Entire Character String

Press the **CHARACTER** key or **SHIFT + CHARACTER** key to show **Clear DISP** and then press the $\nabla\Delta$ key. The entire character string is deleted.

Copying & Pasting a Character String

Show the copy source character string.

Press the **CHARACTER** key or **SHIFT + CHARACTER** key to show **Copy DISP** and then press the $\nabla\Delta$ key. The character string is saved to the memory.

Show the copy destination.

Press the **CHARACTER** key or **SHIFT + CHARACTER** key to show **Paste DISP** and then press the $\nabla\Delta$ key. The character string is pasted.

Explanation

Computing Equation

Follow the rules below when writing computing equations.

- Use up to 120 characters to write equations.
- The precedence of computing terms can be specified using parentheses.
- Specify the channels in the equation using 2-digit channel numbers.
Example: 01, 0A
- Specify the constants (K), communication input data (C), and remote control input terminal status (D) in the computing equation using 2-digit numbers.
Example: K01, C01, D01
- The data value for its own channel and channels that are greater in number than its own channel are substituted with the data from the previous scan.

Order of Precedence in Computations

The order of precedence of computation in equations is as follows:

Type	Operator
	(high order of precedence)
Function	ABS(), SQR(), LOG(), EXP(), TLOG.MAX(), TLOG.MIN(), TLOG.P-P(), TLOG.SUM(), TLOG.AVE()
Power	**
Logical negation	NOT
Multiplication and division	*, /
Addition and subtraction	+, -
Greater than and less than	.GT., .LT., GE., LE.
Equal and not equal	.EQ., .NE.
Logical product	AND
Logical sum and exclusive logical sum	OR, XOR
	(low order of precedence)

Data That Can Be Used in Equations

In TLOG computation, the measured values of measurement channels or computed values of computation channels can only be used. For all other computations, all of the data types below can be used.

- **Measured Values on Measurement Channels**
Specified by the channel number. For channels that have linear scaling enabled, the scaled values are used in the computation.
Pen model: 01 to 04, dot model: 01 to 06
- **Computed Values on Computation Channels**
Specified by the channel number.
Pen model: 0A, 0B, 0C, 0D, 0E, 0F, 0G, 0J
Dot model: 0A, 0B, 0C, 0D, 0E, 0F, 0G, 0J, 0K, 0M, 0N, 0P
- **Constants (K01 to K30)**
Enter the values as K01 to K30 in the equations.
Range of values (maximum significant digits is 5):
-9.9999E+29 to -1.0000E-30, 0, 1.0000E-30 to 9.9999E+29
- **Communication Input Data (Pen model: C01 to C08, dot model: C01 to C12)**
Enter the data as C01 to C12 in the equations.
Range of values (maximum significant digits is 5):
-9.9999E+29 to -1.0000E-30, 0, 1.0000E-30 to 9.9999E+29
For the procedure of setting the communication input data, see the *μR10000/μR20000 Communication Interface User's Manual (IM04P01B01-17E)*.

- **Status of the Remote Control Input Terminal (D01 to D05, /R1 option)**
The status of the remote control input signal (1 or 0) can be used in the computation. Use D01 to D05 (the number following the letter D is the remote control input terminal number) to specify the status in the equations.

Four Arithmetic Operation

The data that can be used in equations are measured values, computed values, constants, communication input data, and remote control input terminal status.

Equation Examples

- Addition 01+02
(Determines the sum of the measured values of channel 1 and channel 2.)
- Subtraction 01-02
(Determines the difference of the measured values of channel 1 and channel 2.)
- Multiplication 01*K03
(Multiplies constant K03 to the measured value of channel 1.)
- Division 01/K02
(Divides the measured value of channel 1 by constant K02.)

Note

By setting an equation similar to the one shown below, you can determine the accumulation of a specified channel (in this case channel 01) and make the result the computed value of computation channel 0A.

Computing equation of computation channel 0A: 0A+01

Power and Other Computations

The data that can be used in equations are measured values, computed values, constants, communication input data, and remote control input terminal status. You can nest a computing element inside the parentheses of another computing element.

Equation Examples

- Power 01**02
(Determines the measured value of channel 1 to the power of the measured value of channel 2.)
- Square root SQR(02)
(Determines the square root of the measured value of channel 2.)
- Absolute value ABS(02)
(Determines the absolute value of the measured value of channel 2.)
- Common logarithm LOG(01)
(Determines the common logarithm (\log_{10}) of the measured value of channel 1.)
- Exponent EXP(01)
(Determines e to the power of the measured value of channel 1.)

Note

You can determine the natural logarithm by setting an equation like the following.

From $\log_b X = \log_a X / \log_a b$, we obtain $\log_e X = \log_{10} X / \log_{10} e$

Hence, to determine the natural logarithm of channel 1, we set

Constant K01 = 0.43429($\log_{10} e$), and

Computing equation LOG(01)/K01.

Relational Computation

The data that can be used in equations are measured values, computed values, constants, communication input data, and remote control input terminal status. You can specify a computing equation that performs relational computation on a computing element. (Example: 01.LT.ABS(02))

Equation Examples

02.LT.03

If the measured value of channel 2 is less than the measured value of channel 3, the computed result is "1." Otherwise, the result is "0."

02.GT.03

If the measured value of channel 2 is greater than the measured value of channel 3, the computed result is "1." Otherwise, the result is "0."

02.EQ.03

If the measured value of channel 2 is equal to the measured value of channel 3, the computed result is "1." Otherwise, the result is "0."

02.NE.03

If the measured value of channel 2 is not equal to the measured value of channel 3, the computed result is "1." Otherwise, the result is "0."

02.GE.03

If the measured value of channel 2 is greater than or equal to the measured value of channel 3, the computed result is "1." Otherwise, the result is "0."

02.LE.03

If the measured value of channel 2 is less than or equal to the measured value of channel 3, the computed result is "1." Otherwise, the result is "0."

Logical Computation

Checks whether the two data values, e1 and e2 (e1 only for NOT), are zeroes or non-zeroes, and computes according to the conditions. The data that can be used in equations are measured values, computed values, constants, communication input data, and remote control input terminal status. You can specify a computing equation that performs logical computation on a computing element.

AND

Logical Product

(Syntax) e1ANDe2

(Condition) If the two data values e1 and e2 are both non-zeroes, the computed result is "1." Otherwise, it is "0."

(Explanation) e1 = 0 → e1ANDe2 = 0
e2 = 0

e1 ≠ 0 → e1ANDe2 = 0
e2 = 0

e1 = 0 → e1ANDe2 = 0
e2 ≠ 0

e1 ≠ 0 → e1ANDe2 = 1
e2 ≠ 0

OR

Logical sum

(Syntax) $e1ORe2$

(Condition) If the two data values e1 and e2 are both zeroes, the computed result is "0." Otherwise, it is "1."

(Explanation) $e1 = 0$
 $e2 = 0 \rightarrow e1ORe2 = 0$

$e1 \neq 0$
 $e2 = 0 \rightarrow e1ORe2 = 1$

$e1 = 0$
 $e2 \neq 0 \rightarrow e1ORe2 = 1$

$e1 \neq 0$
 $e2 \neq 0 \rightarrow e1ORe2 = 1$

XOR

Exclusive OR

(Syntax) $e1XORe2$

(Condition) If the two data values e1 and e2 are zero and non-zero or non-zero and zero, the computed result is "1." Otherwise, it is "0."

(Explanation) $e1 = 0$
 $e2 = 0 \rightarrow e1XORe2 = 0$

$e1 \neq 0$
 $e2 = 0 \rightarrow e1XORe2 = 1$

$e1 = 0$
 $e2 \neq 0 \rightarrow e1XORe2 = 1$

$e1 \neq 0$
 $e2 \neq 0 \rightarrow e1XORe2 = 0$

NOT

Logical negation

(Syntax) $NOTe1$

(Condition) The result is the inverse of the status of data e1 (zero or non-zero).

(Explanation) $e1 = 0 \rightarrow NOTe1 = 1$
 $e1 \neq 0 \rightarrow NOTe1 = 0$

Equation Example**01-02OR03.GT.04**

Determines the OR of the computed results of "01-02" and "03.GT.04".

TLOG Computation

Only measured values and computed values can be used in TLOG computation. In the explanation below, e1 is used to represent a measurement or computation channel. You cannot specify an equation that contains a computing element inside e1. In addition, only one TLOG computation can be specified in a single computing equation.

TLOG.MAX()

Maximum value

(Syntax) TLOG.MAX(e1)

(Condition) Determines the maximum value of channel e1.

TLOG.MIN()

Minimum value

(Syntax) TLOG.MIN(e1)

(Condition) Determines the minimum value of channel e1.

TLOG.AVE()

Average value

(Syntax) TLOG.AVE(e1)

(Condition) Determines the average value of channel e1.

TLOG.SUM()

Sum value

(Syntax) TLOG.SUM(e1)

(Condition) Determines the sum of channel e1.

TLOG.P-P()

Maximum – minimum value

(Syntax) TLOG.P-P(e1)

(Condition) Determines the maximum – minimum value of channel e1.

Equation Example

TLOG.MAX(01) + K01*SQR(02)

Examples of Equations That Are Not Allowed

TLOG.AVE(01) + TLOG.AVE(02)

Reason: TLOG appears twice in one equation.

TLOG.AVE(ABS(01))

Reason: A computing element is used inside the parentheses.

9.3 Setting the Unit

This section explains the details of setting the unit on computation channels.

Procedure

1. Hold down the **MENU** key for 3 seconds to enter Setting mode.
2. Press the $\nabla\Delta$ key or **SHIFT** + $\nabla\Delta$ key to select **Math** and then press the \leftarrow key.
3. Press the $\nabla\Delta$ key or **SHIFT** + $\nabla\Delta$ key to select **Unit** and then press the \leftarrow key.
4. Set each item and press the \leftarrow key.
Use the $\nabla\Delta$ key or **SHIFT** + $\nabla\Delta$ key to select values.
For the procedure on how to enter values or characters, see section 4.2.
If you press the **ESC** key in the middle of the operation, the settings entered up to then are cancelled, and the display returns to a higher level menu.
5. When the **Setting complete** screen appears, do either of the following:
Press the \leftarrow key to set other channels.
If you are done, press the **ESC** key.
6. Hold down the **MENU** key for 3 seconds to return to Operation mode.

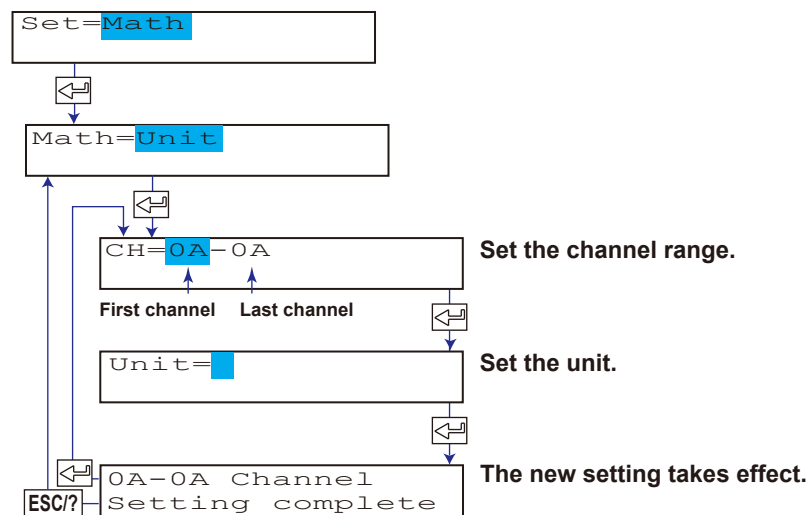

Explanation

Characters That Can Be Used for Units

Set the unit using up to 6 characters.

The available characters are as follows:

Alphabet, numbers, symbols (% , # , ° , @ , + , - , * , / , (,) , μ , Ω , ² , ³ , .), and space

9.4 Setting the Constants Used in Equations

This section explains the details of setting constants to be used in computing equations.

Procedure

1. Hold down the **MENU** key for 3 seconds to enter Setting mode.
2. Press the $\nabla\Delta$ key or **SHIFT** + $\nabla\Delta$ key to select **Math** and then press the \leftarrow key.
3. Press the $\nabla\Delta$ key or **SHIFT** + $\nabla\Delta$ key to select **Constant** and then press the \leftarrow key.
4. Set each item and press the \leftarrow key.
Use the $\nabla\Delta$ key or **SHIFT** + $\nabla\Delta$ key to select values.
For the procedure on how to enter values or characters, see section 4.2.
If you press the **ESC** key in the middle of the operation, the settings entered up to then are cancelled, and the display returns to a higher level menu.
5. When the **Setting complete** screen appears, do either of the following:
Press the \leftarrow key to set other channels.
If you are done, press the **ESC** key.
6. Hold down the **MENU** key for 3 seconds to return to Operation mode.

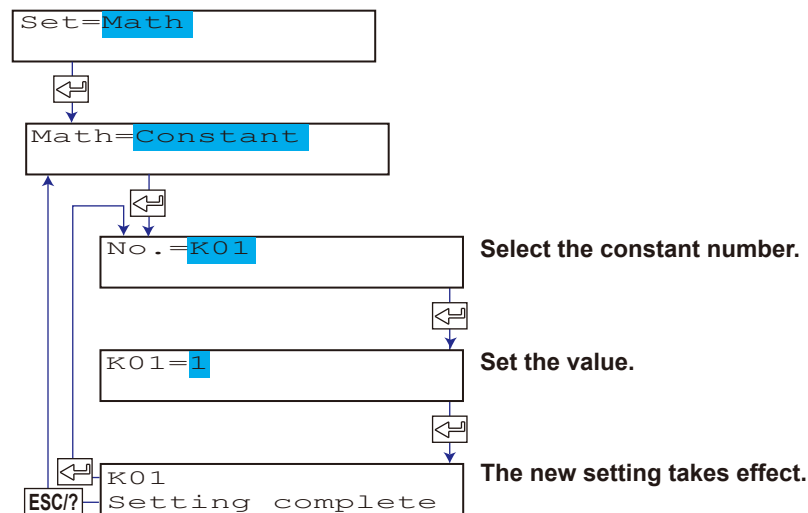

Explanation

Constant

Up to 30 constants can be registered. Enter the values as K01 to K30 in the equations. Set the constants in the range shown below. The maximum number of significant digits is 5.
-9.9999E+29 to -1.0000E-30, 0, 1.0000E-30 to 9.9999E+29

9.5 Setting the Alarm

This section explains the details of setting alarms for each computation channel. If you change the computing equation or the recording span, set the alarm again.

Procedure

1. Hold down the **MENU** key for 3 seconds to enter Setting mode.
2. Press the $\nabla\Delta$ key or **SHIFT + $\nabla\Delta$** key to select **Math** and then press the \leftarrow key.
3. Press the $\nabla\Delta$ key or **SHIFT + $\nabla\Delta$** key to select **Alarm** and then press the \leftarrow key.
4. Set each item and press the \leftarrow key.
Use the $\nabla\Delta$ key or **SHIFT + $\nabla\Delta$** key to select values.
For the procedure on how to enter values or characters, see section 4.2.
If you press the **ESC** key in the middle of the operation, the settings entered up to then are cancelled, and the display returns to a higher level menu.
5. When the **Setting complete** screen appears, do either of the following:
Press the \leftarrow key to set other channels.
If you are done, press the **ESC** key.
6. Hold down the **MENU** key for 3 seconds to return to Operation mode.

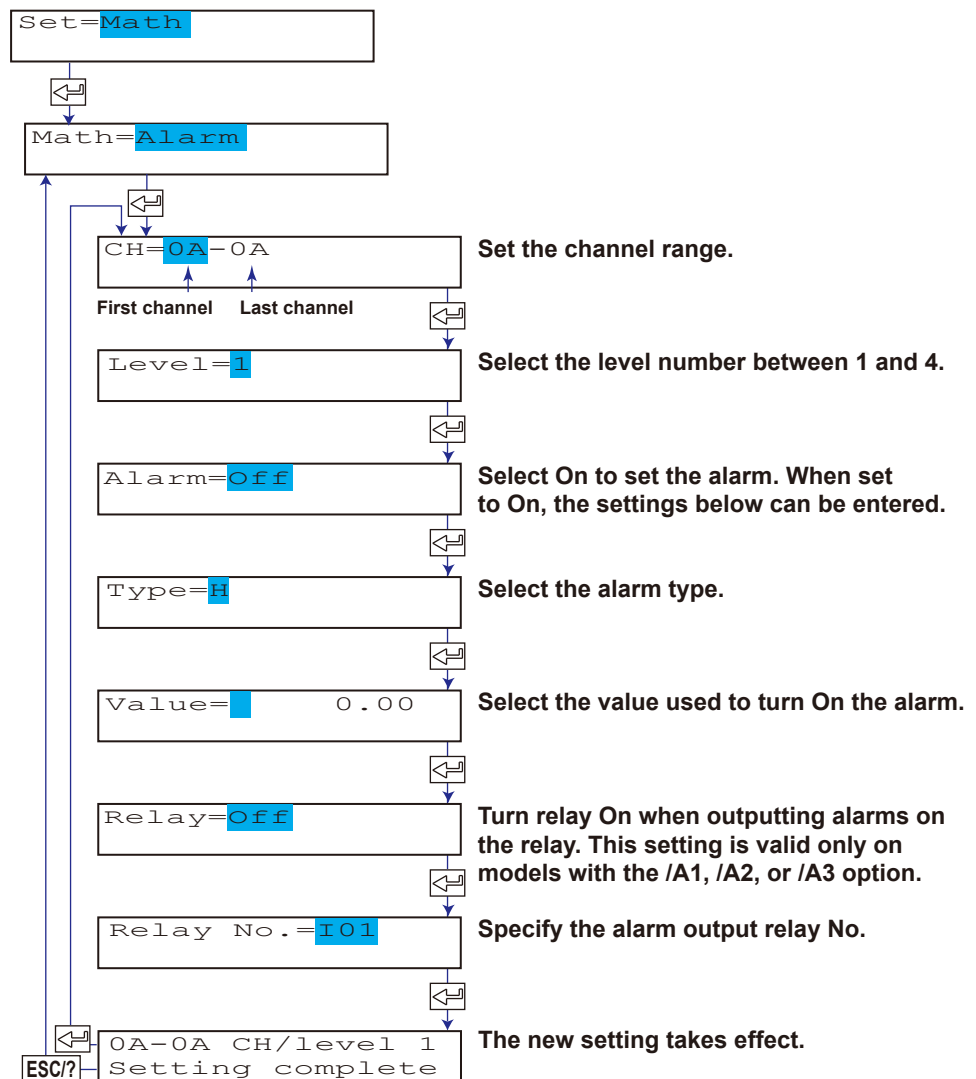

Explanation

Alarm Type

Symbol	Name
H	High limit alarm
L	Low limit alarm
T	Delay high limit alarm*
t	Delay low limit alarm*

* Selectable only when the alarm delay function is enabled. See section 7.15.

If delay high limit alarm or delay low limit alarm is specified, set the alarm delay time.

<Related Topics>

Setting the delay time of the delay high limit alarm or delay low limit alarm: Section 9.11

Enabling the alarm delay function: Section 7.15

Setting the alarm hysteresis: Section 7.1

Alarm Value

Can be set to a value in the range of -9999999 to 99999999 excluding the decimal (-9999999 to 99999999 is the displayable range).

Relay No.

The selectable relay numbers are listed below.

I01 and I02 on the /A1 option

I01, I02, I03, and I04 on the /A2 option

I01, I02, I03, I04, I05, and I06 on the /A3 option

9.6 Specifying the Timer Used in Statistical Calculations (TLOG)

On channels that perform statistical calculation (TLOG), the timer for determining the interval is specified. The sum scale is also specified when using statistical calculation. The timer is also used for the periodic printout of computed values.

Procedure

1. Hold down the **MENU** key for 3 seconds to enter Setting mode.
2. Press the $\nabla\Delta$ key or **SHIFT + $\nabla\Delta$** key to select **Math** and then press the \leftarrow key.
3. Press the $\nabla\Delta$ key or **SHIFT + $\nabla\Delta$** key to select **TLOG** and then press the \leftarrow key.
4. Set each item and press the \leftarrow key.
Use the $\nabla\Delta$ key or **SHIFT + $\nabla\Delta$** key to select values.
For the procedure on how to enter values or characters, see section 4.2.
If you press the **ESC** key in the middle of the operation, the settings entered up to then are cancelled, and the display returns to a higher level menu.
5. When the **Setting complete** screen appears, do either of the following:
Press the \leftarrow key to set other channels.
If you are done, press the **ESC** key.
6. Hold down the **MENU** key for 3 seconds to return to Operation mode.

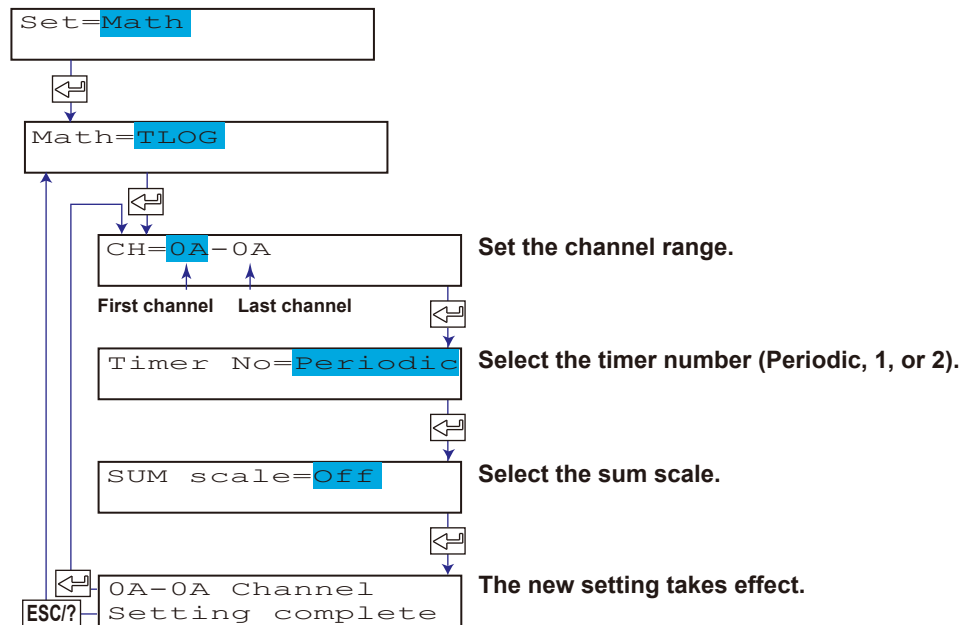

9.6 Specifying the Timer Used in Statistical Calculations (TLOG)

Explanation

Timer No.

There are three timers.

Periodic: The timer for determining the periodic printout interval. The computed result is printed every interval, and the computed TLOG value is reset.

1: The timer of timer No. 1. Specify whether the computed value is printed every interval and whether to reset the computed value.

2: The timer of timer No. 2. Specify whether the computed value is printed every interval and whether to reset the computed value.

• Timer operation

The table below shows how each timer operates.

Item	Timer #	Periodic	1 and 2*
Application		Periodic	TLOG computation
Target channel		Measurement and computation channels	Computation channels
Timer mode**		Absolute time mode	Absolute or relative time mode
Reset computed TLOG value		Yes	Yes/No selectable
Print when computation stops		No	Yes

* For the timer 1 and 2 settings, see section 9.12.

** Absolute time mode: Keeps time from the reference time.

Relative time mode: Starts the time in sync with the starting of the computation.

SUM scale

Set the sum scale when using statistical calculation (TLOG.SUM).

For the definition of the term "sum scale," see page 7-14.

Off: Simply sums the computed values.

/s: Sums by converting the computed values to a value over 1 second.

/min: Sums by converting the computed values to a value over 1 minute.

/h: Sums by converting the computed values to a value over 1 hour.

/day: Sums by converting the computed values to a value over 1 day.

<Related Topics> Setting the periodic printout timer: Section 7.8

Setting Timer 1 and Timer 2: Section 9.12

9.7 Setting Recording Zones for Each Channel (Zone Recording)

This section explains the details of setting the recording zone for each computation channel.

Procedure

1. Hold down the **MENU** key for 3 seconds to enter Setting mode.
2. Press the $\nabla\Delta$ key or **SHIFT** + $\nabla\Delta$ key to select **Math** and then press the \leftarrow key.
3. Press the $\nabla\Delta$ key or **SHIFT** + $\nabla\Delta$ key to select **Aux** and then press the \leftarrow key.
4. Press the $\nabla\Delta$ key or **SHIFT** + $\nabla\Delta$ key to select **Zone** and then press the \leftarrow key.
5. Set each item and press the \leftarrow key.
Use the $\nabla\Delta$ key or **SHIFT** + $\nabla\Delta$ key to select values.
For the procedure on how to enter values or characters, see section 4.2.
If you press the **ESC** key in the middle of the operation, the settings entered up to then are cancelled, and the display returns to a higher level menu.
6. When the **Setting complete** screen appears, do either of the following:
Press the \leftarrow key to set other channels.
If you are done, press the **ESC** key.
7. Hold down the **MENU** key for 3 seconds to return to Operation mode.

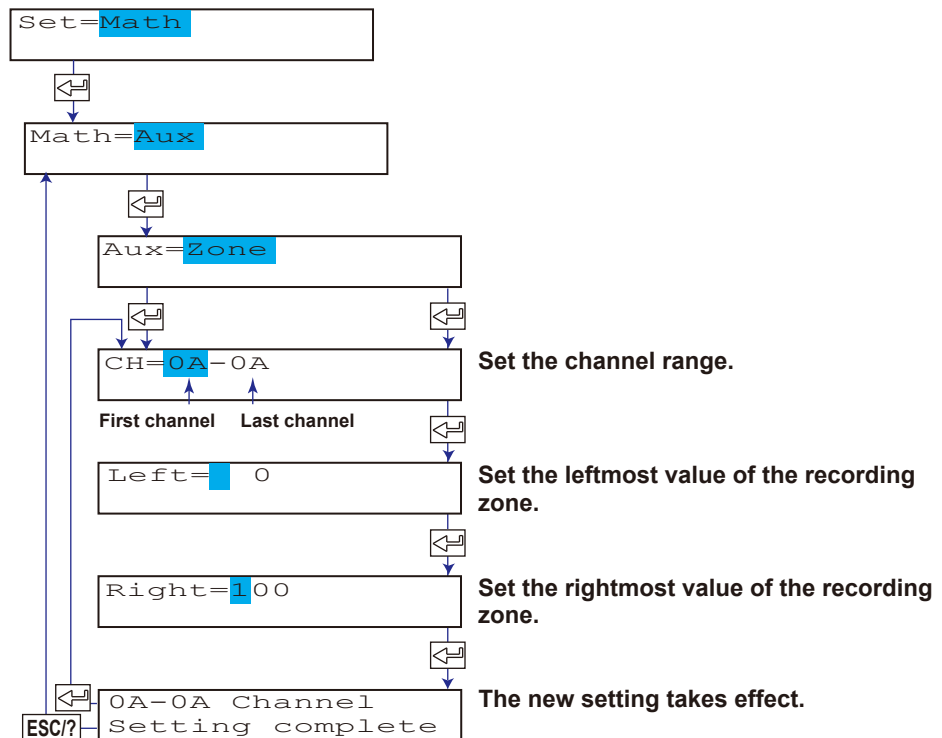

Explanation

Zone

The recording zone can be set in the following range.

Leftmost position: 0 mm to 95 mm

Rightmost position: 5 mm to 100 mm

Set a larger value for the rightmost position than the leftmost position.

Set at least 5 mm for the zone width.

Note

If the zone is set to a value less than 40 mm, scale printout of periodic printout cannot be executed.

9.8 Setting the Partial Expanded Recording

This section explains the details of expanding a section of the recording range. If you change the computing equation or the recording span, set the partial expanded recording again.

Procedure

1. Hold down the **MENU** key for 3 seconds to enter Setting mode.
2. Press the $\nabla\Delta$ key or **SHIFT** + $\nabla\Delta$ key to select **Math** and then press the \leftarrow key.
3. Press the $\nabla\Delta$ key or **SHIFT** + $\nabla\Delta$ key to select **Aux** and then press the \leftarrow key.
4. Press the $\nabla\Delta$ key or **SHIFT** + $\nabla\Delta$ key to select **Partial** and then press the \leftarrow key.
5. Set each item and press the \leftarrow key.
Use the $\nabla\Delta$ key or **SHIFT** + $\nabla\Delta$ key to select values.
For the procedure on how to enter values or characters, see section 4.2.
If you press the **ESC** key in the middle of the operation, the settings entered up to then are cancelled, and the display returns to a higher level menu.
6. When the **Setting complete** screen appears, do either of the following:
Press the \leftarrow key to set other channels.
If you are done, press the **ESC** key.
7. Hold down the **MENU** key for 3 seconds to return to Operation mode.

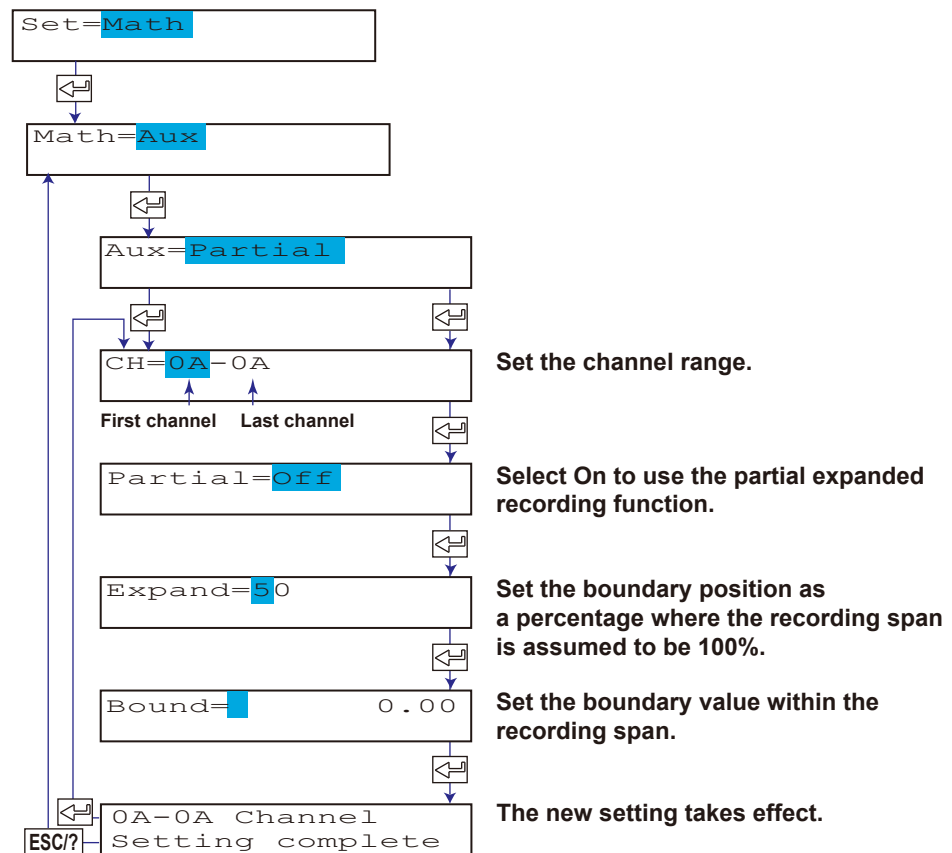

<Related Topics> Enabling the partial expanded recording function: Section 7.13

9.9 Turning Trend Recording (Dot Model) and Periodic Printout (Including the Printout Using the TLOG Timer) ON/OFF for Each Channel

This section explains the details of setting the trend recording and periodic printout for each computation channel.

The following settings can be entered for each channel.

- Turn trend recording ON/OFF (dot model only).
- Turn the printing of computed values ON/OFF during periodic printout.

Procedure

1. Hold down the **MENU** key for 3 seconds to enter Setting mode.
2. Press the $\nabla\Delta$ key or **SHIFT** + $\nabla\Delta$ key to select **Math** and then press the \leftarrow key.
3. Press the $\nabla\Delta$ key or **SHIFT** + $\nabla\Delta$ key to select **Aux** and then press the \leftarrow key.
4. Press the $\nabla\Delta$ key or **SHIFT** + $\nabla\Delta$ key to select **Print out** and then press the \leftarrow key.
5. Set each item and press the \leftarrow key.
Use the $\nabla\Delta$ key or **SHIFT** + $\nabla\Delta$ key to select values.
For the procedure on how to enter values or characters, see section 4.2.
If you press the **ESC** key in the middle of the operation, the settings entered up to then are cancelled, and the display returns to a higher level menu.
6. When the **Setting complete** screen appears, do either of the following:
Press the \leftarrow key to set other channels.
If you are done, press the **ESC** key.
7. Hold down the **MENU** key for 3 seconds to return to Operation mode.

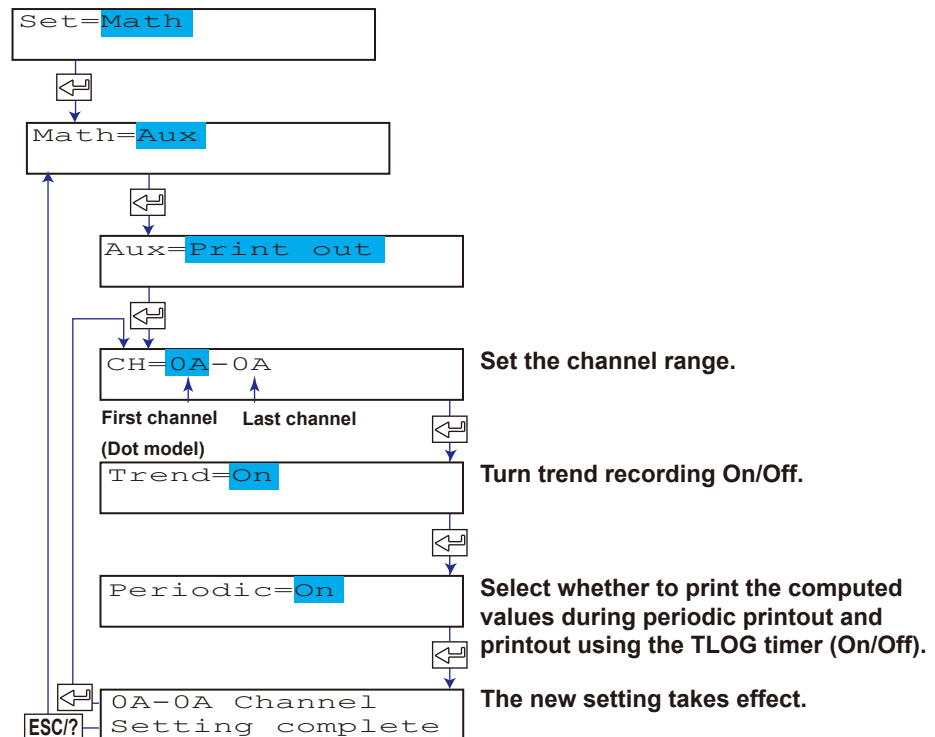

Explanation

Periodic Printout

- On:** Prints the computed values (instantaneous values or report data) of the specified channel during periodic printout.
- Off:** Does not print the channels and computed values during periodic printout.

9.10 Setting Tags on Channels

This section explains the details of setting the tag on computation channels.

Procedure

1. Hold down the **MENU** key for 3 seconds to enter Setting mode.
2. Press the $\nabla\Delta$ key or **SHIFT** + $\nabla\Delta$ key to select **Math** and then press the \leftarrow key.
3. Press the $\nabla\Delta$ key or **SHIFT** + $\nabla\Delta$ key to select **Aux** and then press the \leftarrow key.
4. Press the $\nabla\Delta$ key or **SHIFT** + $\nabla\Delta$ key to select **Tag** and then press the \leftarrow key.
5. Set each item and press the \leftarrow key.
Use the $\nabla\Delta$ key or **SHIFT** + $\nabla\Delta$ key to select values.
For the procedure on how to enter values or characters, see section 4.2.
If you press the **ESC** key in the middle of the operation, the settings entered up to then are cancelled, and the display returns to a higher level menu.
6. When the **Setting complete** screen appears, do either of the following:
Press the \leftarrow key to set other channels.
If you are done, press the **ESC** key.
7. Hold down the **MENU** key for 3 seconds to return to Operation mode.

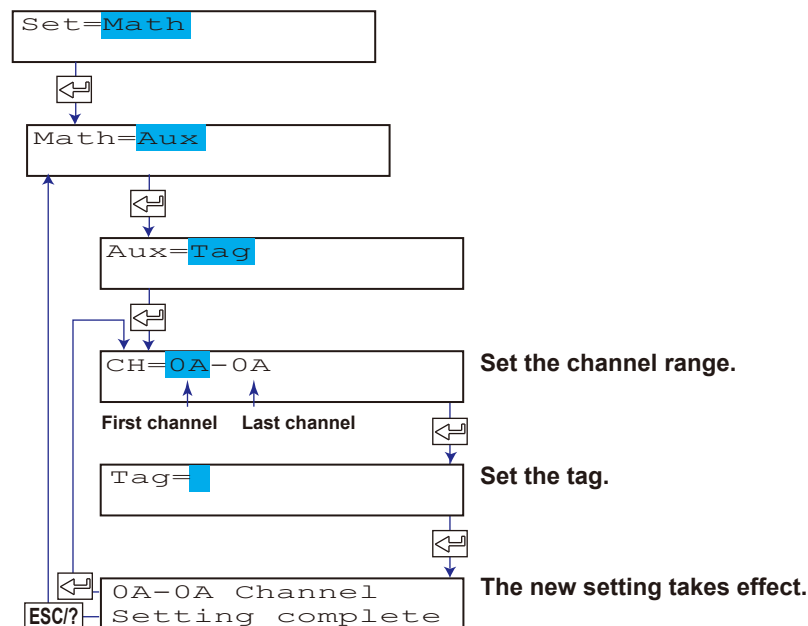

Explanation

Characters That Can Be Used for Tags

Set the tag using up to 7 characters.

The available characters are as follows:

Alphabet, numbers, symbols (% , # , ° , @ , + , - , * , / , (,) , μ , Ω , ² , ³ , .), and space

<Related Topics> Printing tags in place of channel numbers: Section 7.7

Displaying tags in place of channel numbers: Section 8.2

9.11 Setting the Alarm Delay Duration

This section explains the details of setting the duration of the delay high limit and delay low limit alarms.

Procedure

1. Hold down the **MENU** key for 3 seconds to enter Setting mode.
2. Press the $\nabla\Delta$ key or **SHIFT** + $\nabla\Delta$ key to select **Math** and then press the \leftarrow key.
3. Press the $\nabla\Delta$ key or **SHIFT** + $\nabla\Delta$ key to select **Aux** and then press the \leftarrow key.
4. Press the $\nabla\Delta$ key or **SHIFT** + $\nabla\Delta$ key to select **Alm delay T** and then press the \leftarrow key.
5. Set each item and press the \leftarrow key.
Use the $\nabla\Delta$ key or **SHIFT** + $\nabla\Delta$ key to select values.
For the procedure on how to enter values or characters, see section 4.2.
If you press the **ESC** key in the middle of the operation, the settings entered up to then are cancelled, and the display returns to a higher level menu.
6. When the **Setting complete** screen appears, do either of the following:
Press the \leftarrow key to set other channels.
If you are done, press the **ESC** key.
7. Hold down the **MENU** key for 3 seconds to return to Operation mode.

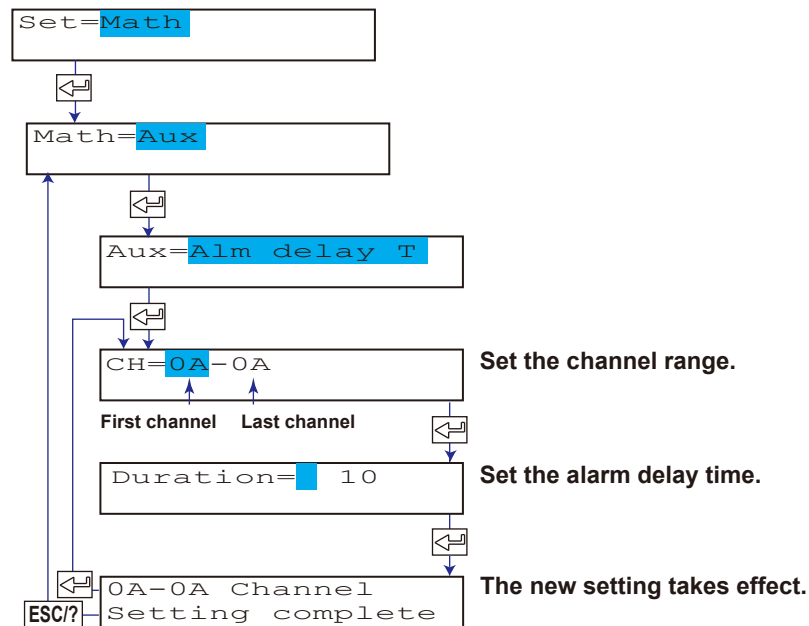

Explanation

Duration

The duration can be set to a value in the range of 1 to 3600 s.

However, if the scan interval on the dot model is 2.5 s, the actual duration is an integer multiple of 2.5 s. If the set value is not equal to an integer multiple of 2.5 s, the duration is the smallest integer multiple of 2.5 s greater than the set value.

Example: The actual duration for 1 s and 2 s is 2.5 s.

<Related Topics> Enabling the alarm delay function: Section 7.15

9.12 Setting the Timer Used in TLOG Computation and Periodic Printout

This section explains the details of setting the timer used in TLOG computation and periodic printout.

Basic Setting mode cannot be entered when recording is in progress or when computation is in progress on models with the computation function (/M1 option).

Procedure

Changing the Settings

1. Hold down the **MENU** key for 3 seconds to enter Setting mode.
2. Hold down the **▽△** and **◀▶** keys simultaneously for 3 seconds to enter Basic Setting mode.
3. Press the **▽△** key or **SHIFT + ▽△** key to select **Math** and then press the **↵** key.
4. Press the **↵** key with **Timer (TLOG)** shown on the screen.
5. Set each item and press the **↵** key.
Use the **▽△** key or **SHIFT + ▽△** key to select values.
For the procedure on how to enter values or characters, see section 4.2.
If you press the **ESC** key in the middle of the operation, the settings entered up to then are cancelled, and the display returns to a higher level menu.
6. When the **Setting complete** screen appears, do either of the following:
To correct the setting, press the **↵** key.
If you are done, press the **ESC** key.

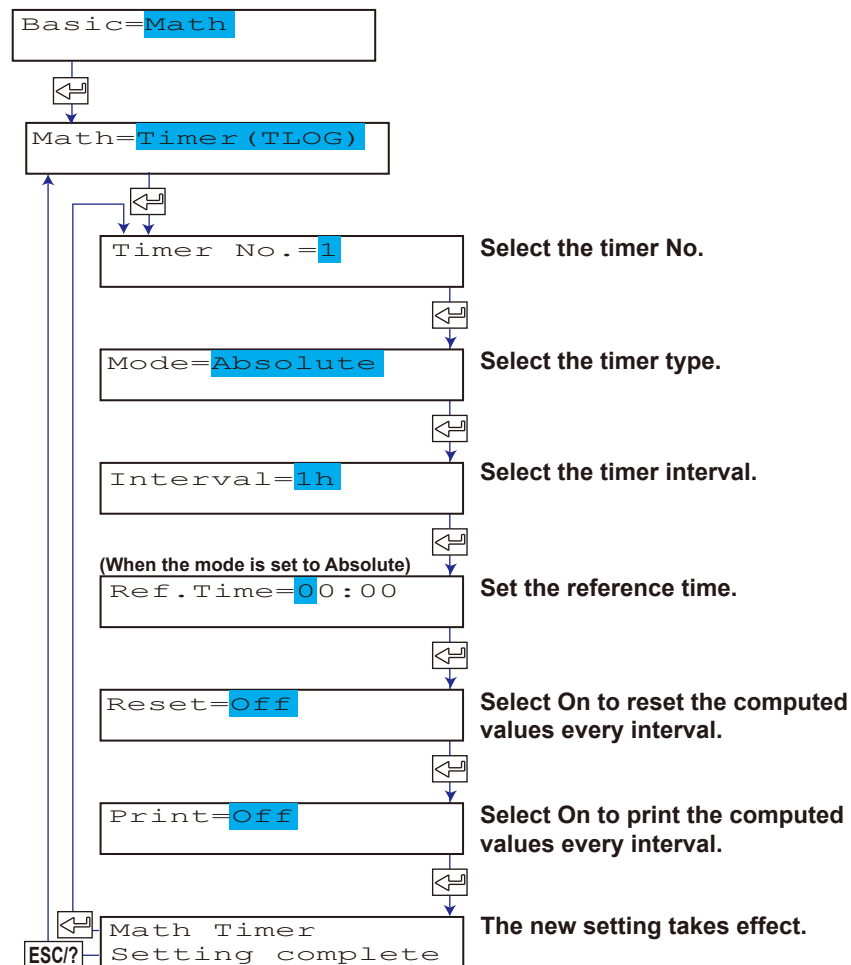

Applying the Changes and Returning to Operation Mode

Press the $\nabla\Delta$ key or **SHIFT** + $\nabla\Delta$ key to select **End** and then press the \leftarrow key. Press the $\nabla\Delta$ key to select **Store** and then press the \leftarrow key. The changes are applied, and the screen returns to Operation mode. If you select **Abort** and press the \leftarrow key, the changes are discarded, and the screen returns to Operation mode. Press the **ESC** key to return to the **Basic=** screen.

Explanation**Timers**

Timer features

- The timer determines the interval used to calculate the report data (the average, minimum, maximum, sum value), etc.
- The timer is also used to set the interval at which the computed values are printed on the chart paper.

Number of Timers

There are two timers: Timer No. 1 and 2. The timer that is used can be set for each channel.

Timer Type

There are two timer modes, absolute time mode and relative time mode. For absolute time mode timers, set the reference time and interval; for relative time mode timers, set the interval.

- **Absolute (Absolute Time Mode)**

After the computation is started, the timer times out at the times determined by the reference time (on the hour) and the interval. The **Ref. Time** (reference time) is set on the hour (00 to 23).

Example 1: Reference time: 14:00

Interval: 12h

The timeout times are hour 2 and hour 14.

Example 2: Reference time: 00:00

Interval: 10min

The timeout times are 0 hour, 0 hour 10 min, 0 hour 20 min, ... 23 hour 40 min, and 23 hour 50 min. For example, if computation is started at 9 hour 36 min, the timeout times are 09 hour 40 min, 09 hour 50 min, 10 hour, and so on.

- **Relative (Relative Time Mode)**

The clock is started in sync with the starting of the computation, and the timer times out every specified interval. In this mode, the timer and the clock stop when a power failure occurs.

Example: Interval: 00:15

The timer times out every 15 minutes after the computation is started.

- **Off**

If Off is selected, the TLOG computation continues, but reset and printout are not performed. To reset computed result, use the remote control function (/R1 option) or carry it out manually (using the FUNC key).

Interval

Select from 10, 12, 15, 20, 30min, 1, 2, 3, 4, 6, 8, 12, and 24h.

<Related Topics> Setting the timer to be used for each channel: Section 9.6
 Resetting the computation remotely: Section 7.18
 Resetting the computation manually: Section 9.1

9.12 Setting the Timer Used in TLOG Computation and Periodic Printout

Reset

Selects whether to reset the TLOG computed value at each interval. The figure below illustrates the reset operation for sum computation (TLOG.SUM).

Example: TLOG.SUM computation

Timer timeout

Reset: On

Reset: Off

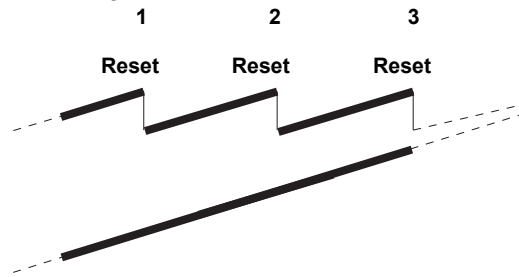

When reset is ON, the sum value is calculated over each interval. When set to Off, the sum value from computation start is calculated.

Print

On: Prints the computed value every interval specified by the timer. Computation channels set to Off do not apply.

Off: Does not print.

9.13 Changing the Channel Recording Color (Dot Model)

This section explains the details of changing the recording colors of computation channels.

Basic Setting mode cannot be entered when recording is in progress or when computation is in progress on models with the computation function (/M1 option).

Procedure

Changing the Settings

1. Hold down the **MENU** key for 3 seconds to enter Setting mode.
2. Hold down the **▽△** and **◀▶** keys simultaneously for 3 seconds to enter Basic Setting mode.
3. Press the **▽△** key or **SHIFT + ▽△** key to select **Math** and then press the **↵** key.
4. Press the **▽△** key or **SHIFT + ▽△** key to select **Color** and then press the **↵** key.
5. Set each item and press the **↵** key.
Use the **▽△** key or **SHIFT + ▽△** key to select values.
For the procedure on how to enter values or characters, see section 4.2.
If you press the **ESC** key in the middle of the operation, the settings entered up to then are cancelled, and the display returns to a higher level menu.
6. When the **Setting complete** screen appears, do either of the following:
To correct the setting, press the **↵** key.
If you are done, press the **ESC** key.

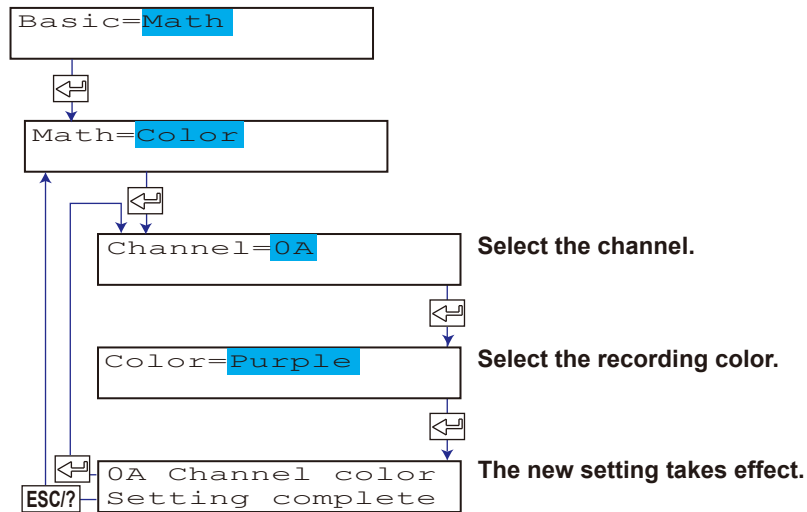

Applying the Changes and Returning to Operation Mode

Press the **▽△** key or **SHIFT + ▽△** key to select **End** and then press the **↵** key. Press the **▽△** key to select **Store** and then press the **↵** key. The changes are applied, and the screen returns to Operation mode. If you select **Abort** and press the **↵** key, the changes are discarded, and the screen returns to Operation mode. Press the **ESC** key to return to the **Basic=** screen.

Explanation

Color

This section explains the details of changing the recording colors of computation channels.

The default values are as follows:

Purple: channel 0A, 0G, Red: channel 0B, 0J, Green: channel 0C, 0K,
Blue: channel 0D, 0M, Brown: channel 0E, 0N, Black: channel 0F, 0P

9.14 Changing the Channel Assignments of Recording Pens (Pen Model)

Measurement channels and computation channels can be arbitrarily assigned to recording pens.

Basic Setting mode cannot be entered when recording is in progress or when computation is in progress on models with the computation function (/M1 option).

Procedure

Changing the Settings

1. Hold down the **MENU** key for 3 seconds to enter Setting mode.
2. Hold down the **▽△** and **◀▶** keys simultaneously for 3 seconds to enter Basic Setting mode.
3. Press the **▽△** key or **SHIFT + ▽△** key to select **Math** and then press the **↵** key.
4. Press the **▽△** key or **SHIFT + ▽△** key to select **Output pen** and then press the **↵** key.
5. Set each item and press the **↵** key.
Use the **▽△** key or **SHIFT + ▽△** key to select values.
For the procedure on how to enter values or characters, see section 4.2.
If you press the **ESC** key in the middle of the operation, the settings entered up to then are cancelled, and the display returns to a higher level menu.
6. When the **Setting complete** screen appears, do either of the following:
To correct the setting, press the **↵** key.
If you are done, press the **ESC** key.

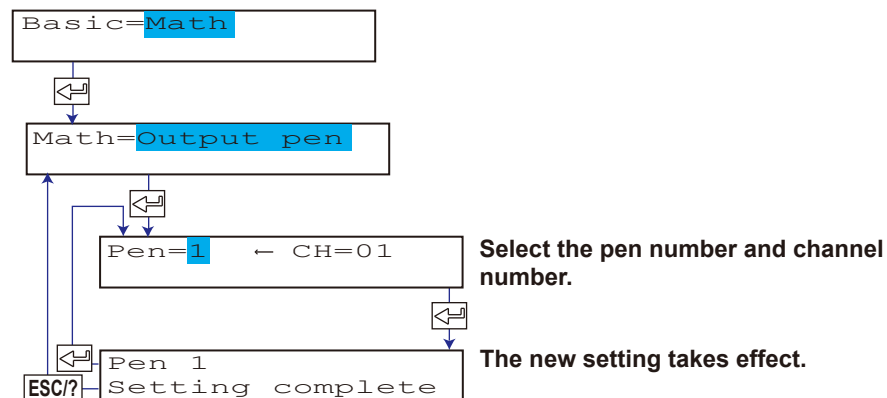

Applying the Changes and Returning to Operation Mode

Press the **▽△** key or **SHIFT + ▽△** key to select **End** and then press the **↵** key. Press the **▽△** key to select **Store** and then press the **↵** key. The changes are applied, and the screen returns to Operation mode. If you select **Abort** and press the **↵** key, the changes are discarded, and the screen returns to Operation mode. Press the **ESC** key to return to the **Basic=** screen.

Explanation

Output pen

Measurement channels and computation channels can be arbitrarily assigned to recording pens.

The default values are as follows:

- Pen No. 1 (red): Channel 01
- Pen No. 2 (green): Channel 02
- Pen No. 3 (Blue): Channel 03
- Pen No. 4 (violet): channel 04

9.15 Changing the Type of Report Data Printed in Periodic Printout

This section explains the details of selecting the type of report (the average, minimum, maximum, or sum) printed in periodic printout.

To print the report data during periodic printout, set the type of data to be printed to report (see section 7.8).

Basic Setting mode cannot be entered when recording is in progress or when computation is in progress on models with the computation function (/M1 option).

Procedure

Changing the Settings

1. Hold down the **MENU** key for 3 seconds to enter Setting mode.
2. Hold down the $\nabla\Delta$ and $\triangleleft\triangleright$ keys simultaneously for 3 seconds to enter Basic Setting mode.
3. Press the $\nabla\Delta$ key or **SHIFT** + $\nabla\Delta$ key to select **Math** and then press the \triangleleft key.
4. Press the $\nabla\Delta$ key or **SHIFT** + $\nabla\Delta$ key to select **Print2** and then press the \triangleleft key.
5. Set each item and press the \triangleleft key.
Use the $\nabla\Delta$ key or **SHIFT** + $\nabla\Delta$ key to select values.
For the procedure on how to enter values or characters, see section 4.2.
If you press the **ESC** key in the middle of the operation, the settings entered up to then are cancelled, and the display returns to a higher level menu.
6. When the **Setting complete** screen appears, do either of the following:
To correct the setting, press the \triangleleft key.
If you are done, press the **ESC** key.

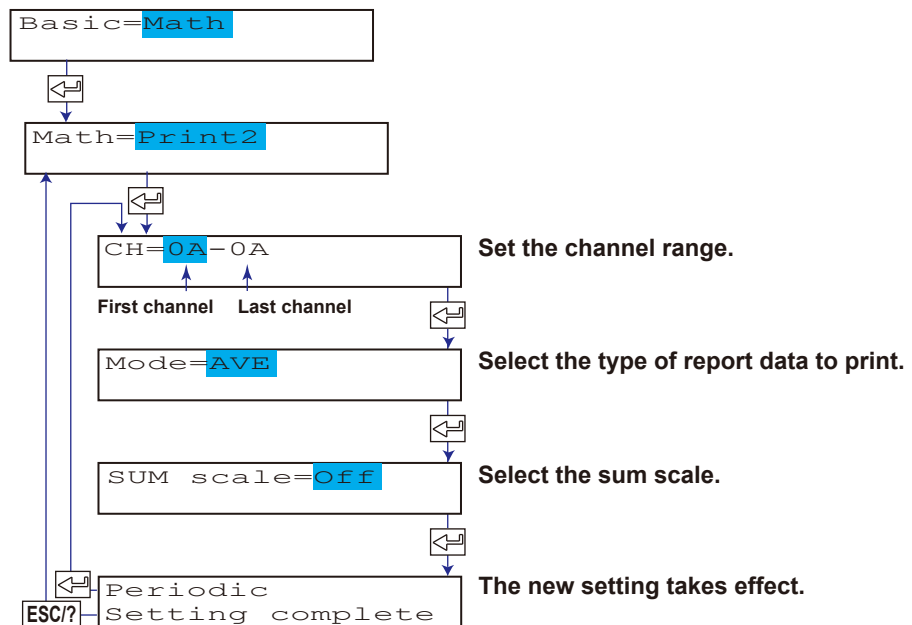

Applying the Changes and Returning to Operation Mode

Press the $\nabla\Delta$ key or **SHIFT** + $\nabla\Delta$ key to select **End** and then press the \triangleleft key. Press the $\nabla\Delta$ key to select **Store** and then press the \triangleleft key. The changes are applied, and the screen returns to Operation mode. If you select **Abort** and press the \triangleleft key, the changes are discarded, and the screen returns to Operation mode. Press the **ESC** key to return to the **Basic=** screen.

Explanation

Mode

Sets the type of report data to be printed.

AVE: Prints the average value over the interval.

MIX: Prints the minimum, maximum, and average values over the interval.

SUM: Prints the sum value over the interval. If SUM is selected, set the sum scale.

MIN: Prints the minimum value over the interval.

MAX: Prints the maximum value over the interval.

INST: Prints the instantaneous value.

SUM scale

Set this item only when SUM is selected.

For the definition of the term "sum scale," see page 7-14.

Off: Simply sums the computed values.

/s: Sums by converting the computed values to a value over 1 second.

/min: Sums by converting the computed values to a value over 1 minute.

/h: Sums by converting the computed values to a value over 1 hour.

/day: Sums by converting the computed values to a value over 1 day.

<Related Topics> Setting the periodic printout interval and the type of data to be printed: Section 7.8

9.16 Setting the Bar Graph Display Mode

This section explains the details of setting the bar graph display mode. Basic Setting mode cannot be entered when recording is in progress or when computation is in progress on models with the computation function (/M1 option).

Procedure

Changing the Settings

1. Hold down the **MENU** key for 3 seconds to enter Setting mode.
2. Hold down the **▽△** and **◀▶** keys simultaneously for 3 seconds to enter Basic Setting mode.
3. Press the **▽△** key or **SHIFT + ▽△** key to select **Math** and then press the **↵** key.
4. Press the **▽△** key or **SHIFT + ▽△** key to select **Bar graph** and then press the **↵** key.
5. Set each item and press the **↵** key.
Use the **▽△** key or **SHIFT + ▽△** key to select values.
For the procedure on how to enter values or characters, see section 4.2.
If you press the **ESC** key in the middle of the operation, the settings entered up to then are cancelled, and the display returns to a higher level menu.
6. When the **Setting complete** screen appears, do either of the following:
Press the **↵** key to set other channels.
If you are done, press the **ESC** key.

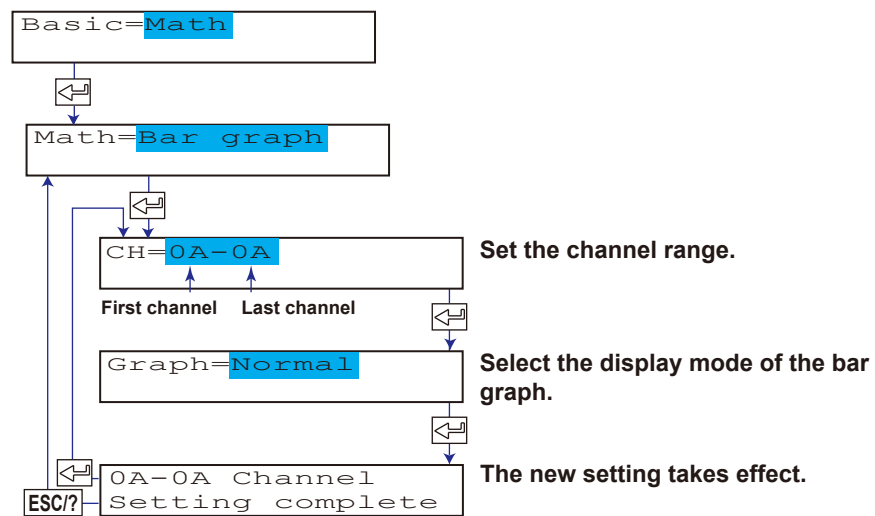

Applying the Changes and Returning to Operation Mode

Press the **▽△** key or **SHIFT + ▽△** key to select **End** and then press the **↵** key. Press the **▽△** key to select **Store** and then press the **↵** key. The changes are applied, and the screen returns to Operation mode. If you select **Abort** and press the **↵** key, the changes are discarded, and the screen returns to Operation mode. Press the **ESC** key to return to the **Basic=** screen.

Explanation

Graph

Normal: Sets the base point of the bar graph to the left or right of the recording span whichever is smaller in value.

Center: Sets the base point of the bar graph to the 50% position of the recording span.

Explanation**Error**

Specifies how to display or print the computed result when computation errors occur.

+Over: Set to +over. Displayed/Printed as "+Over."

–Over: Set to –over. Displayed/Printed as "–Over."

Computation that result in errors

- $x/0$
- $SQR(-x)$
- $LOG(-x)$
- When a channel set to Skip is included in the equation

Over

Selects the procedure when an "over" value* is input for TLOG.SUM or TLOG.AVE computation.

- * An "over" value on a measurement channel refers to +Over or –Over. See section 12.4. An "over" value on a computation channel refers to a value that is less than or equal to –100000000 or greater than or equal to 100000000 excluding the decimal.

Skip: The "over" value is not used in the computation.

Limit: The following limit value is used for the computation.

Channel	Limit Value
Measurement channel	<ul style="list-style-type: none"> • For scaling (1-5V, scaling, and square root) –Over: –31500, +Over: 31500 (excluding the decimal) • For input types other than scaling –Over: The minimum measurable value at the specified range type (Example: –2.000 at 2 V range) +Over: The maximum measurable value at the specified range type (Example: 2.000 at 2 V range)
Computation channel	–Over: –100000000, +Over: 100000000 (excluding the decimal)

Blank

10.1 A List of Error Messages

There are cases in which error codes and messages are displayed on the screen during operation. The error messages and their description are listed below.

Setting Errors

Code	Message	Explanation/Countermeasures
1	System error.	Contact your nearest YOKOGAWA dealer.
2	Incorrect date or time setting.	Check the setting.
3	A disabled channel is selected.	The channel does not exist.
4	Incorrect function parameter.	Incorrect communication parameter.
5	The input numerical value exceeds the set range.	–
6	Incorrect input character string.	The entered character cannot be used.
7	Too many characters.	–
8	Incorrect input mode.	Incorrect range mode (Volt, TC, Scale, etc.) setting.
9	Incorrect input range code.	Incorrect range type (2 V, R, PT100, etc.) setting.
10	Format error.	Incorrect character string format.
11	Range settings are not same within the selected channels.	Channels whose range differs cannot be set simultaneously.
12	An invalid characters.	Contains an invalid character.
13	Ref. CH error.	Specify a channel whose range is set to voltage, TC, or RTD for the reference channel.
15	Too many characters for printout.	Too many characters in the message printout including measured/computed values.
16	Too many characters for message.	Cannot enter a setting that exceeds the message string (16 characters).
21	Cannot set an alarm for a SKIPPED channel.	–
22	The upper and lower span limits are equal.	This is not allowed.
23	The upper and lower scale limits are equal.	This is not allowed.
24	The lower span limit is greater than the upper span limit.	–
25	The lower scale limit is greater than the upper scale limit.	–
26	Bias cannot be set to the SKIPPED channel.	–
27	Bias cannot be set to the DI channel.	–
30	The partial boundary value exceeds the range of the span.	–
31	Partial is invalid on the SKIPPED channel.	–
35	The upper and lower limits of the printing zone are equal.	Set the rightmost value of the zone – the leftmost value ≥ 5 mm.
36	The lower limit of the printing zone is greater than the upper limit.	Set the rightmost value of the zone – the leftmost value ≥ 5 mm.
37	The printing zone is narrower than the minimum width (5 mm).	Set the rightmost value of the zone – the leftmost value ≥ 5 mm.
38	Partial is invalid on the DI channel.	–
39	The bias and the calibration cannot be used simultaneously.	–
40	Datume value (1 \geq 2)	Set the correction point (measured value) of the first point less than that of the second point in the calibration correction.
41	Datume value (n-1 $>$ n)	Set the correction point (measured value) of the n-1 th point less than or equal to that of the n th point in the calibration correction.
42	Revise value (n-1 \geq n)	Set the correction value of the n-1 th point less than that of the n th point in the calibration correction.
47	All items in DISP menu parameters are set to SKIP.	–
48	Start = Finish.	The DST start time and end time cannot be set to the same time.
49	Invalid or missing DST time settings.	Since the time gains one hour when the DST starts, the set-up time does not exist.
61	There is no channel specified by the MATH expression.	Set a computation channel.
62	MATH expression grammar is incorrect.	Enter the equation correctly.
63	MATH expression sequence is incorrect.	Enter the equation correctly.

10.1 A List of Error Messages

Code	Message	Explanation/Countermeasures
64	MATH upper and lower span values are equal.	This is not allowed.
70	MATH constant description is incorrect.	Incorrect computation constant syntax.
71	The range of the MATH constant is exceeded.	–
72	MATH channel is turned off	–
81	All space or 'quit' string cannot be specified.	–
86	The key-lock release password is incorrect.	Enter the correct password.
87	This key is locked.	–
91	Password is incorrect.	Enter the correct password.
100	IP address doesn't belong to class A, B, or C.	–
101	The result of the masked IP address is all 0s or 1s.	–
102	SUBNET mask is incorrect.	Set a correct subnet mask.
103	The net part of default gateway is not equal to that of IP address.	Set the correct default gateway.
151	This action is invalid during calculation.	–
160	This action is invalid during chart end.	–
161	This action is invalid during pen hold.	–
162	Cannot set an number for a skipped data.	–
163	This action is invalid during record.	–
164	This action is invalid during manual printing.	–
165	This action is invalid during list printing.	–
166	This action is invalid during setup list printing.	–
167	This action is invalid during chart feed.	–
169	This action is invalid during ribbon hold.	–
170	This action is invalid during priority remote record.	Recording stop via communications or key operation cannot be accepted under the current settings. Perform the Stop using the remote control function.
171	This action is invalid during batch.	Cannot enter Basic Setting mode during header printout (until End printout is finished).
172	Action not executable while accessing SD card.	Cannot be executed while the SD memory card is being accessed.
173	Action not executable while data save is in progress.	Cannot be executed while data is being saved.
174	Action not executable while data replay is in progress.	Cannot be executed while data is replayed.
175	Ejecting SD card is not possible.	The SD memory card cannot be ejected currently. Try again later.
176	File already exists.	Unable to save because a file with the same name already exists. Change the file name.
177	File does not exist.	The specified file does not exist. Check the file name.
178	There is no SD card.	Insert the SD memory card properly.
179	Please acknowledge all active alarms.	Perform alarm acknowledge operation (alarm ACK).

Operation Errors

Code	Message	Explanation/Countermeasures
232	There is no available data.	There is no data for periodic printout or data for calculating TLOG when the timer expired.
233	SD card access error.	Unable to access the SD memory card. Check that the SD memory card is inserted properly, that there is enough free space, and that the card is not locked.
234	The file is damaged.	The file is corrupt.
235	The file is not supported.	Data replay is not possible because the model, option, or version is different.

Communication Errors

Code	Message	Explanation/Countermeasures
300	Command is too long.	–
301	Too many number of commands delimited with ';'. .	Keep the number of commands separated by sub delimiters under 10.
302	This command has not been defined.	–
303	Data request command can not be enumerated with sub-delimiter.	–
350	Command is not permitted to the current user level.	–

Code	Message	Explanation/Countermeasures
351	This command cannot be specified in the current mode.	–
352	The option is not installed.	–
353	This command cannot be specified in the current setting.	–
354	This command is not available during calculation.	–
390	Command error.	–
391	Delimiter error.	–
392	Parameter error.	–
393	No permission.	–
394	No such connection.	–
395	Use "quit" to close this connection.	Attempted to disconnect its own connection.
396	Failed to disconnect.	–
397	No TCP control block.	The control block of the specified connection cannot be found.
400	Input username.	–
401	Input password.	–
402	Select username from 'admin' or 'user'.	If the recorder is configured not to use the user name and password, use user names 'admin' or 'user'.
403	Login incorrect, try again!	–
404	No more login at the specified level is acceptable.	–
420	Connection has been lost.	–
421	The number of simultaneous connection has been exceeded.	–
422	Communication has timed-out.	–

Warning Messages

Code	Message	Explanation/Countermeasures
600	Initialized.	Settings and measured data have been initialized. If this message always appears when you turn the power off and then back on, contact your nearest YOKOGAWA dealer.
612	Some items not set.	Some of the settings could not be loaded because the model, the number of channels, options, the setup items in basic setting mode, or the like was different. If you change a setup item in Basic Setting mode from the Configuration Software, load the settings of Basic Setting mode. See "Loading the Settings of Basic Setting Mode and Setting Mode" in "Loading Setup Data" of the μ R10000/ μ R20000 SD Memory Card (/EM1 Option) User's Manual (IM 04P01B01-03E).
613	Less than 10% free space on the SD card.	The amount of free space on the SD memory card is low. Stop recording to the SD memory card and replace the SD memory card.
614	Less than 25 MB free space on the SD card.	The amount of free space on the SD memory card is low. Replace the SD memory card.

System Errors

Code	Message	Explanation/Countermeasures
902	RAM failure.	Contact your nearest YOKOGAWA dealer.
910	A/D error.	Contact your nearest YOKOGAWA dealer.
921	A/D calibration value error.	Contact your nearest YOKOGAWA dealer.
922	A/D calibration is in the wrong order.	Contact your nearest YOKOGAWA dealer.
930	Memory acquisition failure.	Contact your nearest YOKOGAWA dealer.
940	The ethernet module is down.	Contact your nearest YOKOGAWA dealer.
950	A/D number error.	Contact your nearest YOKOGAWA dealer.
951	EEPROM write error.	Contact your nearest YOKOGAWA dealer.
960	Ribbon error	Contact your nearest YOKOGAWA dealer.
961	Printer error	Contact your nearest YOKOGAWA dealer.
962	Plotter error	Contact your nearest YOKOGAWA dealer.
963	Pen 1 error	Contact your nearest YOKOGAWA dealer.
964	Pen 2 error	Contact your nearest YOKOGAWA dealer.
965	Pen 3 error	Contact your nearest YOKOGAWA dealer.
966	Pen 4 error	Contact your nearest YOKOGAWA dealer.
B5	(No messages)	Contact your nearest YOKOGAWA dealer.
B6	(No messages)	Contact your nearest YOKOGAWA dealer.

10.2 Troubleshooting Flow Charts

Follow the flow charts to correct the problem.

Nothing works (pen and chart paper do not move).

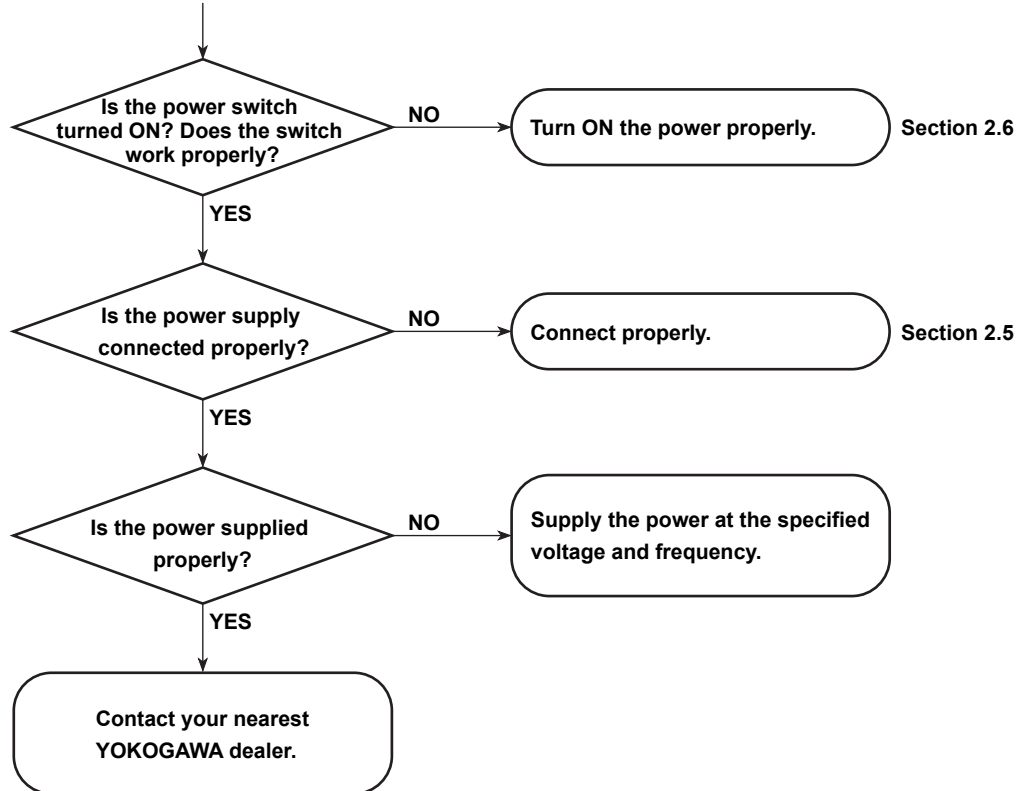

- The reading error is large.
- The indication is unstable.
- The pen is off the scale on either the 0% or 100% side.

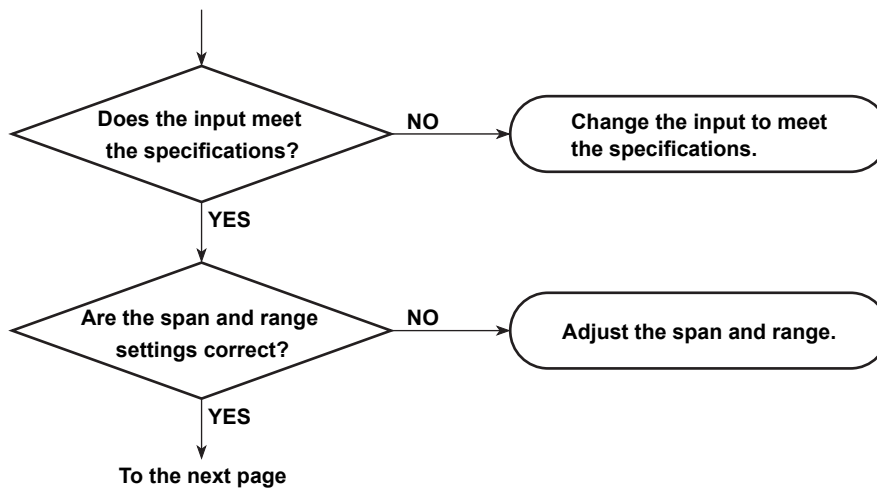

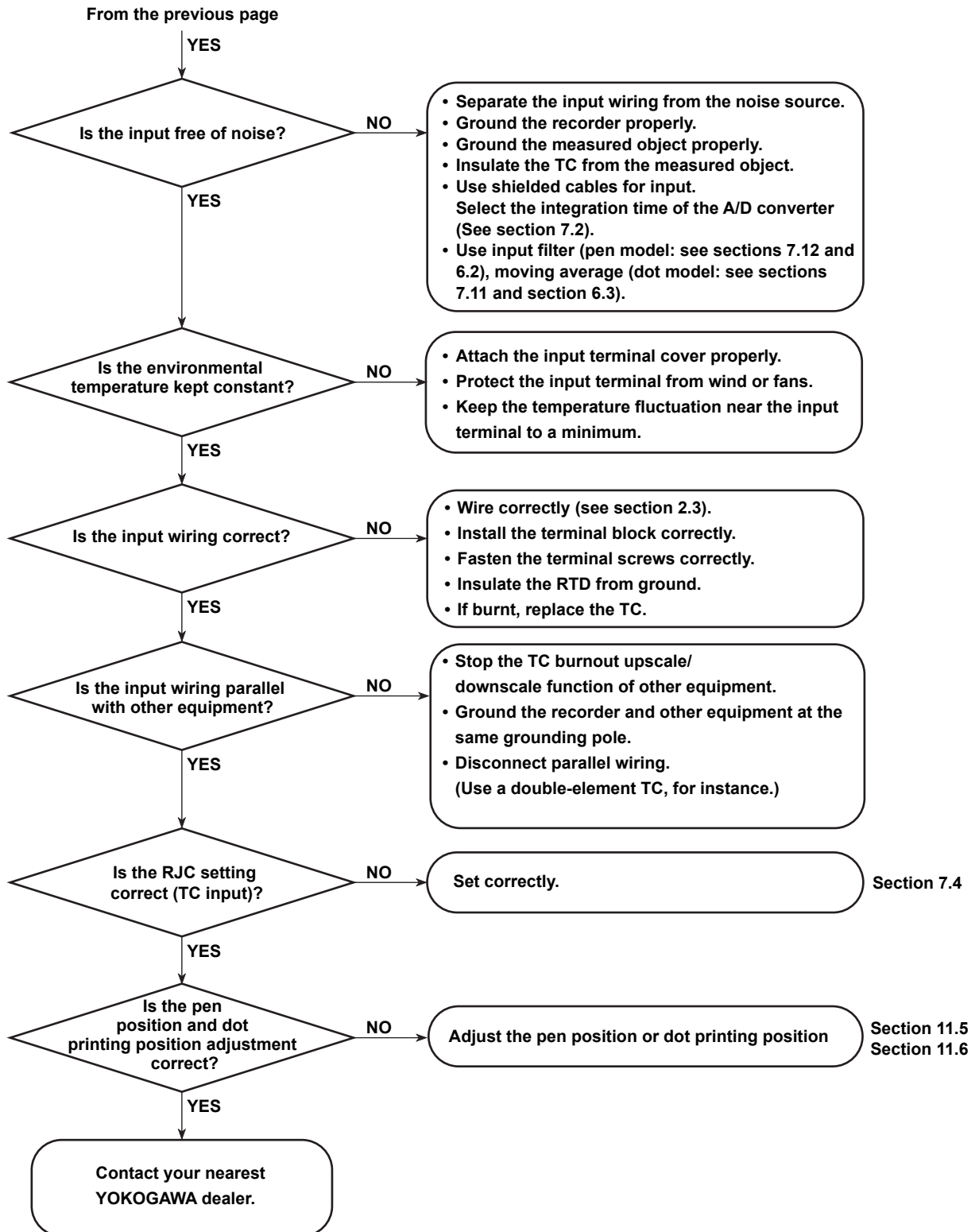

10.2 Troubleshooting Flow Charts

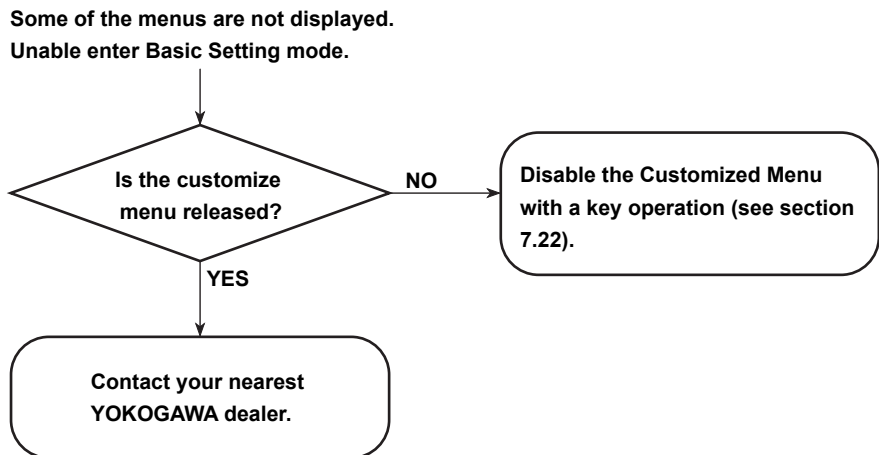
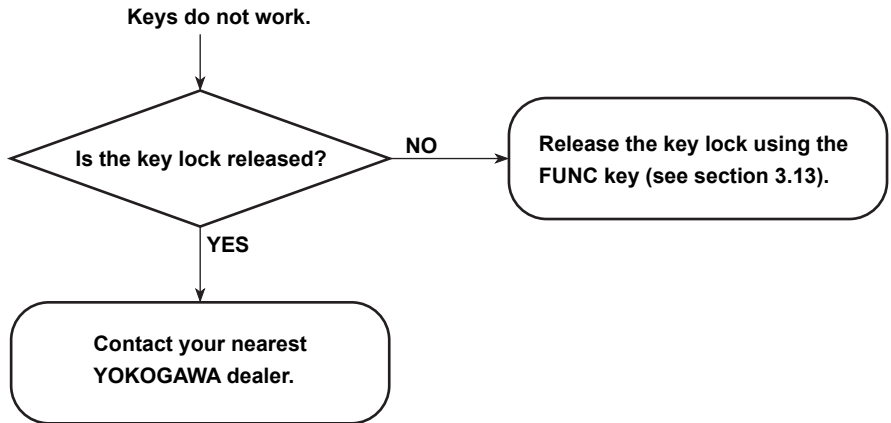
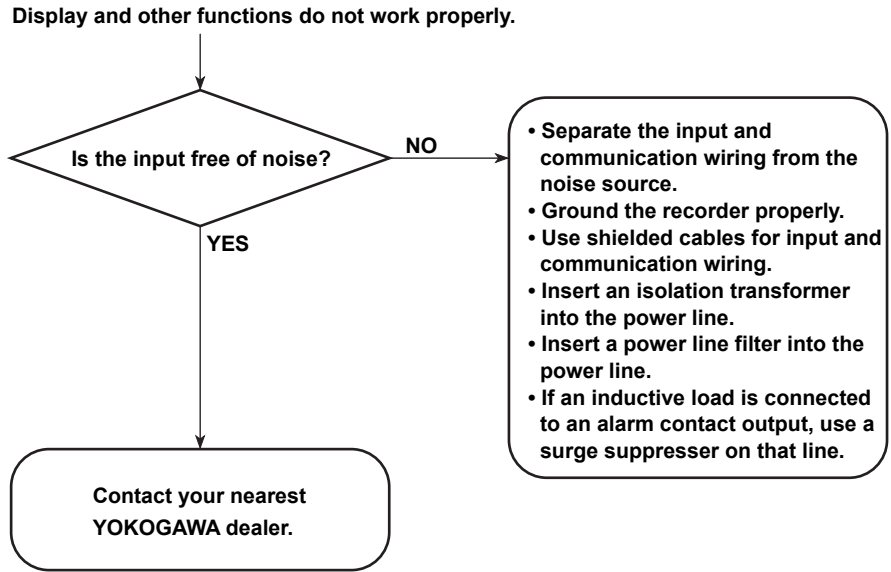

11.1 Periodic Inspection

Check the operation periodically to keep the recorder in good working order. Perform the following checks and replace worn parts as needed.

- Is the indication and recording functioning properly? If not, see chapter 10.
- Are recorded lines or printed characters clear (not blurred)?
For the replacement procedure of felt pens and plotter pens, see section 3.3 (pen model).

For the replacement procedure of the ribbon cassette, see section 3.4 (dot model).

- Is the chart paper feeding properly (no paper jams)? If not, see chapter 10.
- Is there enough chart paper remaining?

Remaining chart length is printed on the left margin of the chart at intervals of 20 cm. For the chart paper replacement procedure, see section 3.2.

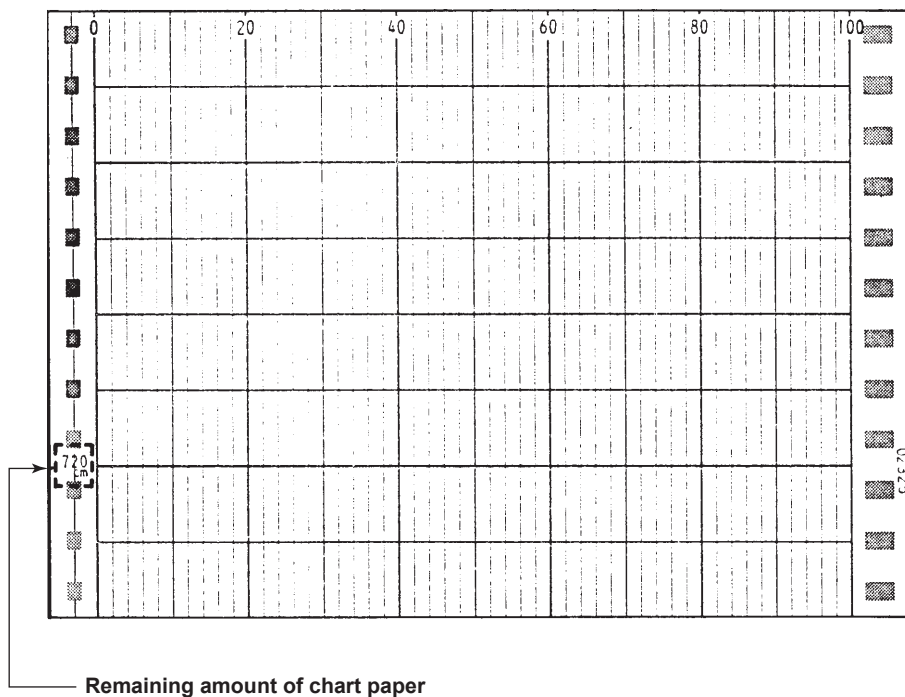

11.2 Cleaning the Recorder

CAUTION

- When cleaning, be sure not to scratch the flexible printed circuit board of the plotter carriage.
 - Do not apply lubricating oil to the shaft.
-

Pen Model

To maintain smooth operation, it is recommended that the plotter carriage shaft be cleaned once a year.

Cleaning Procedure

Wipe the dust off the plotter carriage shaft using a soft lint-free cloth or paper. If the dirt does not come off easily, apply ethyl alcohol to the cloth or paper.

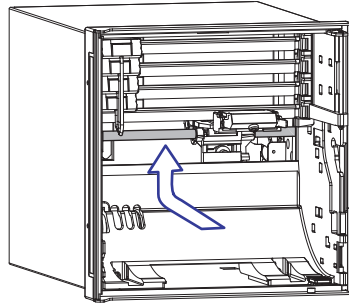

Dot Model

To maintain smooth operation, wipe the dust off the two shafts of the printer carriage using a soft lint-free cloth or paper. It is recommended that these shafts be cleaned once a year.

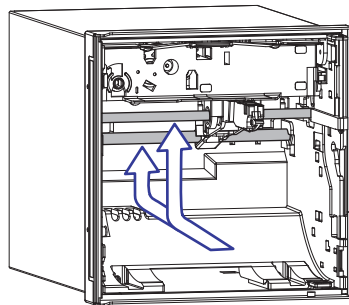

11.3 Replacing the Internal Light LED

If the brightness of the internal light degrades with time, replace the LED.
For the replacement parts, see section 11.7.

CAUTION

- The LED is connected to the internal circuitry through the flexible printed circuit board. Do not pull the LED with force.
- Be sure not to break the flexible printed circuit board.

Replacement Procedure

1. Open the door and turn OFF the power switch.
2. Open the display and key panel section.
3. Pull out the internal light LED assembly that is attached to the end of the display and key panel section.

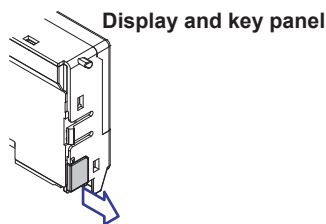

4. Remove the LED assembly from the connector of the flexible printed circuit board.

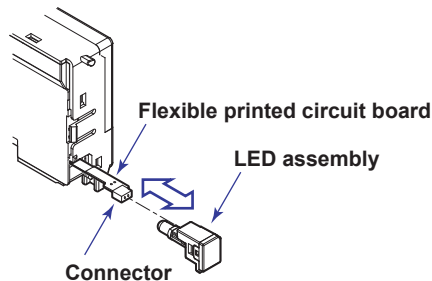

5. Connect the new LED assembly.
6. Push the LED assembly back into the display and key panel section. Be sure not to bend or scratch the flexible printed circuit board.

Stored condition of the flexible printed circuit board

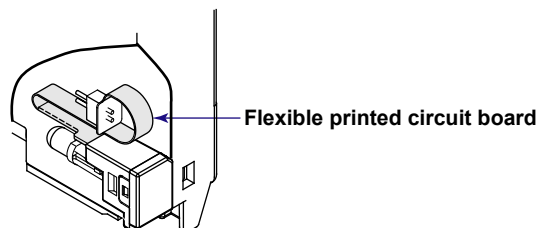

7. Turn the power switch ON and check that the internal light comes on a few seconds later.

11.4 Calibrating the Recorder

Calibrate the measured value against the input.

It is recommended that the recorder be calibrated once a year to assure its measurement accuracy.

For details regarding calibration, contact your nearest YOKOGAWA dealer.

Required Instruments

A calibration instrument with appropriate resolution is required for calibrating the recorder.

Recommended Instrument

- DC voltage standard: Model 9100 by FLUKE or equivalent

Main Specifications

Output accuracy: $\pm(0.005\% + 1 \mu\text{V})$

- Decade resistance box: Yokogawa Test & Measurement Model 2793-01 or equivalent

Main Specifications

Accuracy of output range 0.1 to 500 Ω : $\pm(0.01\% + 2 \text{ m}\Omega)$

Resolution: 0.001 Ω

- 0°C standard temperature device: ZC-114/ZA-10 by Coper Electronics or equivalent

Main Specifications

Standard temperature stability accuracy: $\pm 0.05^\circ\text{C}$

For information on purchasing the calibration instruments, contact your nearest YOKOGAWA dealer.

Calibration Procedure

1. Wire the recorder and the calibration instrument as shown in the following figure, and adequately warm up the instruments (the warm-up time of the recorder is at least 30 minutes).
2. Check that the operating environment such as ambient temperature and humidity is within the normal operating conditions (see section 12.6).
3. Apply appropriate input signals corresponding to 0%, 50%, and 100% of the input range and calculate the errors from the readings.
If the error is outside the accuracy specifications, contact your nearest YOKOGAWA dealer.

Note

For thermocouple inputs, you must measure the temperature of the input terminal and apply a voltage taking into account the reference junction temperature.

DC Voltage Measurement

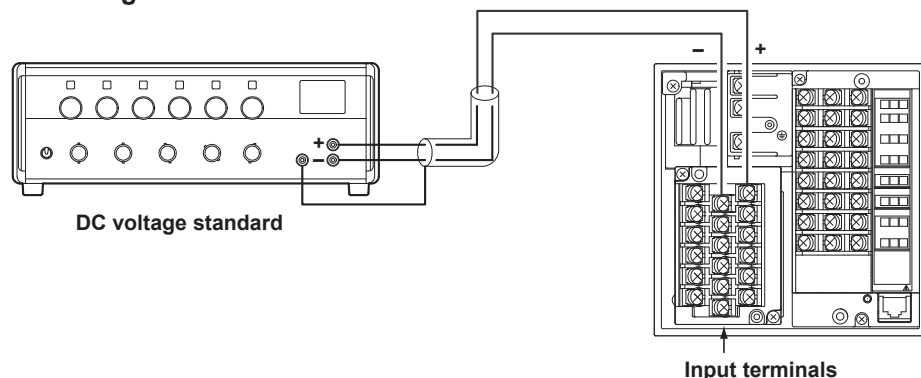

Temperature Measurement When Using an RTD

The resistance of three lead wires must be equal.

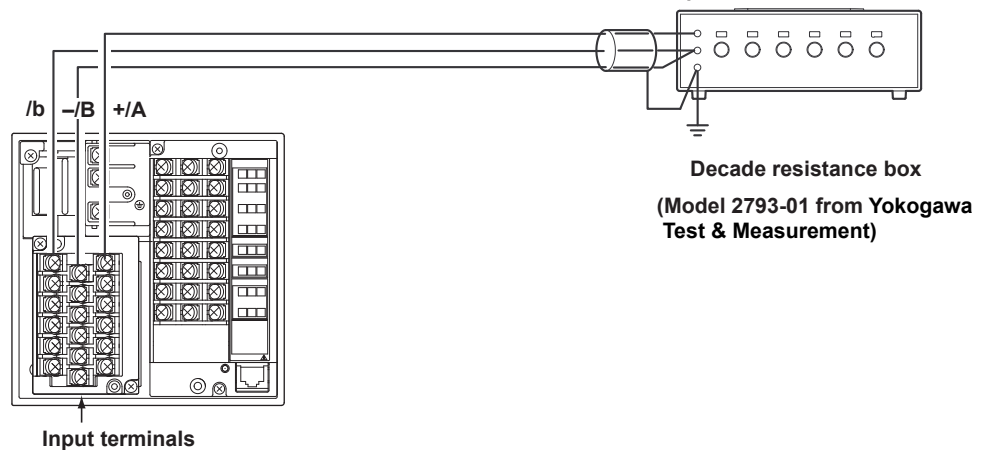

Temperature Measurement When Using a Thermocouple

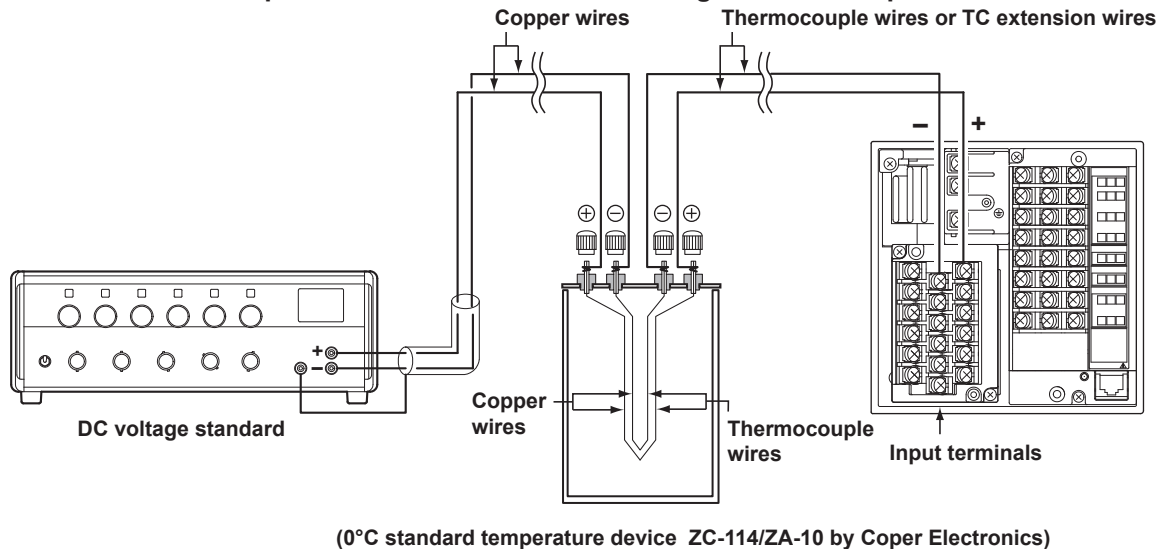

RJC of TC input

As the measurement terminal of the recorder is generally at room temperature, the actual output of the thermocouple is different from the values given on the thermoelectromotive force table based on 0°C. The recorder performs compensation by measuring the temperature at the input terminal and adding the corresponding thermoelectromotive force to the actual output of the thermocouple. Therefore, when the measurement terminal is shorted (equivalent to the case when the detector tip is 0°C), the measured value indicates the temperature of the input terminal.

When calibrating the recorder, this compensation voltage (thermoelectromotive force of 0°C reference corresponding to the input terminal temperature) must be subtracted from the output of the DC voltage standard before application. As shown in the figure, by using the 0°C standard temperature device to compensate the reference junction at 0°C, you can input the thermoelectromotive force of 0°C reference from the DC voltage standard and perform the calibration.

11.5 Adjusting the Pen Position (Pen Model)

This section explains the details of adjusting the pen position on the chart paper. It is recommended that the pen be adjusted once a year to assure its recording accuracy.

Note

Pen position is adjusted under standard operating conditions when the recorder is shipped from the factory. Because the chart paper may expand or contract depending on the environment in which the recorder is used, it is recommended that the position be readjusted before use.

Procedure

1. Warm up the recorder for at least 30 minutes.
2. Check that the operating environment such as ambient temperature and humidity is within the normal operating conditions (see section 12.6).
3. Hold down the **MENU** key for 3 seconds to enter Setting mode.
4. Hold down the **▽△** and **◀▶** keys simultaneously for 3 seconds to enter Basic Setting mode.
5. Press the **▽△** key or **SHIFT+▽△** key to select **P_Adj** and then press the **↵** key.
6. Press the **▽△** key to select **Zero** (left edge of the chart paper) or **Full** (right edge of the chart paper) and then press the **↵** key. Adjust Zero first and then Full.
7. Select the **Pen No.**
8. Adjust the pen position.
Increase or decrease the setting to align the pen position with the scale line on the chart paper. Then, press the **↵** key. To change the setting, press the **◀▶** key to move the cursor and **▽△** key to change the value.
The pen moves after the **↵** key is pressed.
A value change of 1 corresponds to 0.033 mm change in the pen position. Decreasing the value moves the pen to the left and increasing the value moves the pen to the right.
9. Press the **↵** key to set adjust other pens.
Press the **ESC** key to finish the adjustment. The screen returns to the **Basic=P_Adj** screen.

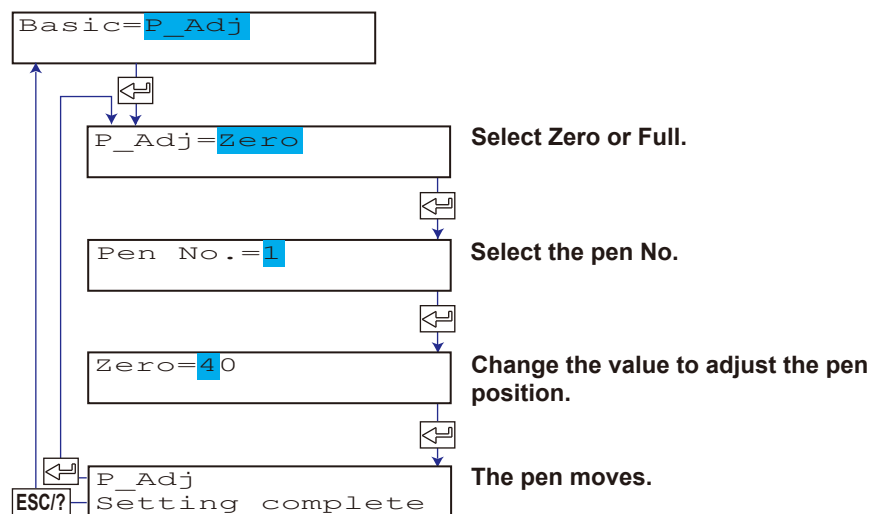

Applying the Changes and Returning to Operation Mode

Press the $\nabla\Delta$ key or **SHIFT** + $\nabla\Delta$ key to select **End** and then press the \leftarrow key. Press the $\nabla\Delta$ key to select **Store** and then press the \leftarrow key. The changes are applied, and the screen returns to Operation mode. If you select **Abort** and press the \leftarrow key, the changes are discarded, and the screen returns to Operation mode. Press the **ESC** key to return to the **Basic=** screen.

Note

When the Customized Menu is enabled, the operation is different.

- **When “P_Adj” in the Customized Menu is On**
 1. Perform steps 1-4 of “Adjusting the Pen Position.”
 2. When the instrument enters Basic Setting mode, “Menu kind” appears. Select “Free” then press a \leftarrow key.
 3. Perform the steps starting with step 5 of “Adjusting the Pen Position.”
 - **When “P_Adj” in the Customized Menu is Off**

See “Disabling the Customized Menu” or “Changing the Settings without Disabling the Basic Setting Mode Lock.”
-

<Related Topics> Enabling/Disabling the customized menu: Section 7.22
Changing the settings without releasing the basic setting mode lock:
Section 7.22

11.6 Adjusting the Dot Printing Position (Dot Model)

This section explains the details of adjusting the dot printing position on the chart paper. It is recommended that the position be adjusted once a year to assure its recording accuracy.

Note

Dot printing position is adjusted under standard operating conditions when the recorder is shipped from the factory. Because the chart paper may expand or contract depending on the environment in which the recorder is used, it is recommended that the position be readjusted before use.

Procedure

1. Warm up the recorder for at least 30 minutes.
2. Check that the operating environment such as ambient temperature and humidity is within the normal operating conditions (see section 12.6).
3. Hold down the **MENU** key for 3 seconds to enter Setting mode.
4. Hold down the $\nabla\Delta$ and $\triangleleft\triangleright$ keys simultaneously for 3 seconds to enter Basic Setting mode.
5. Press the $\nabla\Delta$ key or **SHIFT** + $\nabla\Delta$ key to select **P_Adj** and then press the \triangleleft key.
6. Press the $\triangleleft\triangleright$ key to select **Hysteresis, Zero** (left edge of the chart paper), or **Full** (right edge of the chart paper) and then press the \triangleleft key. Adjust Hysteresis first followed by Zero and then Full.

Adjusting the Hysteresis

A line is drawn on the chart paper. If the line appears as shown in Figure a, increase the displayed setting. Then press the \triangleleft key. If the line appears as shown in Figure b, decrease the displayed setting. Then, press the \triangleleft key.

To change the setting, press the $\triangleleft\triangleright$ key to move the cursor and $\nabla\Delta$ key to change the value.

Repeat this procedure until the line becomes straight.

A value change of 1 corresponds to 0.1 mm change in the dot printing position.

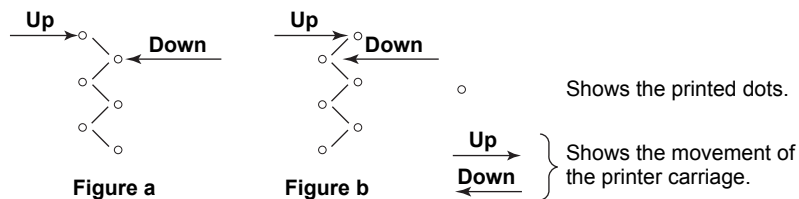

Adjusting Zero and Full

A line is drawn to the left edge for Zero and right edge for Full.

Increase or decrease the displayed setting so that the drawn line is aligned with the scale line on the chart paper. Then, press the \triangleleft key. The procedure of changing the setting is the same as with the adjustment of hysteresis.

The line moves after the \triangleleft key is pressed.

A value change of 1 corresponds to 0.1mm change in the dot printing position.

Decreasing the value moves the line to the left and increasing the value moves the line to the right.

7. Press the **ESC** key to finish the adjustment. The screen returns to the **Basic=P_Adj** screen.

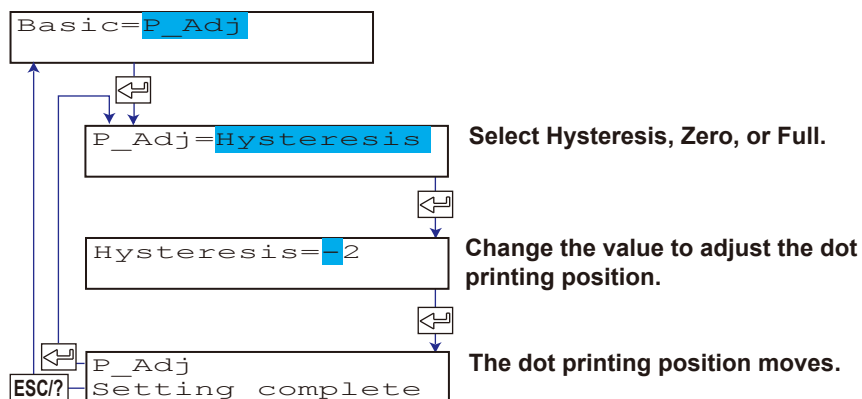

Applying the Changes and Returning to Operation Mode

Press the $\nabla\Delta$ key or **SHIFT** + $\nabla\Delta$ key to select **End** and then press the \leftarrow key. Press the $\nabla\Delta$ key to select **Store** and then press the \leftarrow key. The changes are applied, and the screen returns to Operation mode. If you select **Abort** and press the \leftarrow key, the changes are discarded, and the screen returns to Operation mode. Press the **ESC** key to return to the **Basic=** screen.

Note

When the Customized Menu is enabled, the operation is different.

- **When "P_Adj" in the Customized Menu is On**
 1. Perform steps 1-4 of "Adjusting the Dot Printing Position."
 2. When the instrument enters Basic Setting mode, "Menu kind" appears. Select "Free" then press a \leftarrow key.
 3. Perform the steps starting with step 5 of "Adjusting the Dot Printing Position."
- **When "P_Adj" in the Customized Menu is Off**

See "Disabling the Customized Menu" or "Changing the Settings without Disabling the Basic Setting Mode Lock."

<Related Topics> Enabling/Disabling the customized menu: Section 7.22
 Changing the settings without releasing the basic setting mode lock:
 Section 7.22

11.7 Recommended Replacement Periods for Worn Parts

To preserve the reliability of the recorder and to use the recorder in good condition for an extended time, it is recommended that periodic replacements be made on parts. The replacement parts may change to accommodate preventive maintenance over extended time. Be sure to check with your nearest YOKOGAWA dealer.

The table below shows the recommended replacement period for expendable parts.

The replacement period shown here applies when the recorder is used under standard operating conditions. For the actual replacement period, consider the actual conditions of use.

Replacement of parts other than the chart paper, pen, ribbon cassette, and internal light LED will be carried out by a YOKOGAWA engineer or an engineer certified by YOKOGAWA. Contact your nearest YOKOGAWA dealer when such replacement is necessary.

Note

The replacement period of the display and the internal light LED is the half life of the brightness. The deterioration of brightness varies depending on the condition of use, and its determination is subjective. Consider these facts for determining the actual replacement period.

Pen Model

Item	Replacement Period	Part Name	Part No.	Note	Quantity Used
Z-fold chart paper	33 days	CHART	B9565AW	When used at 20 mm/h	1
Felt pen	2 km	PEN ASSY	B9902AM B9902AN B9902AP B9902AQ	Red Green Blue Violet } At a pen speed of 10 cm/s	1 each
Plotter pen	60,000 characters**	PEN ASSY	B9902AR	When printing continuously	1
Display	5 years*	DISPLAY ASSY	B8800CA		1
Chart paper feed motor	5 years	MOTOR ASSY	B8801BP		1
Plotter carriage	5 years	CARRIAGE ASSY	B8801BJ		1
Plotter motor	5 years	MOTOR ASSY	B8801BR	For the X-axis	1
Lever bearing	5 years	BEARING	B9900RP	For the plotter	1
Pen servo	5 years	SERVO ASSY	B8800GG	Shared by all pens (excludes the pen arm ASSY)	1 to 4
Internal light LED	2 years*	LED ASSY	B8800CR		1

* The half life of the brightness at the factory default brightness setting.

** Smearing may occur around the ridge-folding part of the chart paper.

Dot Model

Item	Replacement Period	Part Name	Part No.	Note	Quantity Used
Z-fold chart paper	33 days	CHART	B9565AW	When used at 20 mm/h	1
Ribbon cassette	3 months	RIBBON CASSETTE	B9901AX		1
Display	5 years*	DISPLAY ASSY	B8800CA		1
Chart paper feed motor	5 years	MOTOR ASSY	B8801BP		1
Lever	3 years	LEVER ASSY	B9901EK	For the carriage	1
Pulley	3 years	PULLY	B9963CJ	For the carriage	2
Carriage motor	5 years	MOTOR ASSY	B9963CF		1
Carriage	5 years	CARRIAGE ASSY	B9963CL		1
Ribbon shift motor	5 years	MOTOR ASSY	B8801BR		1
Ribbon shift gear	5 years	GEAR	B8801BX B8801BW		1 each
Ribbon feed motor	5 years	MOTOR ASSY	B8801BP		1
Ribbon feed gear	5 years	RIBBON HOLDER ASSY	B8801AG	Included RIBBON FEED MOTOR, RIBBON HOLDER	1
Internal light LED	2 years*	LED ASSY	B8800CR		1

* The half life of the brightness at the factory default brightness setting.

12.1 Input Specifications

Number of Inputs and Scan Interval on the Pen Model

Item	Specifications
Number of inputs	1, 2, 3, or 4
Scan interval	125 ms

Number of Inputs and Scan Interval on the Dot Model

Item	Specifications
Number of inputs	6
Scan interval	1 s (when the integration time of the A/D converter is 20 ms or 16.7 ms) 2.5 s (when the integration time of the A/D converter is 100 ms)

Input Type

Item	Specifications																																																							
Input type	DC voltage, 1-5V, TC, RTD, DI (ON/OFF input), DC current (by adding an external shunt resistor)																																																							
Input Type and Measurable Range																																																								
	<table border="1"> <thead> <tr> <th>Input</th> <th>Range Type</th> <th>Measurable Range</th> </tr> </thead> <tbody> <tr> <td rowspan="8">Volt</td> <td>20 mV</td> <td>-20.00 to 20.00 mV</td> </tr> <tr> <td>60 mV</td> <td>-60.00 to 60.00 mV</td> </tr> <tr> <td>200 mV</td> <td>-200.0 to 200.0 mV</td> </tr> <tr> <td>2 V</td> <td>-2.000 to 2.000 V</td> </tr> <tr> <td>6 V</td> <td>-6.000 to 6.000 V</td> </tr> <tr> <td>20 V</td> <td>-20.00 to 20.00 V</td> </tr> <tr> <td>50 V</td> <td>-50.00 to 50.00 V</td> </tr> <tr> <td>1-5V</td> <td>(0.800 to 1.200 V range) to (4.800 to 5.200 V range)</td> </tr> <tr> <td rowspan="12">TC</td> <td>R¹</td> <td>0.0 to 1760.0°C 32 to 3200°F</td> </tr> <tr> <td>S¹</td> <td>0.0 to 1760.0°C 32 to 3200°F</td> </tr> <tr> <td>B¹</td> <td>0.0 to 1820.0°C 32 to 3308°F</td> </tr> <tr> <td>K¹</td> <td>-200.0 to 1370.0°C -328 to 2498°F</td> </tr> <tr> <td>E¹</td> <td>-200.0 to 800.0°C -328.0 to 1472.0°F</td> </tr> <tr> <td>J¹</td> <td>-200.0 to 1100.0°C -328.0 to 2012.0°F</td> </tr> <tr> <td>T¹</td> <td>-200.0 to 400.0°C -328.0 to 752.0°F</td> </tr> <tr> <td>N¹</td> <td>0.0 to 1300.0°C 32 to 2372°F</td> </tr> <tr> <td>W²</td> <td>0.0 to 2315.0°C 32 to 4199°F</td> </tr> <tr> <td>L³</td> <td>-200.0 to 900.0°C -328.0 to 1652.0°F</td> </tr> <tr> <td>U³</td> <td>-200.0 to 400.0°C -328.0 to 752.0°F</td> </tr> <tr> <td>WRe⁴</td> <td>0.0 to 2400.0°C 32 to 4352°F</td> </tr> <tr> <td rowspan="2">RTD</td> <td>PT (Pt100)⁵</td> <td>-200.0 to 600.0°C -328.0 to 1112.0°F</td> </tr> <tr> <td>JPT (JPt100)⁵</td> <td>-200.0 to 550.0°C -328.0 to 1022.0°F</td> </tr> <tr> <td rowspan="2">DI</td> <td>Level</td> <td>0: Less than 2.4 V, 1: Greater than or equal to 2.4 V Within ±6 V</td> </tr> <tr> <td>Contact⁶</td> <td>0: Open, 1: Closed</td> </tr> </tbody> </table>	Input	Range Type	Measurable Range	Volt	20 mV	-20.00 to 20.00 mV	60 mV	-60.00 to 60.00 mV	200 mV	-200.0 to 200.0 mV	2 V	-2.000 to 2.000 V	6 V	-6.000 to 6.000 V	20 V	-20.00 to 20.00 V	50 V	-50.00 to 50.00 V	1-5V	(0.800 to 1.200 V range) to (4.800 to 5.200 V range)	TC	R ¹	0.0 to 1760.0°C 32 to 3200°F	S ¹	0.0 to 1760.0°C 32 to 3200°F	B ¹	0.0 to 1820.0°C 32 to 3308°F	K ¹	-200.0 to 1370.0°C -328 to 2498°F	E ¹	-200.0 to 800.0°C -328.0 to 1472.0°F	J ¹	-200.0 to 1100.0°C -328.0 to 2012.0°F	T ¹	-200.0 to 400.0°C -328.0 to 752.0°F	N ¹	0.0 to 1300.0°C 32 to 2372°F	W ²	0.0 to 2315.0°C 32 to 4199°F	L ³	-200.0 to 900.0°C -328.0 to 1652.0°F	U ³	-200.0 to 400.0°C -328.0 to 752.0°F	WRe ⁴	0.0 to 2400.0°C 32 to 4352°F	RTD	PT (Pt100) ⁵	-200.0 to 600.0°C -328.0 to 1112.0°F	JPT (JPt100) ⁵	-200.0 to 550.0°C -328.0 to 1022.0°F	DI	Level	0: Less than 2.4 V, 1: Greater than or equal to 2.4 V Within ±6 V	Contact ⁶	0: Open, 1: Closed
Input	Range Type	Measurable Range																																																						
Volt	20 mV	-20.00 to 20.00 mV																																																						
	60 mV	-60.00 to 60.00 mV																																																						
	200 mV	-200.0 to 200.0 mV																																																						
	2 V	-2.000 to 2.000 V																																																						
	6 V	-6.000 to 6.000 V																																																						
	20 V	-20.00 to 20.00 V																																																						
	50 V	-50.00 to 50.00 V																																																						
	1-5V	(0.800 to 1.200 V range) to (4.800 to 5.200 V range)																																																						
TC	R ¹	0.0 to 1760.0°C 32 to 3200°F																																																						
	S ¹	0.0 to 1760.0°C 32 to 3200°F																																																						
	B ¹	0.0 to 1820.0°C 32 to 3308°F																																																						
	K ¹	-200.0 to 1370.0°C -328 to 2498°F																																																						
	E ¹	-200.0 to 800.0°C -328.0 to 1472.0°F																																																						
	J ¹	-200.0 to 1100.0°C -328.0 to 2012.0°F																																																						
	T ¹	-200.0 to 400.0°C -328.0 to 752.0°F																																																						
	N ¹	0.0 to 1300.0°C 32 to 2372°F																																																						
	W ²	0.0 to 2315.0°C 32 to 4199°F																																																						
	L ³	-200.0 to 900.0°C -328.0 to 1652.0°F																																																						
	U ³	-200.0 to 400.0°C -328.0 to 752.0°F																																																						
	WRe ⁴	0.0 to 2400.0°C 32 to 4352°F																																																						
RTD	PT (Pt100) ⁵	-200.0 to 600.0°C -328.0 to 1112.0°F																																																						
	JPT (JPt100) ⁵	-200.0 to 550.0°C -328.0 to 1022.0°F																																																						
DI	Level	0: Less than 2.4 V, 1: Greater than or equal to 2.4 V Within ±6 V																																																						
	Contact ⁶	0: Open, 1: Closed																																																						
1	R, S, B, K, E, J, T, N: IEC 584-1 (1995), DIN IEC 584, JIS C1602-1995																																																							
2	W: W-5% Re/W-26% Re (Hoskins Mfg. Co.), ASTM E988																																																							
3	L: Fe-CuNi, DIN 43710, U: Cu-CuNi, DIN 43710																																																							
4	WRe: W-3%Re/W-25%Re (Hoskins Mfg. Co.)																																																							
5	Pt100: JIS C 1604:2013, IEC 60751:2008, DIN EN 60751:2009 JPt100: JIS C1604-1989, JIS C1606-1989 Measurement current: i = 1 mA (Pt100, JPt100)																																																							
6	Detected current value: approx. 10 μA																																																							

12.1 Input Specifications

Item	Specifications
Input type	Floating unbalanced input. Isolation between channels (except, b terminal is shared for RTD input).
Burnout Detection of TC	Can be set for each channel. Upscale/Downscale switchable.
	Input Type Operating Conditions
	TC input 2 kΩ or less: normal, 10 MΩ or more: burnout, detection current: approx. 10 μA
	1-5V input 0.2 V or less: burnout
RJC of TC input	Set whether to use the recorder RJC function or an external RJC function for each channel. Set the compensation voltage when using an external RJC function. Compensation voltage range: -20000 μV to 20000 μV.
A/D converter	
Resolution	16 bits
Integration time	Pen model: Selectable from 20 ms (50 Hz), 16.7 ms (60 Hz), and Auto (auto switch between 20 ms and 16.7 ms according to the power supply frequency). Dot model: Selectable from 20 ms (50 Hz), 16.7 ms (60 Hz), 100 ms and Auto (auto switch between 20 ms and 16.7 ms according to the power supply frequency).
Filter function (pen model)	Filter ON/OFF switchable for each channel. Time constant selectable from 2, 5, and 10 s.
Moving average function (dot model)	Moving average ON/OFF switchable for each channel. The number of samples of the moving average is selectable between 2 and 16.

Input Computation (Standard Function)

Item	Specifications
Delta computation	Calculates the difference between two channel inputs using the following equation. Delta = (the input value of the channel set to delta computation) – (the input value of the reference channel) where (reference channel number) < (channel number set to delta computation). Computable input type: DC voltage, TC, and RTD. The channel set to delta computation and the reference channel is set to the same range type.
Linear scaling	Scales the input value to a value with a unit suitable for the application. Computable input type: DC voltage, TC, RTD, DI Value after scaling Mantissa: -20000 to 30000 Decimal place: Can be set arbitrarily Unit: Can be set arbitrarily (up to 6 characters) Displayable and printable range -19999 to 31500
Computation on the 1-5V input	
Linear scaling	Linearly scales the 1-5V signal. Value after scaling: Same as linear scaling. Displayable and printable range: Same as linear scaling.
Low-cut function	Sets values below 0% of the recording span to the leftmost value of the scale. The leftmost value of scale must be less than the rightmost value of scale.
Square root computation	Takes the square root of the input value and linearly scales the result. Computable input type: DC voltage
Linear scaling	Value after scaling: Same as linear scaling. Displayable and printable range: Same as linear scaling.
Low-cut function	Sets values below the low-cut point to the leftmost value of scale. The leftmost value of scale must be less than the rightmost value of scale. Low-cut point range: 0.0 to 5.0% of the recording span (0.1% steps)
Bias	Adds a bias to the measuring input value. Bias value range: ±10% of the span of the measurable range at the specified range type. ±10% of the scaling span if linear scaling is used.

12.2 Alarm Function Specifications

Item	Specifications
Number of alarms	Up to four alarms (level) for each measurement channels.
Alarm types	<p>High limit (H), low limit (L), difference high limit (h), difference low limit (l), high limit on rate-of-change (R), low limit on rate-of-change (r), delay high limit (T), delay low limit (t). The symbol indicating the alarm is given in parentheses.</p> <p>Rate-of-change calculation interval of rate-of-change alarms (can be set individually for the high limit on rate-of-change and low limit on rate-of-change alarms)</p> <p>Rate-of-change calculation interval = Scan interval × the number of sampled data where the number of sample data is a value between 1 and 15</p> <p>Alarm delay time of delay high and low limit alarms (can be set for each channel, common within a channel)</p> <p>1 to 3600 s (1 hour)</p> <p>However, if the alarm delay time setting is not an integer multiple of the scan interval, the alarm delay time is set to a value that is the first integer multiple of the scan interval exceeding the delay time setting.</p>
Hysteresis	<p>Set a width to the value for detecting alarm occurrence/release (common to all channels and all levels)</p> <p>Applied to high limit alarm and low limit alarm.</p> <p>Hysteresis range: Approx. 0.0% to 1.0% of the recording span (0.1% steps)</p>
Display	<p>Indicates the alarm occurrence status on the display.</p> <p>Indication for each channel: Displays the alarm type (display precedence: H, L, T, t, h, l, R, and r).</p> <p>Alarm summary display: Displayed using an icon.</p> <p>Displays the alarm point mark and status on the bar graph.</p> <p>Non-hold/hold operation of alarm indication</p> <p>Turn ON/OFF the indication along with the alarm occurrence/release (non-hold) or hold the indication until the alarm ACK operation.</p>
Alarm relay contact output (optional specifications)	See section 12.5

12.3 Recording Function Specifications

Trend Recording (Pen Model)

Item	Specifications
Recording pen	Disposable felt pen
Step response time	Approx. 1 s (using the IEC61143 measurement method)
Number of pens	Up to 4
Recording color	Pen 1: Red, pen 2: Green, pen 3: Blue, pen 4: Violet
Trend recording	Updates the data at the scan interval. Continuous recording.
Pen offset compensation	Records by compensating for the offset of each pen along the time axis.
Chart speed	5 to 12000 mm/h (82 steps).
Zone recording	Recording zone can be specified for each channel. Recording width: 5 mm or more (1 mm steps)
Partial expanded recording	Records by expanding the right or left side of the boundary position (the other section is reduced). Boundary position: 1 to 99% Boundary value: Within the recording span range

Trend Recording (Dot Model)

Item	Specifications
Recording method	Trend recording by a 6-color wire dot printer
Recording color	Channel 1: Purple, channel 2: Red, channel 3: Green, channel 4: Blue, channel 5: Brown, channel 6: Black
Trend recording interval	Records at the following interval through a raster scan system. Auto: Synchronizes to the chart speed and automatically sets to the interval so that the dots do not overlap many times. Fix: 10 s/6 channels (see section 12.5 for the recording interval on models with the computation function (/M1 option))
Chart speed	1 to 1500 mm/h (1 mm steps)
Recording ON/OFF	Recording can be turned ON/OFF for each channel.
Zone recording	Same as the pen model.
Partial expanded recording	Same as the pen model.

Chart Paper

Item	Specifications
Printing width	100 mm
Type/Length	Z-fold type. Approx. 16 m.
Chart paper feeding accuracy	Within $\pm 0.1\%$ After feeding 1000 mm and with respect to the print scale on the chart paper.

Printouts (Pen Model)

Item	Specifications
Recording pen (color)	Plotter pen (purple)
Alarm printout	Prints alarm occurrence/release.
Printout contents	Occurrence (△)/release (▽) marks, channel number or tag, alarm type, alarm level, time, printout buffer overflow mark.
Time printout format	Selectable from hour:minute, hour:minute:second, month:day:hour:minute, month:day:hour:minute:second, and year:month:day:hour:minute:second.
Alarm printout buffer	Stores 8 occurrences of alarm information waiting to be printed.
Periodic printout	Prints at specified time intervals from the reference time.
Interval (see appendix 2)	Reference time: 00 hour 00 minute to 23 hour 00 minute (1 hour steps, minute fixed) Auto: Automatically determined from the chart speed. Manual: Select 10 min, 12 min, 15 min, 20 min, 30 min, 1 hour, 2 hours, 3 hours, 4 hours, 6 hours, 8 hours, 12 hours, or 24 hours.
Mode	Selectable from disable periodic printout, print instantaneous values, and print report data (report mode). Report data: Selectable from the average, minimum, maximum, minimum/maximum/average, sum value, and instantaneous value.
Printout contents	For instantaneous values: Date/Time, offset compensation ON/OFF, channel information (measured value, alarm status, unit, delta computation ON/OFF, scale, channel number or tag, recording color), chart speed (with time ticks) For report data: Report start/end date/time, offset compensation ON/OFF, events, channel information (value, unit, range change occurrence, scale, recording color), chart speed (with time ticks)
Message printout	Prints preset message strings.
Number of messages	5
Printout contents	Time, message (up to 16 characters), printout buffer overflow mark.
Time printout format	Selectable from hour:minute, hour:minute:second, month:day:hour:minute, month:day:hour:minute:second, year:month:day:hour:minute:second, and not print.
Message printout buffer	Stores 5 messages waiting to be printed.
Recording start printout	Prints at the start of recording.
Printout contents	Time and chart speed, printout buffer overflow mark.
Time printout format	Selectable from hour:minute, hour:minute:second, month:day:hour:minute, month:day:hour:minute:second, and year:month:day:hour:minute:second.
New chart speed printout	Prints when the chart speed is changed.
Printout contents	Chart speed and time, printout buffer overflow mark.
Time printout format	Selectable from hour:minute, hour:minute:second, month:day:hour:minute, month:day:hour:minute:second, and year:month:day:hour:minute:second.
Manual printout	Prints the measured values of all channels and the computed results when computation mode is on.
Printout contents	Measured values of all channels at that point. Trend recording is temporarily suspended.
Setting printout (List)	Prints the settings of items in Setting mode.
Printout contents	Range setting, alarm setting, etc. Trend recording is temporarily suspended.
Setting printout (Setup)	Prints the settings of items in Basic Setting mode.
Printout contents	Basic alarm specifications, basic recording specifications, etc. Trend recording is temporarily suspended.

Items dependent on the chart speed

Chart speed	Periodic printout	Alarm printout Message printout Record start printout New chart speed printout
5 to 9 mm/h	Not printed	Printed
10 to 1500 mm/h	Printed	Printed
1600 mm/h or higher	Not printed	Not printed

Chart speed	Periodic printout interval
10 to 18 mm/h	8 hours
20 to 36 mm/h	4 hours
40 to 72 mm/h	2 hours
75 to 135 mm/h	1 hour
150 to 180 mm/h	30 minutes
200 to 320 mm/h	20 minutes
360 to 1500 mm/h	10 minutes

Date printout format Select the printout format of the date from Y/M/D, M/D/Y, D/M/Y, D.M.Y, and M.D.Y. The format applies to the date printout of all printout items (version 1.11 and later).

12.3 Recording Function Specifications

Printout (Dot Model)

Item	Specifications
Recording	Dot printing.
Channel printout	Prints the channel number or tag beside the trend recording every approx. 25 mm of chart paper. Channel printout ON/OFF selectable.
Alarm printout	Prints alarm occurrence/release.
Printout contents	Occurrence (△, red)/release (▽, blue) marks, channel number or tag, alarm type, alarm level, time, printout buffer overflow mark.
Time printout format	Selectable from hour:minute, hour:minute:second, month day hour:minute, month day hour:minute:second, and month day year hour:minute:second.
Alarm printout buffer	Stores 12 occurrences of alarm information waiting to be printed.
Periodic printout	Prints at specified time intervals from the reference time.
Interval (see appendix 2)	Same as the pen model.
Measured value	Same as the pen model.
Printout contents	For instantaneous values: Same as the pen model except offset compensation ON/OFF and recording color are not printed. For report data: Same as the pen model except offset compensation ON/OFF and recording color are not printed.
Message printout	Same as the pen model.
Recording start printout	Same as the pen model. With time ticks.
New chart speed printout	Same as the pen model. With time ticks.
Manual printout	Same as the pen model.
Setting printout (List)	Same as the pen model.
Setting printout (Setup)	Same as the pen model.

Items dependent on the chart speed

Chart speed	Channel printout	Periodic printout	Alarm printout Message printout Record start printout New chart speed printout
1 to 9 mm/h	Printed	Not printed	Printed
10 to 100 mm/h	Printed	Printed	Printed
101 to 1500 mm/h	Not printed	Not printed	Not printed

Chart speed	Periodic printout interval
10 to 19 mm/h	8 hours
20 to 39 mm/h	4 hours
40 to 79 mm/h	2 hours
80 to 100 mm/h	1 hour

Date printout format	Same as the pen model.
----------------------	------------------------

Values for Special Measured Values

Same as "Special values" for the digital display on page 12-8.

12.4 Display Function Specifications

Display and Displayed Contents

This section explains the specifications of the display functions of measurement channels and computation channels (/M1 option). Display examples are illustrations used to explain the displayed contents and differ in appearance from the actual displays.

Item	Specifications
Display	VFD (101 × 16, dot matrix) Up to 11 characters using large fonts. 17 characters × 2 lines using normal fonts.
Number of screens	15 (switched using keys)
Displayed information	
Display type	1CH digital display 2CH digital display 4CH digital display 6CH digital display (dot model) 1CH digital + 1CH bargraph display 1CH digital + 4CH bargraph display (pen model) 2CH digital + 2CH bargraph display 4CH bargraph display (pen model) 6CH bargraph display (dot model) Flag display Channel alarm status display Date, time, and chart speed display DI/DO status display (/Ax or /R1 option) 1CH digital display (tag display) 2CH digital display (tag display) 1CH digital + 1CH bargraph display (tag display) 1CH digital + 4CH bargraph display (tag display) (pen model) Status display System display Batch name display (/BT1 option) SD memory card status display (/EM1 option) Lights out Skip Multiple display The following screens can be assigned arbitrarily to the top and bottom sections of the display. 1CH digital display 2CH digital display Date/Time Chart speed display Channel alarm status display 1CH digital display (tag display) Status display Lights out
Display update of measured values / computed values	
When displayed channels are fixed	Dot model: Updated at the scan interval Pen model: Updated every 2 s
When displayed channels are automatically switched	Switches the channel and measured values at 1, 2, 3, 4, or 5 second intervals.
Status display	
RECORD	This indicator turns ON when recording is started and turns OFF when stopped.
ALARM	The indicator turns ON when an alarm occurs and turns OFF when the alarm is released. If the alarm indication is set to hold operation, the indicator blinks when an alarm occurs. When alarm ACK operation is performed, the indicator turns ON or OFF.
MATH	This indicator turns ON when computation on the computation function (/M1 option) is started and turns OFF when stopped.
KEYLOCK	This indicator turns ON when key lock is activated and turns OFF when released.

12.4 Display Function Specifications

Item	Specifications
CHART END	This indicator turns ON when the remaining amount of chart paper falls to approximately 2 cm on models with the FAIL/chart end detection and output function (/F1 option).

Display type specifications

Digital display

Measured value or computed value

- DC voltage input: Displays values between “the min. measurable value – 5% of the span of the measurable range” and “the max. measurable value + 5% of the span of the measurable range” of the range (example: –2.200 to 2.200 V for the 2 V range).
- TC and RTD input: Displays values for input values between “the min. measurable value – 10°C” and “the max. measurable value + 10°C” (example: –10.0°C to 1770.0°C for TC R)
- ON/OFF input (DI): Displays the input value 0 or 1.
- Linear scaling (1-5V, scaling, and square root): Displays value for input values between “the leftmost value of scale – 5% of scaling span” and “the rightmost value of scale + 5% of scaling span” (example: –5.0 to 105.0 when scaled to 0.000 to 100.0). However, the displayable range during scaling is from –19999 to 31500 (excluding the decimal). Values below –19999 and values above 31500 are displayed as –Over and +Over, respectively.
- Computation channel (/M1 option): Displays values in the range of –9999999 to 99999999.

Channel number

Displayed with 1 character as follows:

Measurement channels:1, 2, 3, 4, 5, 6

Computation channels:A, B, C, D, E, F, G, J, K, M, N, P

Alarm

Alarms are displayed using the symbols below. If multiple alarms are occurring simultaneously, the alarm with higher precedence is shown.

(Higher precedence) H, L, T, t, h, l, R, r (Lower precedence)

Special values

Measurement channel

Status	Display	Description
+Over	+Over	See below.
–Over	–Over	See below.
Skip	SKIP	A value for channels set to skip.
Error	ERROR	Values such as when both the reference channel and measurement channel are +Over or –Over in delta computation.
+Burnout	B.out	A value displayed when a burnout is detected on a channel set to burnout up scale.
–Burnout	B.out	A value displayed when a burnout is detected on a channel set to burnout down scale.

+Over and –Over of measurement channels

A condition in which the value is outside the display range indicated in “Measured value or computed value” above. For example,

- For 2 V range, values below –2.200 V are –Over and values over 2.200 V are +Over.

- For TC R, values below –10.0°C are –Over and values over 1770.0°C are +Over.

- If scaled to 0.0 to 100.0, values below –5.0 are –Over and values above 105.0 are +Over.

However, the displayable range during scaling is from –19999 to 31500 (excluding the decimal). Values below –19999 and values above 31500 are displayed as –Over and +Over, respectively.

Computation channel

Status	Display	Description
+Over	+Over	When the computed result exceeds 99999999.
–Over	–Over	When the computed results is less than –9999999.
OFF	SKIP	A value for channels set to Off.







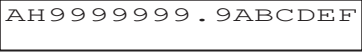

Item	Specifications								
Channel switching interval	The switching interval of displayed channels can be set to 1 s, 2 s, 3 s, 4 s, or 5 s.								
Bar graph display	Displays the measured value on a bargraph.								
Relationship between the digital display and bargraph	Displays the same channel on the digital display and bargraph. On the 2CH digital + 2CH bargraph display, the top bargraph is the left digital display channel and the bottom graph is the right digital display channel.								
Scale	Displays 10 equally spaced scale marks.								
Alarm point mark	For a channel set to delta computation, the alarm point marks of h and l are displayed. For all other channels, the alarm point marks of H, L, T, and t are displayed. <ul style="list-style-type: none"> Blinks on the bargraph when an alarm occurs. Stops blinking when the alarm is released. 								
Bar graph display mode	Selectable from the two modes below. <ul style="list-style-type: none"> Set the base point of the bargraph to the left or right of the recording span whichever is smaller in value. Set the base point of the bargraph to the 50% position of the recording span. 								
Flag display	Displays measured values using flags.								
Display channel	The flag can be turned ON/OFF for each channel. Flag (If flags overlap, the channel with the smallest number is displayed on top)								
Scale	Displays 10 equally spaced scale marks.								
Channel alarm status display	Lists the alarm status of all channels using the symbols below. <table border="1"> <thead> <tr> <th>Symbol</th> <th>Description</th> </tr> </thead> <tbody> <tr> <td>•</td> <td>Alarm is not set.</td> </tr> <tr> <td>–</td> <td>Alarm is not occurring.</td> </tr> <tr> <td>Channel number</td> <td>Alarm is occurring. Displays the channel number when an alarm occurs and clears when the alarm is released. If the alarm indication is set to hold operation, the indicator blinks when an alarm occurs. When alarm ACK operation is performed, the indicator turns ON (stop blinking) or OFF.</td> </tr> </tbody> </table>	Symbol	Description	•	Alarm is not set.	–	Alarm is not occurring.	Channel number	Alarm is occurring. Displays the channel number when an alarm occurs and clears when the alarm is released. If the alarm indication is set to hold operation, the indicator blinks when an alarm occurs. When alarm ACK operation is performed, the indicator turns ON (stop blinking) or OFF.
Symbol	Description								
•	Alarm is not set.								
–	Alarm is not occurring.								
Channel number	Alarm is occurring. Displays the channel number when an alarm occurs and clears when the alarm is released. If the alarm indication is set to hold operation, the indicator blinks when an alarm occurs. When alarm ACK operation is performed, the indicator turns ON (stop blinking) or OFF.								
Date/time and chart speed display	Displays the date/time on the left and chart speed on the right. The date display format can be selected. The format is common with the "Date printout format."								
DI/DO status display	DI:Displays the ON/OFF state of the remote control input terminal (/R1 option). DO:Displays the relay operation (active) of the alarm output terminal (/A1, /A2, or /A3 option).								
Multiple display (display in which different screens can be assigned to the top and bottom sections)	8 display types (see page 12-7) can be assigned to the top and bottom sections of the display (VFD).								
Tag display	Displays 7-digit tags in place of channel numbers. See the digital display and bar graph display sections.								
Status display	Displays the status below. The display condition is the same as the status display under the main display (see page 12-7). Alarm and chart end (/F1 option)								
System display	Displays system information by switching screens every 3 seconds. The main displayed contents are as follows: Analog: Number of inputs Option1, Option2: Options that are installed Math: Number of computation channels Periodic: Periodic printout interval Interval: Trend recording interval (dot model) POC: Pen offset compensation ON/OFF (pen model) MAC address: MAC address Version: Recorder version number (firmware version number)								
Batch name display	Batch name: Batch number (up to 26 characters) and lot number (4 or 6 digit number, or none) (/BT1 option)								
SD memory card status display	Displays the SD memory card status, usage, free space, capacity, volume label, and the remaining length of time for saving data.								
Lights out	Displays nothing.								
Skip	Skips the screen during screen switching.								

12.4 Display Function Specifications

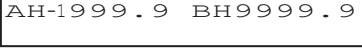
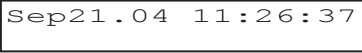
Name	Display Example	Description
1CH digital display	Measurement channel 	Channel number (1 digit), alarm (1 digit), measured value (6 digits), unit (3 digits) Displays using 5 x 7 dots when the unit exceeds 3 digits.
	Computation channel 	
2CH digital display	Measurement channel 	Channel number (1 digit), alarm (1 digit), measured value (7 digits), unit (6 digits)
	Computation channel 	Channel number (1 digit), alarm (1 digit), computed value (9 digits), unit (6 digits)
4CH digital display	Measurement channel 	Channel number (1 digit), alarm (1 digit), measured value (6 digits) Channel number (1 digit), alarm (1 digit), computed value (6 digits) Displayable values are -19999 to 99999 and a decimal. If this range is exceeded, the value is displayed as "-####" or "+####."
	Computation channel 	
6CH digital display (Dot model)		Measured value (5 or 6 digits)
1CH digital + 1CH bargraph display		Channel number (1 digit), alarm (1 digit), measured value (6 digits), unit (3 digits) Bar graph, scale, alarm (bar graph) Value and bar graph of the same channel.
2CH digital + 2CH bargraph display	Measurement channel 	Channel number (1 digit), alarm (1 digit), measured value (6 digits) Bar graph, scale Channel number (1 digit), alarm (1 digit), computed value (6 digits) Bar graph, scale Displayable values are -19999 to 99999 and a decimal. If this range is exceeded, the value is displayed as "-####" or "+####."
	Computation channel 	
1CH digital + 4CH bargraph display (Pen model)	Measurement channel 	Channel number (1 digit), alarm (1 digit), measured value (7 digits), unit (6 digits) Channel number (1 digit), alarm (1 digit), computed value (9 digits), unit (6 digits)
	Computation channel 	
4CH bargraph display (Pen model)		Bar graph, scale
6CH bargraph display (Dot model)		Bar graph, scale
Flag display		Flag, scale
Channel alarm status display		<ul style="list-style-type: none"> • Alarm is not set. - Alarm is not occurring. Channel number Alarm is occurring.
Time/Chart speed display		Displays the date/time on the left and chart speed on the right.

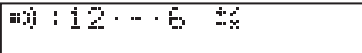
12.4 Display Function Specifications

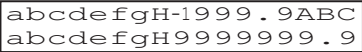
Multiple display (Different screens assigned to the top and bottom sections)

Name	Display Example	Description
1CH digital display	<p>Computation channel</p>  <p>Measurement channel</p> 	<p>Channel number (1 digit), alarm (1 digit), measured value (7 digits), unit (6 digits)</p> <p>Channel number (1 digit), alarm (1 digit), computed value (9 digits), unit (6 digits)</p>
2CH digital display	<p>Computation channel</p>  <p>Measurement channel</p> 	<p>Channel number (1 digit), alarm (1 digit), measured value (6 digits)</p> <p>Channel number (1 digit), alarm (1 digit), measured value (6 digits)</p>
Date/Time		Date/Time
Chart speed		Chart speed
Channel alarm status display	 <p>Alarm summary display  of computation channels</p>	<ul style="list-style-type: none"> • Alarm is not set. - Alarm is not occurring. Channel number Alarm is occurring.
Tag_1CH digital display	 <p>The top section is measurement channel; bottom section is computation channel</p>	The digital display is the same as the Tag_2CH digital display.
Status display		Displays the appropriate mark.
Lights out		No display.

12.5 Specifications of Optional Functions

Alarm Output Relay (/A1, /A2, and /A3)

Item	Specifications
Operation	Outputs relay contact signals from the dedicated terminals on the rear panel when alarms occur.
Number of outputs	2 outputs (/A1), 4 outputs (/A2), 6 outputs (/A3)
Relay contact rating	250 VDC/0.1 A (for resistance load) 250 VAC (50/60 Hz)/3 A
Output format	NO-C-NC
Auxiliary functions	Energized/De-energized operation selectable (common to all relays) Hold/Non-hold operation selectable (common to all relays) AND/OR operation selectable Reflash operation (Fixed to relay I01, I02, and I03. Relay release time is approx. 500 ms.)
Diagnosis output	Relay I01 can be used for diagnosis output. Diagnosis output: Outputs a relay signal when an error in the recording section (plotter on the pen model), a burnout, or an error in the A/D converter is detected. Relay operation is fixed to de-energized and non-hold.

RS-422A/485 Communication Interface (/C3)

Item	Specifications
Connection	Complies with EIA RS-422A/485
Connection type	Multi-drop connection 1:32 (four-wire system), 1:31 (two-wire system, version 1.11 and later)
Transmission mode	Half-duplex
Synchronization	Start-stop synchronization
Baud rate	1200, 2400, 4800, 9600, 19200, or 38400 bps
Start bit	Fixed to 1 bit
Data length	7 bits or 8 bits
Stop bit	Fixed to 1 bit
Parity	Odd, even, or none (no parity)
Received buffer length	2047 bytes
Escape sequence	Open and close
Protocol	Dedicated protocol, Modbus slave protocol (version 1.11 and later)
Communication mode	ASCII for input/output for control and setting ASCII or binary for input/output of measured data
Communication distance	1.2 km

Ethernet Communication Interface (/C7)

Item	Specifications																								
Function	<p>Setting/Measurement server Uses a dedicated protocol Measured/computed data, setup data, status byte</p> <p>Maintenance/Test server Connection information, network statistics, etc.</p> <p>Instrument information server Model, serial number, etc.</p> <p>Electrical and mechanical specifications Conforms to IEEE 802.3.</p>																								
Interface	<p>Basic specifications</p> <p>Connection Ethernet (10BASE-T)</p> <p>Protocol TCP, IP, UDP, ICMP, and ARP</p> <p>The maximum number of simultaneous connections and the number of simultaneous use</p> <table border="1"> <thead> <tr> <th>Function</th> <th>Maximum Number of Administrators</th> <th>Maximum Number of Connections</th> <th>Number of Users</th> <th>Number of Simultaneous Users</th> <th>Port Number</th> </tr> </thead> <tbody> <tr> <td>Setting/Measurement server</td> <td>3</td> <td>3</td> <td>1</td> <td>1</td> <td>34260/tcp</td> </tr> <tr> <td>Maintenance/Test server</td> <td>1</td> <td>1</td> <td>1</td> <td>1</td> <td>34261/tcp</td> </tr> <tr> <td>Instrument information server</td> <td>-</td> <td>-</td> <td>-</td> <td>-</td> <td>34264/udp</td> </tr> </tbody> </table>	Function	Maximum Number of Administrators	Maximum Number of Connections	Number of Users	Number of Simultaneous Users	Port Number	Setting/Measurement server	3	3	1	1	34260/tcp	Maintenance/Test server	1	1	1	1	34261/tcp	Instrument information server	-	-	-	-	34264/udp
Function	Maximum Number of Administrators	Maximum Number of Connections	Number of Users	Number of Simultaneous Users	Port Number																				
Setting/Measurement server	3	3	1	1	34260/tcp																				
Maintenance/Test server	1	1	1	1	34261/tcp																				
Instrument information server	-	-	-	-	34264/udp																				
Miscellaneous	<p>User authentication Administrator: 1, users: 6 (limitations placed on users)</p> <p>Keepalive Drops the connection if there is no response to an inspection packet. Use or not use is selectable.</p>																								

12.5 Specifications of Optional Functions

FAIL/Chart End Detection and Output (/F1)

Item	Specifications
FAIL output	Relay output on CPU error
Relay operation	Energized during normal operation and de-energized on CPU error. Non-hold operation.
Chart end detection output	Stops recording and outputs a relay signal when the remaining amount of chart paper is approx. 2 cm. Also, turns ON the words CHART END on the display.
Relay operation	The relay is energized when the above conditions are met. Non-hold operation.
Contact rating	250 VAC (50/60 Hz)/3 A, 250 VDC/0.1 A (for resistor load)

Clamped Input Terminal (/H2)

Item	Specifications
Measuring input terminal	Uses clamped input terminals.

Non-Glare Door Glass (/H3)

Item	Specifications
Door glass	Uses a door glass with minimal reflection.

Computation Function (/M1)

Item	Specifications								
Number of computation channels	Pen model: 8 channels, dot model: 12 channels								
Operation	General arithmetic operations: Four arithmetic operations, square root, absolute, common logarithm, exponential, power, relational operations (<, ≤, >, ≥, =, ≠), logical operations (AND, OR, NOT, XOR)								
Constants	Statistical operations (TLOG): Average, max., min., sum, and max. – min. for each interval Up to 30 constants can be defined Range: –9.9999E+29 to –1.0000E–30, 0, 1.0000E–30 to 9.9999E+29 Symbol: K01 to K30								
Communication input data	Digital data via communication can be used in computations other than statistical computation (TLOG) Number of communication input data points: 8 (pen model), 12 (dot model) Range: –9.9999E+29 to –1.0000E–30, 0, 1.0000E–30 to 9.9999E+29 Symbol: C01 to C12								
Remote input	Use remote input status (0/1) in equations Number of inputs: 5 Symbol: D01 to D05								
Computation accuracy	32-bit floating-point computation (excluding TLOG computation)								
Computation range	Computed values throughout the computation remains within approx. $\pm 3.4 \times 10^{38}$.								
Equation	Defined using up to 120 characters.								
Execution interval	Scan interval								
TLOG timer	Performs statistical calculation for each interval specified by the timer.								
Number of timers	3 (periodic printout timer, timer 1, and timer 2).								
Timer 1 and 2 modes	Absolute or relative								
Reset	TLOG data can be reset at each interval.								
Printout	Printout at each interval is possible.								
Trend recording									
Recording span	–9999999 to 99999999, decimal place arbitrary.								
Unit	Up to 6 characters								
Recording methods	Zone recording and partial expanded recording available.								
Pen	Measurement channels and computation channels can be assigned arbitrarily to pens.								
Dot printing	Trend recording of measurement and computation channels. The fastest dot printing interval is as follows:								
	<table border="1"> <thead> <tr> <th>Number of channels being trend recorded</th> <th>Fastest dot printing interval</th> </tr> </thead> <tbody> <tr> <td>6 or less</td> <td>10 s</td> </tr> <tr> <td>7 to 12</td> <td>15 s</td> </tr> <tr> <td>13 to 18</td> <td>20 s</td> </tr> </tbody> </table>	Number of channels being trend recorded	Fastest dot printing interval	6 or less	10 s	7 to 12	15 s	13 to 18	20 s
Number of channels being trend recorded	Fastest dot printing interval								
6 or less	10 s								
7 to 12	15 s								
13 to 18	20 s								

Item	Specifications
Alarms	
Number of alarms	Up to four alarms (level) for each measurement channels.
Alarm types	High limit (H), low limit (L), delay high limit (T), delay low limit (t). The alarm symbol is shown in parentheses. Alarm delay time of delay high and low limit alarms (can be set for each channel, common within a channel) See section 12.2
Hysteresis	Applied to high limit alarm and low limit alarm. Hysteresis range: Approx. 0.0% to 1.0% of the recording span (0.1% steps)
Miscellaneous	See section 12.2.
Display	See section 12.4.

Cu10, Cu25 RTD Input (/N1)

Item	Specifications												
Cu10, Cu25 RTD	This option allows Cu10 and Cu25 inputs to be added to the standard input types.												
Input type and measurable range													
	<table border="1"> <thead> <tr> <th>Input Type</th> <th>Measurable Range</th> </tr> </thead> <tbody> <tr> <td rowspan="6">RTD (Measurement current i: 2 mA)</td> <td>Cu10 (GE)</td> <td rowspan="6">-200.0 to 300.0°C -328.0 to 572.0°F</td> </tr> <tr> <td>Cu10 (L&N)</td> </tr> <tr> <td>Cu10 (WEED)</td> </tr> <tr> <td>Cu10 (BAILEY)</td> </tr> <tr> <td>Cu10: $\alpha = 0.00392$ at 20°C</td> </tr> <tr> <td>Cu10: $\alpha = 0.00393$ at 20°C</td> </tr> <tr> <td>Cu25*: $\alpha = 0.00425$ at 0°C</td> <td></td> </tr> </tbody> </table>	Input Type	Measurable Range	RTD (Measurement current i: 2 mA)	Cu10 (GE)	-200.0 to 300.0°C -328.0 to 572.0°F	Cu10 (L&N)	Cu10 (WEED)	Cu10 (BAILEY)	Cu10: $\alpha = 0.00392$ at 20°C	Cu10: $\alpha = 0.00393$ at 20°C	Cu25*: $\alpha = 0.00425$ at 0°C	
Input Type	Measurable Range												
RTD (Measurement current i: 2 mA)	Cu10 (GE)	-200.0 to 300.0°C -328.0 to 572.0°F											
	Cu10 (L&N)												
	Cu10 (WEED)												
	Cu10 (BAILEY)												
	Cu10: $\alpha = 0.00392$ at 20°C												
	Cu10: $\alpha = 0.00393$ at 20°C												
Cu25*: $\alpha = 0.00425$ at 0°C													

* Measurement current $i = 1$ mA

Measurement and recording accuracy

Input Type	Measurement Accuracy	Recording Accuracy
Cu10 (GE) Cu10 (L&N) Cu10 (WEED) Cu10 (BAILEY) Cu10: $\alpha = 0.00392$ at 20°C Cu10: $\alpha = 0.00393$ at 20°C	$\pm(0.4\%$ of rdg + 1.0°C)	Measurement accuracy $\pm(0.3\%$ of recording span)
Cu25: $\alpha = 0.00425$ at 0°C	$\pm(0.3\%$ of rdg + 0.8°C)	

3 Legs Isolated RTD (/N2)

Item	Specifications
Input terminal isolation	Applies to the dot model. The RTD input terminals are isolated between channels (on the standard dot model, input terminal b are common to all channels)

Expansion Inputs (/N3)

Item	Specifications																																															
Input type and measurable range	Adds the input types shown in the table below.																																															
	<table border="1"> <thead> <tr> <th>Input Type</th> <th colspan="2">Measurable Range</th> </tr> </thead> <tbody> <tr> <td rowspan="6">Thermocouple</td> <td>PR40-20</td> <td>0.0 to 1900.0°C</td> <td>32 to 3452°F</td> </tr> <tr> <td>PLATINEL</td> <td>0.0 to 1400.0°C</td> <td>32 to 2552°F</td> </tr> <tr> <td>NiNiMo</td> <td>0.0 to 1310.0°C</td> <td>32 to 2390°F</td> </tr> <tr> <td>W/WRe26</td> <td>0.0 to 2400.0°C</td> <td>32 to 4352°F</td> </tr> <tr> <td>Type N (AWG14)</td> <td>0.0 to 1300.0°C</td> <td>32 to 2372°F</td> </tr> <tr> <td>Kp vs Au7Fe</td> <td>0.0 to 300.0 K</td> <td></td> </tr> <tr> <td rowspan="8">RTD (Measuring current i = 1 mA)</td> <td>Pt25</td> <td>-200.0 to 550.0°C</td> <td>-328.0 to 1022.0°F</td> </tr> <tr> <td>Pt50</td> <td>-200.0 to 600.0°C</td> <td>-328.0 to 1112.0°F</td> </tr> <tr> <td>Ni100 (SAMA)</td> <td>-200.0 to 250.0°C</td> <td>-328.0 to 482.0°F</td> </tr> <tr> <td>Ni100 (DIN)</td> <td>-60.0 to 180.0°C</td> <td>-76.0 to 356.0°F</td> </tr> <tr> <td>Ni120</td> <td>-70.0 to 200.0°C</td> <td>-94.0 to 392.0°F</td> </tr> <tr> <td>J263*B</td> <td>0.0 to 300.0 K</td> <td></td> </tr> <tr> <td>Cu53</td> <td>-50.0 to 150.0°C</td> <td>-58.0 to 302.0°F</td> </tr> <tr> <td>Cu100: $\alpha = 0.00425$ at 0°C</td> <td>-50.0 to 150.0°C</td> <td>-58.0 to 302.0°F</td> </tr> </tbody> </table>	Input Type	Measurable Range		Thermocouple	PR40-20	0.0 to 1900.0°C	32 to 3452°F	PLATINEL	0.0 to 1400.0°C	32 to 2552°F	NiNiMo	0.0 to 1310.0°C	32 to 2390°F	W/WRe26	0.0 to 2400.0°C	32 to 4352°F	Type N (AWG14)	0.0 to 1300.0°C	32 to 2372°F	Kp vs Au7Fe	0.0 to 300.0 K		RTD (Measuring current i = 1 mA)	Pt25	-200.0 to 550.0°C	-328.0 to 1022.0°F	Pt50	-200.0 to 600.0°C	-328.0 to 1112.0°F	Ni100 (SAMA)	-200.0 to 250.0°C	-328.0 to 482.0°F	Ni100 (DIN)	-60.0 to 180.0°C	-76.0 to 356.0°F	Ni120	-70.0 to 200.0°C	-94.0 to 392.0°F	J263*B	0.0 to 300.0 K		Cu53	-50.0 to 150.0°C	-58.0 to 302.0°F	Cu100: $\alpha = 0.00425$ at 0°C	-50.0 to 150.0°C	-58.0 to 302.0°F
Input Type	Measurable Range																																															
Thermocouple	PR40-20	0.0 to 1900.0°C	32 to 3452°F																																													
	PLATINEL	0.0 to 1400.0°C	32 to 2552°F																																													
	NiNiMo	0.0 to 1310.0°C	32 to 2390°F																																													
	W/WRe26	0.0 to 2400.0°C	32 to 4352°F																																													
	Type N (AWG14)	0.0 to 1300.0°C	32 to 2372°F																																													
	Kp vs Au7Fe	0.0 to 300.0 K																																														
RTD (Measuring current i = 1 mA)	Pt25	-200.0 to 550.0°C	-328.0 to 1022.0°F																																													
	Pt50	-200.0 to 600.0°C	-328.0 to 1112.0°F																																													
	Ni100 (SAMA)	-200.0 to 250.0°C	-328.0 to 482.0°F																																													
	Ni100 (DIN)	-60.0 to 180.0°C	-76.0 to 356.0°F																																													
	Ni120	-70.0 to 200.0°C	-94.0 to 392.0°F																																													
	J263*B	0.0 to 300.0 K																																														
	Cu53	-50.0 to 150.0°C	-58.0 to 302.0°F																																													
	Cu100: $\alpha = 0.00425$ at 0°C	-50.0 to 150.0°C	-58.0 to 302.0°F																																													

12.5 Specifications of Optional Functions

Item	Specifications		
Measurement and recording accuracy: See "Standard Performance" on page 12-20.			
	Input Type	Measurement Accuracy	Recording Accuracy
Thermocouple (excludes RJC accuracy)	PR40-20	0 to 450°C	Not warranted ±(0.9% of rdg + 3.2°C) ±(0.9% of rdg + 1.3°C) ±(0.9% of rdg + 0.4°C)
		450 to 750°C	
		750 to 1100°C	
		1100 to 1900°C	
	PLATINEL		±(0.25% of rdg + 2.3°C)
	NiNiMo		±(0.25% of rdg + 0.7°C)
RTD	W/WRe26	0 to 400°C	±15.0°C or less ±(0.2% of rdg + 2.0°C)
		400 to 2400°C	
	Type N (AWG14)		±(0.2% of rdg + 1.3°C)
	Kp vs Au7Fe	0 to 20 K	±4.5 K ±2.5 K
		20 to 300 K	
	Pt25		±(0.15% of rdg + 0.6°C)
	Pt50		±(0.3% of rdg + 0.6°C)
	Ni100 (SAMA)		±(0.15% of rdg + 0.4°C)
	Ni100 (DIN)		
	Ni120		
J263*B	0 to 40 K	±3.0 K ±1.0 K	
	40 to 300 K		
Cu53		±(0.15% of rdg + 0.8°C)	
Cu100		±(0.2% of rdg + 1.0°C)	
Reference junction compensation accuracy	When input terminal temperature balanced (60 minutes after power on) PLATINEL, NiNiMo, W/WRe26, or Type N (AWG14): ±1.0°C No RJC for PR40-20 and Kp vs Au7Fe (fixed to 0°C)		

Remote Control 5 Points (/R1)

Item	Specifications
Number of input terminals	5
Input type	Isolated from the main circuitry through a photocoupler, built-in isolated power supply for the input terminals, and shared common
Input type and signal level	
Voltage-free contact	Contact closed at 200 Ω or less and contact open at 100 kΩ or greater
Open collector	ON voltage: 0.5 V or less (sink current 30 mA or more), leakage current when OFF: 0.25 mA or less
Allowable input voltage	5 VDC
Signal type	Edge, level, or trigger (250 ms or more)
Operation	Perform the following control operations by applying a given signal to the remote signal input terminal. <ul style="list-style-type: none"> • Start/stop recording (edge) • Alarm ACK (trigger) • Set the clock (adjust the clock to the nearest hour with the contact input, trigger)
Time When Signal Is Input Procedure	
00 min 00 s to 01 min 59 s	Truncates the minutes and seconds.Example: 10:00:50 → 10:00:00
58 min 00 s to 59 min 59 s	Rounds up the minutes and seconds.Example: 10:59:50 → 11:00:00
02 min 00 s to 57 min to 59 s	No operation
	<ul style="list-style-type: none"> • Manual printout (trigger) • Message 1 to 5 printout (trigger) • Switch the chart speed (level) • Start/stop computation (/M1 option) (edge) • Reset computation (/M1 option) (trigger) • Priority to remote recording (/BT1 option) (edge) • Batch comment switching (/BT1 option) (level) • Start/stop data saving (/EM1 option) (edge)

Portable Type (/H5x)

Item	Specifications
Installation	Desktop type (with a carrying handle)
External dimensions	144 (W) × 187 (H) × 285 (D) mm (including the handle and feet)
Weight	Add 1.0 kg to the weight given in General Specifications (see section 12.6, excluding the power cord)
Standard accessories*	With a power cord

* Panel mounting brackets are not included.

24 VDC/AC Power Supply Operation (/P1)

Item	Specifications												
Rated supply voltage	24 VDC/AC												
Allowable power supply voltage range	21.6 to 26.4 VDC/AC												
Withstand voltage	1000 VAC at 50/60 Hz for one minute (between the power terminal and the ground terminal)												
Rated power supply frequency	50/60 Hz (for AC operation)												
Allowable power supply frequency range	50 Hz \pm 2% or 60 Hz \pm 2% (for AC operation)												
Effects of power supply voltage fluctuation	The fluctuation in the measured values is within ± 1 digit and that in the recording is within $\pm 0.1\%$ in the recording span for the 21.6 to 26.4 VAC/DC range.												
Effects of power supply frequency fluctuation	The fluctuation in the measured values and recording is $\pm(0.1\%$ of rdg + 1 digit) at the rated frequency ± 2 Hz.												
Rated power	25 VA (for DC) or 35 VA (for AC)												
Power consumption													
	<table border="1"> <thead> <tr> <th>Model</th> <th>24 VDC</th> <th>24 VAC</th> <th>Maximum</th> </tr> </thead> <tbody> <tr> <td>1 to 4 pen models</td> <td>Approx. 7 VA*</td> <td>Approx. 13 VA*</td> <td>Approx. 35 VA</td> </tr> <tr> <td>6 dot model</td> <td>Approx. 8 VA*</td> <td>Approx. 13 VA*</td> <td>Approx. 35 VA</td> </tr> </tbody> </table>	Model	24 VDC	24 VAC	Maximum	1 to 4 pen models	Approx. 7 VA*	Approx. 13 VA*	Approx. 35 VA	6 dot model	Approx. 8 VA*	Approx. 13 VA*	Approx. 35 VA
Model	24 VDC	24 VAC	Maximum										
1 to 4 pen models	Approx. 7 VA*	Approx. 13 VA*	Approx. 35 VA										
6 dot model	Approx. 8 VA*	Approx. 13 VA*	Approx. 35 VA										
	* When balanced												

Calibration Correction (/CC1)

Item	Specifications
Number of calibration points	2 to 16 (can be specified for each channel)
Correction mode	Revise or absolute value (can be specified for each channel)
Correctable range	DC input (DC voltage, TC, and RTD) and linear scaling (DC voltage, TC, RTD, and 1-5V) (Not allowed on ON/OFF input (including linear scaling), delta computation, square root computation, and computation channels)
Correction range	<ul style="list-style-type: none"> $(1^{\text{st}} \text{ correction point} + 1^{\text{st}} \text{ correction value}) < (2^{\text{nd}} \text{ correction point} + 2^{\text{nd}} \text{ correction value}) < \dots$ Corrected value (revise value: correction point + correction value, absolute value: correction value) within the measurable range and scaling range (-5% to 105% or -20000 to 30000) of each input range Setting limits <ul style="list-style-type: none"> Left span (0%) < Right span (100%) Left scale (0%) < Right scale (100%)
Others	Calibration correction and bias functions cannot be used simultaneously (common to all channels)

Header Printout (/BT1)

Item	Specifications
Printout function	When recording starts or stops, prints out the batch name, comment, date/time, and chart speed. Messages can also be printed out including measured values*.
Printed items	
Recording start/recording end printouts	Batch name: Batch number (up to 26 characters) and lot number (4 or 6 digit number, or Off) Comment (up to 32 characters x 5 lines) Chart speed Date/time: Year, month, date, time, minute, second (date format depends on the date printout/display format) Printout On/Off selection: Batch name, chart speed, and date/time
Message printouts	In the 5 message formats, measured values*, strings (up to 16 characters), and date/time can be arbitrarily combined and printed out (up to 35 characters total).
	* Computed values can also be included on models with the /M1 option.

SD Memory Card (/EM1)

Item	Specifications
Measured data save	Saves measured data to the SD memory card. File is divided every about 30 MB. .RXE extension.
Measured data replay	Universal Viewer (software) for viewing and printing. Data saved with a dot model to an SD memory card can be replayed on chart paper using a recorder of the same model with equivalent or more functions.
Setting parameters save and load	Saves recorder setup data to an SD memory card. .PUL extension. Loads setup data from an SD memory card into the recorder.

12.6 General Specifications

Construction

Item	Specifications
Mounting	Flush panel mounting (on a vertical plane)
Mounting angle	Inclined backward up to 30 degrees from a horizontal plane.
Allowable panel thickness	2 to 26 mm
Material	Case: drawn steel Front door: Aluminum die-cast
Color	Case: Charcoal gray light (Munsell 10B3.6/0.3 or equivalent) Front door: Charcoal gray light (Munsell 10B3.6/0.3 or equivalent)
Front panel	Water and dust-proof (complies with DIN40050-IP54)
Dimensions	144(W) × 144(H) × 220(D) mm (D: depth from the panel mounting plane)
Weight	1-pen: approx. 2.1 kg, 2-pen: approx. 2.2 kg, 3-pen: approx. 2.3 kg, 4-pen: approx. 2.4 kg 6-dot: approx. 2.5 kg

Normal Operating Conditions

Item	Specifications
Ambient temperature	0 to 50°C
Ambient humidity	20 to 80%RH (at 5 to 40°C) 30 to 50%RH (at 0 to 5, 40 to 50°C)
Allowable power supply voltage range	90 to 264 VAC
Power supply frequency	50 Hz ±2%, 60 Hz ±2%
Vibration	10 to 60 Hz 0.2 m/s ² or less
Shock	Not acceptable.
Magnetic field	400 A/m or less (DC and 50/60 Hz)
Noise	Normal mode (50/60 Hz) Volt: The peak value including the signal must be less than 1.2 times the rated value of the range (Example: 2 V for 2 V range). TC: The peak value including the signal must be less than 1.2 times the rated value of the range. RTD: 50 mV or less Common mode (50/60 Hz): Less than 30 VACrms or 60 VDC for the whole range. Maximum noise voltage between channels (50/60 Hz): 250 VACrms or less. 6-dot model with the 3 legs isolated RTD (/N2 option) installed: 200 VACrms or less.
Mounting position	Up to 30° of backward tilt angle allowed, no tilt to the left or right
Warm-up time	At least 30 minutes after power on
Altitude	2000 m or less above sea level

Power Supply

Item	Specifications												
Rated supply voltage	100 to 240 VAC												
Allowable power supply voltage range	90 to 264 VAC												
Rated power supply frequency	50 Hz, 60 Hz												
Rated power	Pen model: 40 VA, dot model: 40 VA												
Power consumption	<table border="1"> <thead> <tr> <th>Model</th> <th>100 VAC</th> <th>240 VAC</th> <th>Maximum</th> </tr> </thead> <tbody> <tr> <td>1- to 4-pen model</td> <td>Approx. 12 VA*</td> <td>Approx. 17 VA*</td> <td>Approx. 40 VA</td> </tr> <tr> <td>6-dot model</td> <td>Approx. 13 VA*</td> <td>Approx. 18 VA*</td> <td>Approx. 40 VA</td> </tr> </tbody> </table>	Model	100 VAC	240 VAC	Maximum	1- to 4-pen model	Approx. 12 VA*	Approx. 17 VA*	Approx. 40 VA	6-dot model	Approx. 13 VA*	Approx. 18 VA*	Approx. 40 VA
Model	100 VAC	240 VAC	Maximum										
1- to 4-pen model	Approx. 12 VA*	Approx. 17 VA*	Approx. 40 VA										
6-dot model	Approx. 13 VA*	Approx. 18 VA*	Approx. 40 VA										
	* When balanced												

Isolation

Item	Specifications
Insulation resistance	Each terminal to ground terminal: 20 M Ω or more (at 500 VDC)
Dielectric strength	Power supply to ground terminal: 1500 VAC (50/60 Hz), 1 minute Contact output terminal to ground terminal: 1500 VAC (50/60 Hz), 1 minute Measuring input terminal to ground terminal: 1000 VAC (50/60 Hz), 1 minute Between measuring input terminals: 1000 VAC (50/60 Hz), 1 minute (except for RTD input terminal) Remote input terminal to ground terminal: 500 VDC, 1 minute
Grounding	Be sure to set a low grounding resistance.

Transport and Storage Conditions

Item	Specifications
Ambient temperature	-25 to 60°C
Ambient humidity	5 to 95%RH (no condensation)
Vibration	10 to 60 Hz, 4.9 m/s ² maximum
Shock	392 m/s ² maximum (in packaged condition)

Supported Standards

Item	Specifications
CSA	Certified by CAN/CSA-C22.2 No. 61010-1, CSA-C22.2 No. 61010-2-030, Overvoltage Category II or I ¹ , Measurement Category II ² , Pollution Degree 2 ³
UL	UL 61010-1, UL Std. No. 61010-2-030 (CSA NRTL/C) Overvoltage Category II or I ¹ , Measurement Category II ² , Pollution, Degree 2 ³
CE, UKCA	
EMC directive	EN 61326-1 Class A, Table 2 (For use in industrial locations) compliant EN 61000-3-2 compliant EN IEC 61000-3-2 compliant EN 61000-3-3 compliant EN 55011 Class A Group 1 compliant
Low voltage directive	EN 61010-1, EN IEC 61010-2-030 compliant, Overvoltage Category II or I ¹ , Measurement Category II ² , Pollution Degree 2 ³
EU RoHS directive	EN IEC 63000 compliant
WEEE directive	Compliant
EMC regulatory arrangement in Australia and New Zealand (RCM)	EN 55011 Class A Group 1 compliant
KC marking	KS C9811, KS C9610-6-2 compliant

- 1 Overvoltage category describes a number which defines a transient overvoltage condition. It implies the regulation for impulse withstand voltage. Applies to electrical equipment which is supplied from the fixed installation like a distribution board.
II: Applied to standard power supply (100-240 VAC)
I: Applied to /P1 option (24 VDC/AC)
- 2 Applies to measuring circuits connected to low voltage installation, and electrical instruments supplied with power from fixed equipment such as electric switchboards.
- 3 "Pollution degree" describes the degree to which a solid, liquid, or gas which deteriorates dielectric strength or surface resistivity is adhering. "2" applies to normal indoor atmosphere. Normally, only non-conductive pollution occurs.

12.6 General Specifications

Standard Performance

Item	Specifications
Measurement and recording accuracy	The following specifications apply to operation of the recorder under standard operation conditions: Temperature: 23 ± 2°C Humidity: 55% ± 10%RH Power supply voltage: 90 to 132 or 180 to 264 VAC Power supply frequency: 50/60 Hz ± 1% Warm-up time: At least 30 minutes. Other ambient conditions such as vibration should not adversely affect the operation

Input Type	Range Type	Measurement (Digital Display)		Recording (Trend)	
		Measurement Accuracy	Highest Res.	Recording Accuracy	Resolution
DC voltage	20 mV	±(0.1% of rdg + 2 digits)	10 µV	Measurement accuracy ±(0.3% of recording span)	Pen model: Dead band 0.2% of recording span Dot model: Resolution 0.1 mm
	60 mV		10 µV		
	200 mV		100 µV		
	2 V		1 mV		
	6 V		1 mV		
	20 V		10 mV		
DC voltage	1-5 V	±(0.1% of rdg + 2 digits)	1 mV		
TC (excludes RJC accuracy)	R S B	±(0.15% of rdg + 1) except R,S: 0 to 100°C, ±3.7°C 100 to 300°C, ±1.5°C B: 400 to 600°C, ±2°C Accuracy not warranted for values less than 400°C	0.1°C		
	K	±(0.15% of rdg + 0.7°C) except ±(0.15% of rdg + 1°C) for -200 to -100°C			
	E J T	±(0.15% of rdg + 0.5°C) except ±(0.15% of rdg + 0.7°C) for J: -200 to -100°C			
	N	±(0.15% of rdg + 0.7°C)			
	W	±(0.15% of rdg + 1°C)			
	L U	±(0.15% of rdg + 0.5°C) except ±(0.15% of rdg + 0.7°C) for L: -200 to -100°C			
	WRe	±(0.2% of rdg + 1°C)			
RTD	Pt100 JPt100	±(0.15% of rdg + 0.3°C)			
ON/OFF input	Level Contact	Threshold level (2.4 V) accuracy ± 0.1 V ≤ 1 kΩ: ON, ≥ 100 kΩ: OFF (Parallel capacitance 0.01 µF or less)	-	-	

Measuring accuracy in case of linear scaling

Accuracy during scaling (digits) = measuring accuracy (digits) × multiplier + 2 digits (rounded up) where the multiplier = scaling span (digits)/measuring span (digits).

Example: Assuming that

- range type: 1-5 V
- measuring span: 1.000 to 5.000 V
- scaling span: 0.000 to 2.000 Then,
 Measuring accuracy = ±(0.1% × 5 V + 2 digits)
 when the input is 5 V = ±(0.005 V [5 digits] + 2 digits)
 = ±7 digits

Multiplier = {2000 digits (0.000 to 2.000)}/4000 digits (1.000 to 5.000) = 0.5
 Accuracy during scaling = ±(7 × 0.5 + 2) digits = ±6 digits (rounded up)

Item	Specifications												
Measuring accuracy and recording accuracy in case of square root computation	<p>A: Voltage measurement accuracy (digits) B: Voltage span (digits) C: Scaling span (digits, upper limit of scaling – lower limit of scaling)</p> <table border="1"> <thead> <tr> <th>Input Range</th> <th>Computed Value Accuracy Equation (Digits), Rounded up to the decimal place</th> <th>Recording Accuracy</th> </tr> </thead> <tbody> <tr> <td>0% or more, less than 1.5%*</td> <td>$\pm(0.1 \times C + 2)$</td> <td rowspan="4">Left value + 0.3% of recording span</td> </tr> <tr> <td>1.5% or more, less than 6.25%</td> <td>$\pm(A / B \times C \times 5 + 2)$</td> </tr> <tr> <td>6.25% or more, less than 25%</td> <td>$\pm(A / B \times C \times 2 + 2)$</td> </tr> <tr> <td>25% or more, 100% or less</td> <td>$\pm(A / B \times C + 2)$</td> </tr> </tbody> </table> <p>* Includes case when: (input voltage – lower limit of the specified voltage range) / used range $\times 20000 < 256$. If the specified range is, for example, 1–5 V, the lower limit of the specified voltage range is 1. Use a measurement range that is as close to the measurement span as possible.</p> <p>Example: Assuming that</p> <ul style="list-style-type: none"> range type: 6 V measuring span: 1.000 to 5.000 V scaling span: 0.000 to 2.000 Then, <p>A = A calculated value shown below B = 5.000 V - 1.000 V = 4.000 V (4000 digits) C = 2.000 – 0.000 = 2.000 (2000 digits)</p> <p><Measuring accuracy></p> <p>(1) When the input is 1.24 V (6% input) $A = \pm (0.1\% \times 1.240 \text{ V} + 2 \text{ digits}) = \pm(0.00124 \text{ V}(2 \text{ digits}) + 2 \text{ digits}) = \pm 4 \text{ digits}$ Measuring accuracy = $\pm (4/4000 \times 2000 \times 5+2) = \pm 12 \text{ digits}$</p> <p>(2) When the input is 5 V (100% input) $A = \pm (0.1\% \times 5.000 \text{ V} + 2 \text{ digits}) = \pm(0.005 \text{ V}(5 \text{ digits}) + 2 \text{ digits}) = \pm 7 \text{ digits}$ Measuring accuracy = $\pm (7/4000 \times 2000+2) = \pm 5.5 = \pm 6 \text{ digits (rounded up)}$</p> <p><Recording accuracy> Measuring accuracy $\pm 0.3 \text{ mm (0.3\% of 100 mm)}$</p>	Input Range	Computed Value Accuracy Equation (Digits), Rounded up to the decimal place	Recording Accuracy	0% or more, less than 1.5%*	$\pm(0.1 \times C + 2)$	Left value + 0.3% of recording span	1.5% or more, less than 6.25%	$\pm(A / B \times C \times 5 + 2)$	6.25% or more, less than 25%	$\pm(A / B \times C \times 2 + 2)$	25% or more, 100% or less	$\pm(A / B \times C + 2)$
Input Range	Computed Value Accuracy Equation (Digits), Rounded up to the decimal place	Recording Accuracy											
0% or more, less than 1.5%*	$\pm(0.1 \times C + 2)$	Left value + 0.3% of recording span											
1.5% or more, less than 6.25%	$\pm(A / B \times C \times 5 + 2)$												
6.25% or more, less than 25%	$\pm(A / B \times C \times 2 + 2)$												
25% or more, 100% or less	$\pm(A / B \times C + 2)$												
Reference junction compensation	Internal/External selectable for each channel												
Reference junction compensation accuracy	Above 0°C with input terminal temperature balanced (60 minutes after power on) Type R, S, B, W, WRe: $\pm 1.0^\circ\text{C}$ Type K, J, E, T, N, L, U: $\pm 0.5^\circ\text{C}$												
Maximum input voltage	$\pm 10 \text{ VDC}$ (continuous) for ranges of 200 mV or less, TC, RTD, and DI ranges $\pm 60 \text{ VDC}$ (continuous) for 2 VDC or higher ranges												
Input resistance	Approximately 10 M Ω or more for ranges of 200 mV or less and TC Approximately 1 M Ω for 2 VDC or higher ranges												
Input source resistance	Volt, TC: 2 k Ω or less RTD input: 10 Ω or less per wire (The resistance of all three wires must be equal).												
Input bias current	10 nA or less (except when burnout detection function is enabled)												
Maximum common mode noise voltage	250VACrms (50/60Hz)												
Maximum differential noise between channels	250VACrms (50/60Hz) 200VACrms (50/60Hz, for the mode with /N2 option)												
Interference between channels	120dB (Input external resistance 500 Ω , the deviation in the case that 60V is applied to another channel)												
Common mode rejection ratio	120 dB (50/60 Hz $\pm 0.1\%$, 500 Ω unbalanced, between the minus terminal and ground)												
Normal mode rejection ratio	40 dB or more (50/60 Hz $\pm 0.1\%$)												
Noise rejection	By the integrating A/D converter: The integration time is 16.7 ms, 20 ms, or 100 ms (dot model) Low-pass filtering (pen model): Filter time constant is 2 s, 5 s, or 10 s Moving average (dot model): The number of samples is 2 to 16.												

12.6 General Specifications

Effects of Operating Conditions

Item	Specifications
Ambient temperature	With temperature variation of 10°C: Measurement: $\pm(0.1\%$ of rdg + 1 digit) or less Recording: Measurement fluctuation + $\pm 0.2\%$ of the recording span or less * Excluding the error of reference junction compensation
Power supply fluctuation	With variation within 90 to 132 V and 180 to 264 VAC (50/60 Hz): Measurement: ± 1 digit or less Recording: $\pm 0.1\%$ of the recording span or less With variation of ± 2 Hz from rated power frequency (power supply voltage 90 to 132, 180 to 264 VAC): Measurement: $\pm(0.1\%$ of rdg + 1 digit) or less Recording: Same as the measurement fluctuation
Magnetic field	AC (50/60 Hz) and DC 400 A/m fields: Measurement: $\pm(0.1\%$ of rdg 10 digit) or less Recording: $\pm 0.5\%$ of the recording span or less
Input source resistance	
DC voltage range	With variation of +1 k Ω : Ranges of 200 mV or less: Within ± 10 μ V Ranges of 2V or more: $\pm 0.1\%$ of rdg
TC range	With variation of +1 k Ω : ± 10 μ V or less
RTD range	With variation of 10 Ω per wire (resistance of all three wires must be equal): Measurement: $\pm(0.1\%$ of rdg + 1 digit) or less Recording: Measurement fluctuation + $\pm 0.1\%$ of the recording span or less With maximum difference of 40 m Ω between wires: Approx. 0.1°C (for Pt100)
Mounting position	With a backward tilt of 30° or less Measurement: $\pm(0.1\%$ of rdg + 1 digit) or less Recording: Indication fluctuation + $\pm 0.1\%$ of the recording span or less
Vibration	When a sinusoidal vibration along all three axis at a frequency between 10 to 60 Hz and an acceleration of 0.2 m/s ² is applied for 2 hours Measurement: $\pm(0.1\%$ of rdg + 1 digit) or less Recording: Indication fluctuation + $\pm 0.1\%$ of the recording span or less

Other Specifications

Item	Specifications
Clock	With a calendar function
Accuracy of clock	± 100 ppm, excluding a delay (of 1 second, maximum) caused each time the power is turned on.
DST	The date/time for switching between standard time and DST can be specified.
Memory backup	A built-in lithium battery backs up the setup parameters and runs the clock (battery life: approximately ten years at room temperature).
Key lock function	Password for releasing the key lock can be set.
Key lock items	RCD key, MENU key, DISP MENU key, FEED key, and function under the FUNC key (Alarm ACK, computation start/stop, print, message, printout buffer clear, periodic printout reset, and pen or ribbon cassette exchange, data saving start/stop, data replay start/stop, SD memory card ejection)
Internal light	Lights up the recording area of the chart paper. Uses a dedicated LED.
Noise	Machine Noise Information Ordinance 3.GSGV, Jan 18, 1991 Maximum noise level: 60 dB (A) or less (complies with ISO7779)

12.7 Dimensional Drawings

Panel Mount Type

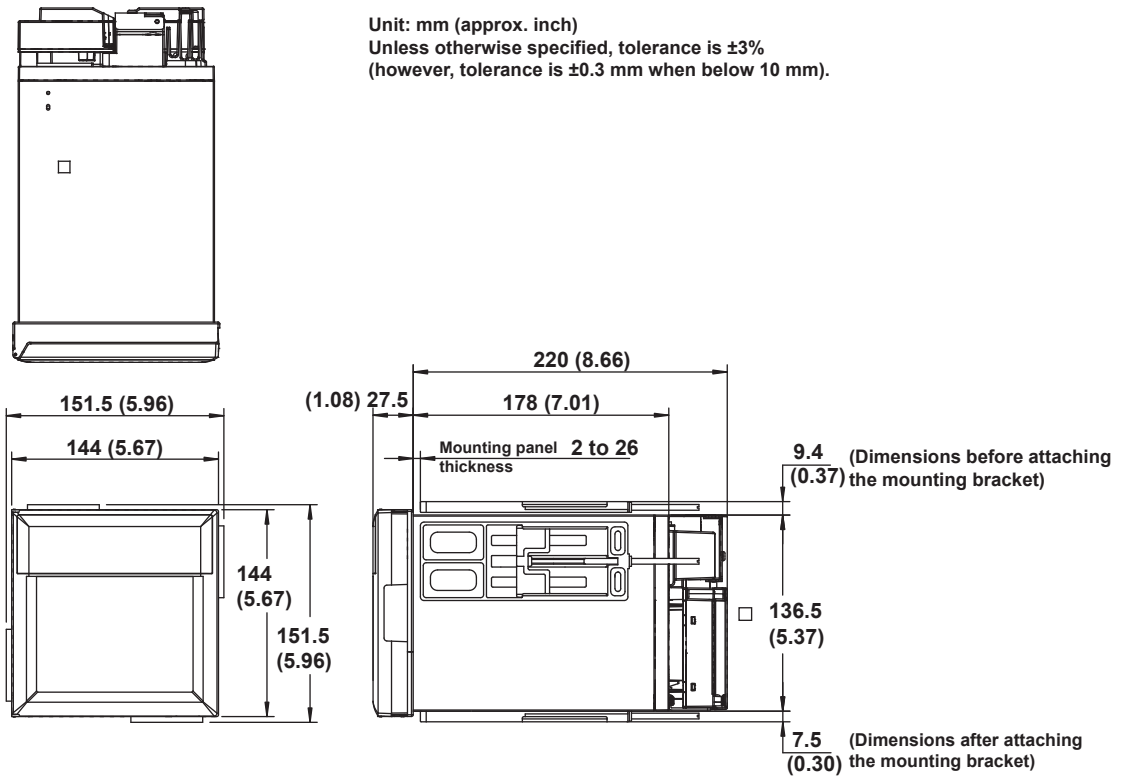

Note

When mounting the recorder to a panel, use two brackets, top and bottom or left and right.

Panel Cut Dimensions

Single-Unit Mounting

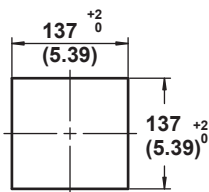

Side-by-Side Mounting (horizontally)

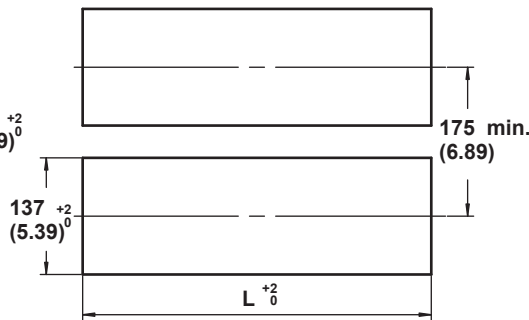

Units	L (mm)
2	282
3	426
4	570
5	714
6	858
7	1002
8	1146
9	1290
10	1434
n	(144xn)-6

Side-by-Side Mounting (vertically, max. 3 units)

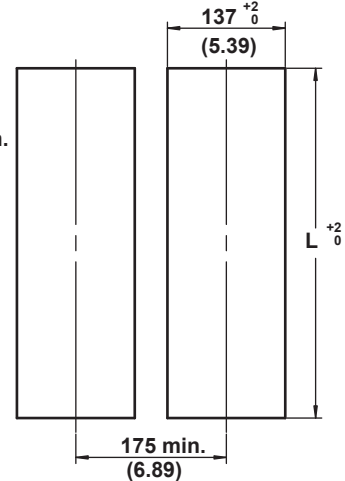

Attach the mounting brackets to the top and bottom when mounting the recorders side-by-side horizontally or right and left when mounting the recorders side-by-side vertically.

Unit: mm (approx. inch)
 Unless otherwise specified, tolerance is $\pm 3\%$
 (however, tolerance is ± 0.3 mm when below 10 mm).

Portable Type (/H5x Option)

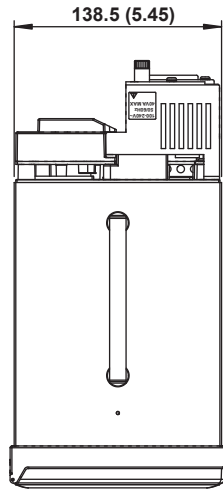

Unit: mm (approx. inch)
Unless otherwise specified, tolerance is $\pm 3\%$
(however, tolerance is ± 0.3 mm when below 10 mm).

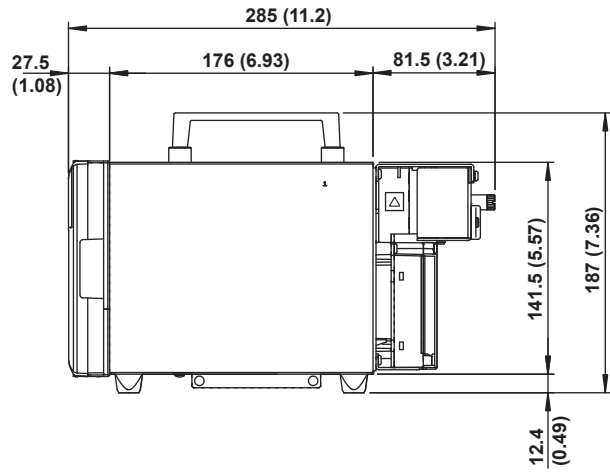
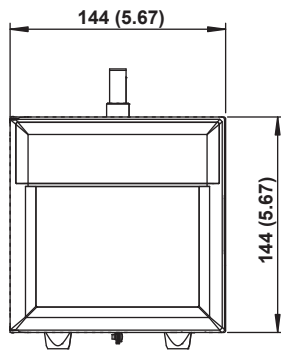
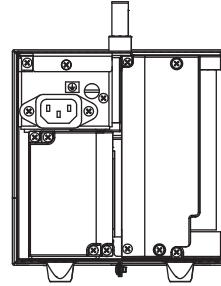

Appendix 1 Periodic Printout and Printout Using the TLOG Timer (/M1 Option)

Periodic Printout

This section explains the contents of the periodic printout. The periodic printout contents vary between the pen model and dot model. The contents also vary depending on whether the periodic printout is in instantaneous mode, report mode, or Off. Instantaneous mode or report mode is specified using **Print1 > Mode** in Basic Setting mode.

The figure below illustrates the printout contents. The font used in the figure differs from that of the actual printout. The printout positions may also differ from those of the actual printout.

Pen Model

Instantaneous Mode

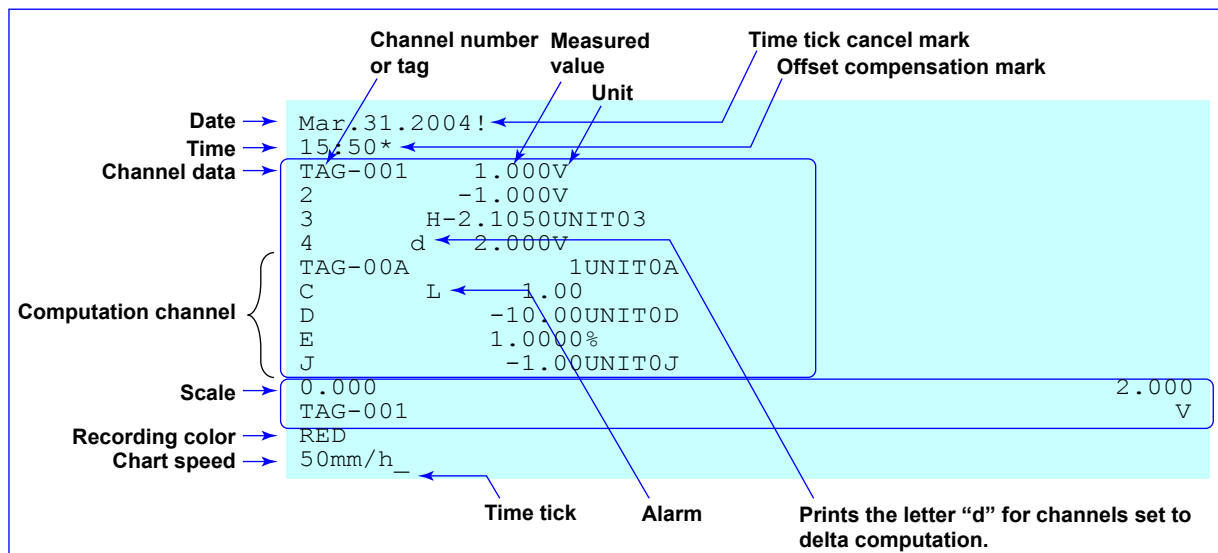

- **Date/Time**
The date/time when the periodic printout was printed on the chart paper.
- **Time tick**
Indicates the reference pen position at the time the periodic printout was printed on the chart paper.
- **Time tick cancel mark**
Prints an exclamation point (!) when the time tick is not printed correctly.
- **Offset compensation mark**
Prints an asterisk (*) when offset compensation is enabled.
- **Channel data**
Prints the channel numbers (1 to 4 or A to J) or tags, measured/computed values, and unit.
Prints the letter "d" on channels set to delta computation.
- **Alarm**
Prints the alarm that is occurring. If multiple alarms are occurring, the alarm with the highest precedence is printed.
Alarm printout precedence: (Higher) H, L, T, t, h, l, R, r (Lower)

- **Scale**
Prints the leftmost and rightmost values of the recording span and the channel number or tag for channels that have scale printout specified. The scale is printed for one channel at each periodic printout. The channel whose scale is printed changes in ascending order. The scale of channels that are being zone recorded is printed within the recording range of the zone.
- **Recording color**
Prints the recording colors of channels that have scale printout and recording color printout specified.
- **Chart speed**
Prints the chart speed.

Report Mode

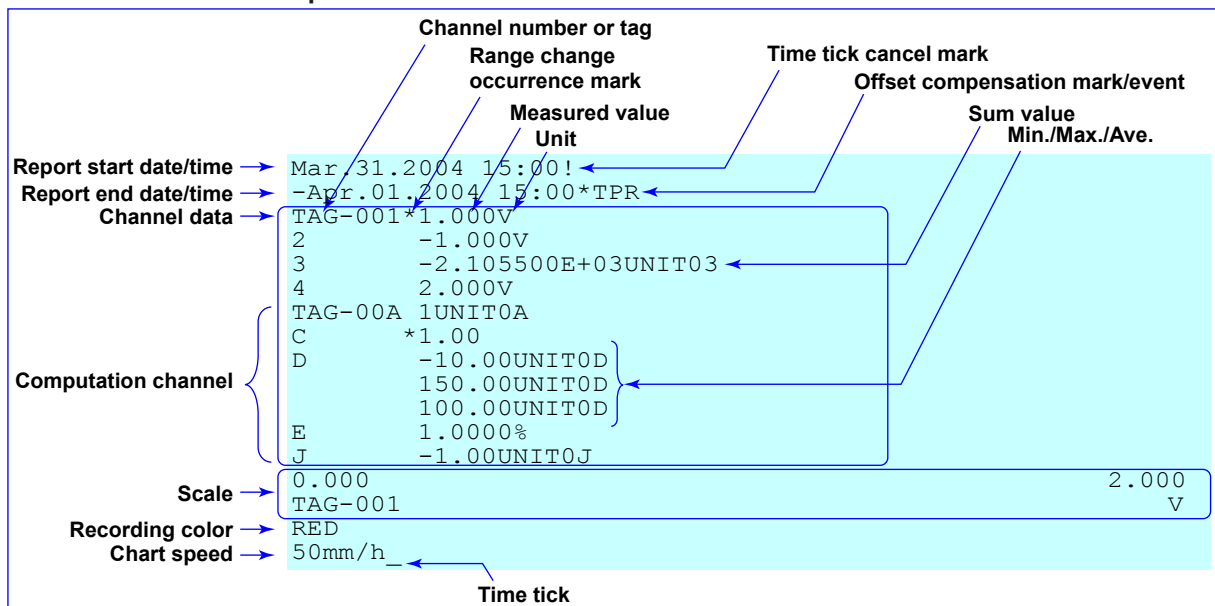

- **Report start date/time and report end date/time**
The start date/time and end date time of the report (statistical calculation) (periodic printout interval).
- **Time tick and time tick cancel mark**
These are the same as with the instantaneous mode.
- **Offset compensation mark**
This is the same as with the instantaneous mode.
- **Event**
Prints the events that occurred in the interval.
T: Time change
P: Power failure or power OFF/ON
R: Data reset
- **Channel data**
Prints the channel numbers (1 to 6 or A to J) or tags, report data, and unit.
An asterisk (*) is printed for channels whose range type was changed in the interval.
- **Scale, recording color, and chart speed**
These are the same as with the instantaneous mode.

Dot Model

Instantaneous Mode

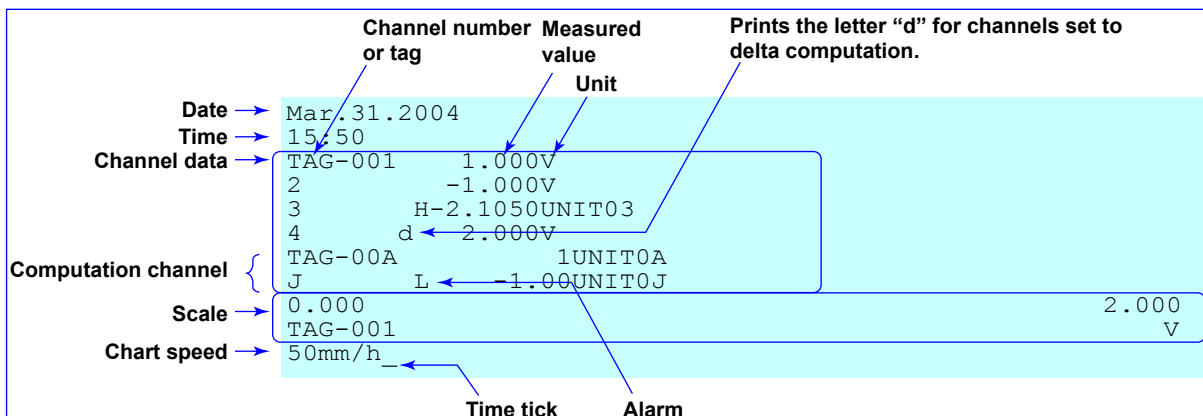

- **Date/Time**
The date/time when the periodic printout was executed.
- **Time tick**
Indicates the position at the time the periodic printout was executed. If the time tick cannot be printed correctly, it is not printed.
- **Channel data, alarm, scale printout, and chart speed**
These are the same as with the instantaneous mode of the pen model.

Report Mode

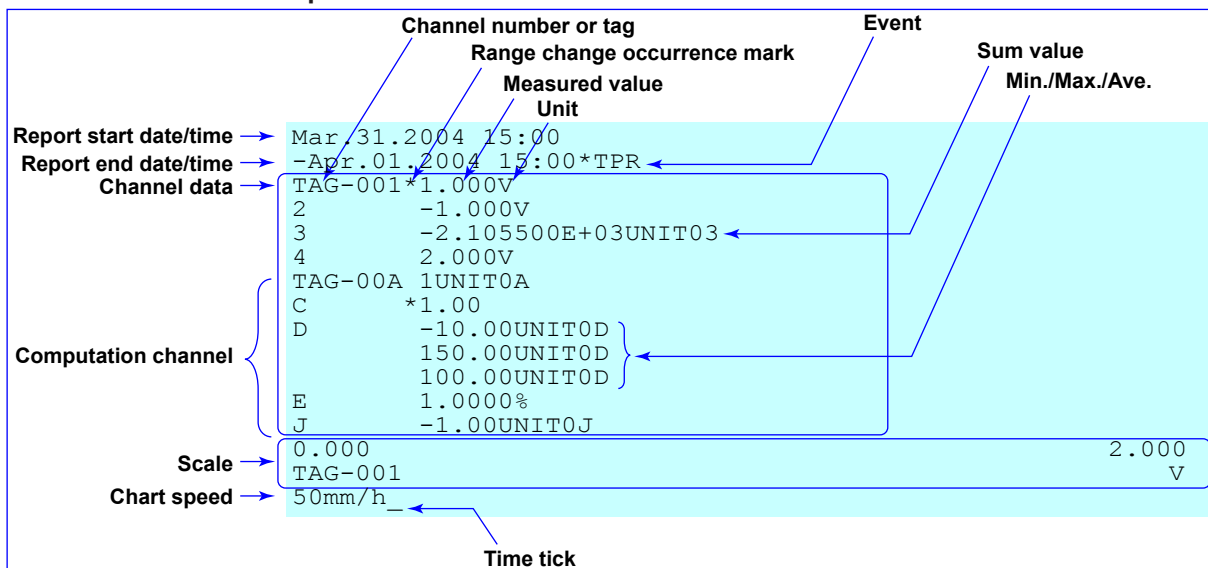

- **Report start date/time and report end date/time**
The start date/time and end date time of the report (statistical calculation) (periodic printout interval).
- **Time tick**
This is the same as with the instantaneous mode.
- **Event**
This is the same as with the report mode of the pen model.
- **Channel data**
This is the same as with the report mode of the pen model. However, the channel numbers are 1 to 6 or A to P.
- **Scale and chart speed**
These are the same as with the instantaneous mode of the pen model.

Printout Using the TLOG Timer (/M1 Option)

Prints the computed values of computation channels for each interval determined by the TLOG timer.

Pen Model

Date	→	Mar 31.2004		
Time	→	15:50*TPR		
Channel data	→	TAG-00A	1	UNIT0A
		B	1.0	
		C	L ← 1.00	
		G	-1.0	
		J	-1.00	UNIT0J
Scale	→	-100		100
		TAG-00A		UNIT0A
Recording color	→	RED		
Timer	→	TLOG1		

- **Date/Time**
The date/time when the printout using the TLOG timer was executed.
- **Offset compensation mark, scale, and recording color**
These are the same as with the periodic printout of the pen model.
- **Event**
This is the same as with the report mode of the periodic printout of the pen model.
- **Channel data**
Prints the computation channel numbers (A to J) or tags, computed values, and unit.
- **Alarm**
This is the same as with the instantaneous mode of the periodic printout of the pen model.
- **Timer**
Prints the timer number being used.

Dot Model

Date	→	Mar 31.2004		
Time	→	15:50*TPR		
Channel data	→	TAG-00A	1	UNIT0A
		C	L ← 1.00	
		D	100.00	UNIT0D
		E	1.0000%	
		G	-1.0	
		J	-1.00	UNIT0J
Scale	→	-100		100
		TAG-00A		UNIT0A
Timer	→	TLOG2		

- **Date/Time**
The date/time when the printout using the TLOG timer was executed.
- **Event**
This is the same as with the report mode of the periodic printout of the pen model.
- **Channel data**
Prints the computation channel numbers (A to P) or tags, computed values, and unit.
- **Alarm**
This is the same as with the instantaneous mode of the periodic printout of the pen model.
- **Scale**
These are the same as with the periodic printout of the pen model.
- **Timer**
Prints the timer number being used.

Special Cases

This section explains the operation of the periodic printout report (statistical calculation) and the TLOG computation for special cases. In the explanation below, statistical calculation represents computation in periodic printout report mode or TLOG computation.

Operation during Power Failures

If a power failure occurs in the middle of statistical calculation, the operation is as follows when the power recovers.

The statistical calculation resumes when the power recovers. The exact operation will vary depending on whether the power is restored before or after the printout time.

Time of Recovery	Type	Statistical Calculation Operation
After the printout time	TLOG computation	Statistical calculation data is printed immediately after power is restored. The measured/computed data up to the time of the power failure is used. At the next printout time, data after the power recovery is used to create and print the statistical calculation data.
	Periodic printout	Periodic printout is not performed immediately after power is restored. It is printed on the first printout time after recovery. The data used is measured/computed data from before and up to the power failure, and from the time of recovery up to the printout time. The "report start date/time" in this case is the periodic printout date/time closest to and prior to the power failure. The "report end date/time" is the current periodic printout date/time.
Before the printout time	TLOG computation	The data is printed at the printout time after the power recovers. The measured/computed data excluding the power failure period is used.
	Periodic printout	

Procedure of Handling "Over" Values during Periodic Printout

When an "over" value* is input for sum or average computation, that value is not used in the computation.

- * An "over" value on a measurement channel refers to +Over or -Over. See section 12.4.
- An "over" value on a computation channel refers to a value that is less than or equal to -100000000 or greater than or equal to 100000000 excluding the decimal.

Appendix 2 Periodic Printout Interval

The periodic printout function prints measured values and other data numerically at the left side of the chart paper while performing trend recording.

The periodic printout interval varies depending on the chart speed and setup conditions.

Periodic Printout Example of the Dot Model

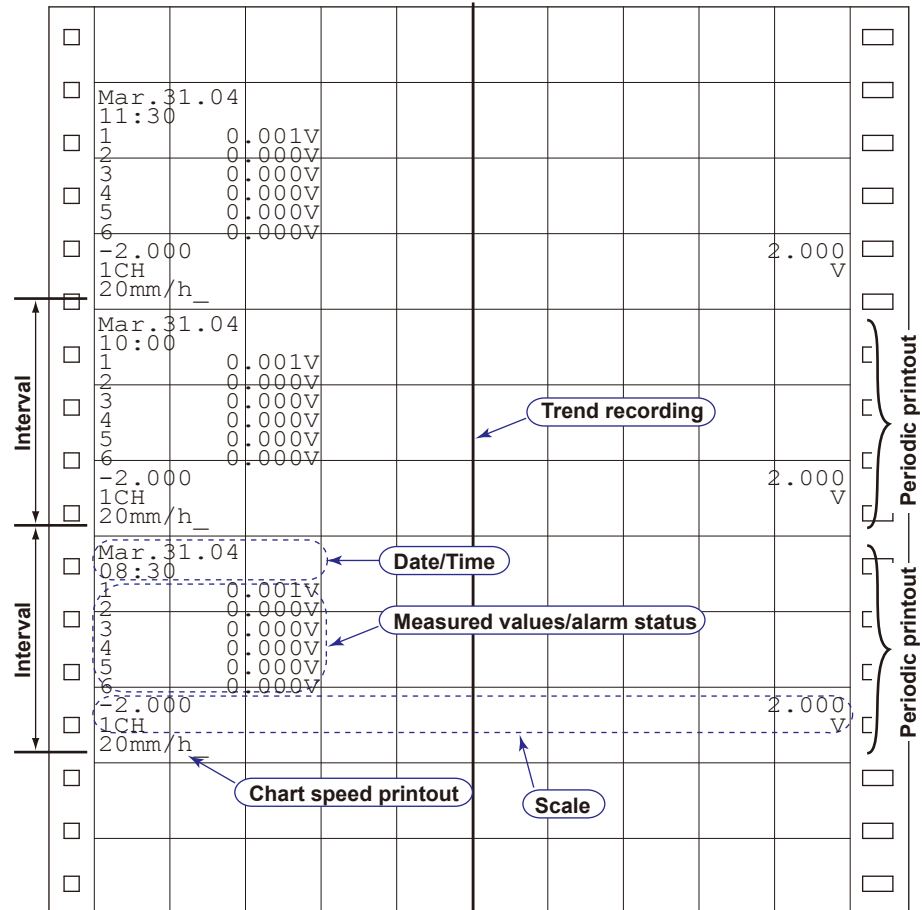

The figure above is used to explain the printout contents. The actual printout and font are different from those illustrated in the figure. The printout positions are also slightly different.

When the Interval Is Set to Auto

Printout is performed at the interval corresponding to the chart speed.

Pen Model		Dot Model	
Chart Speed	Periodic Printout Interval	Chart Speed	Periodic Printout Interval
Up to 9 mm/h	Not printed	Up to 9 mm/h	Not printed
10 to 18 mm/h	8 hours	10 to 19 mm/h	8 hours
20 to 36 mm/h	4 hours	20 to 39 mm/h	4 hours
40 to 72 mm/h	2 hours	40 to 79 mm/h	2 hours
75 to 135 mm/h	1 hour	80 to 100 mm/h	1 hour
150 to 180 mm/h	30 minutes	101 mm/h or higher	Not printed
200 to 320 mm/h	20 minutes		
360 to 1500 mm/h	10 minutes		
1600 mm/h or higher	Not printed		

When the Interval Is Set to Manual

If you select Manual, you can set the interval.

- **Chart Speeds That Allows Periodic Printout**

Pen Model		Dot Model	
Chart Speed	Printout Availability	Chart Speed	Printout Availability
Up to 9 mm/h	No	Up to 9 mm/h	No
10 to 1500 mm/h	Yes	10 to 100 mm/h	Yes
1600 mm/h or higher	No	101 mm/h or higher	No

- **Interval Settings**

Select from 10, 12, 15, 20, 30 minutes, 1, 2, 3, 4, 6, 8, 12, and 24 hours.

- **Printout Items**

Item	Number of Lines	Initial Setting	Notes (Ref. Section)
Date/Time	2	-	Always printed.
Measured value and alarm status	1 line/channel	Printed	Print or not print selectable for each channel (section 6.6).
Scale	2	Printed	Print or not print selectable (section 7.7).
Pen color (Pen model only)	1	Printed	Print or not print selectable (section 7.7).
Chart speed	1	-	Always printed.

- **Relationship between the Printout Items and Interval**

The next periodic printout does not start until all items of the previous periodic printout are printed.

If all items cannot be printed in the specified interval, the printout interval increases by an integer multiple of the specified interval.

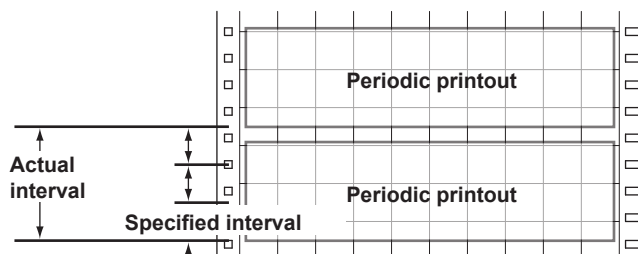

Example: Dot model, chart speed: 20 mm/h, interval: 30 minutes, all other settings at default.

- This setting requires 11 lines to be printed which is equivalent to approximately 28 mm* of chart paper.
- The length of chart paper that is fed within the interval is 10 mm.
 - * The length of chart paper needed in the printout varies depending on the chart speed and dot printing interval.

Not all items can be printed in the specified interval of 30 minutes. The actual interval is 1 hour and 30 minutes.

If you want to print at a shorter interval, change the settings as follows:

- Reduce the number of printed items.
- Increase the chart speed within the printable range.

Note

Measurement, display, periodic printout, and trend recording (dot model) are not performed by setting unused channels to Skip (see section 5.1).

Blank

Index

Symbols

-Over.....	12-8
+Over.....	12-8

Numerics

1-5V.....	1-2
1-5V input.....	5-6
1-5V low-cut function.....	7-24

A

absolute time mode.....	9-21
absolute value.....	1-26
absolute values, setting using.....	6-15
accuracy of clock.....	12-22
activating the key lock.....	3-19
adjusting the dot printing position.....	11-8
adjusting the hysteresis.....	11-8
adjusting the pen position.....	11-6
alarm.....	1-7, 5-9
alarm ACK.....	1-12, 3-18
alarm acknowledge operation.....	1-12, 3-18
alarm delay function.....	7-24
alarm hysteresis.....	1-8, 1-28, 7-3
alarm indication.....	1-9
alarm information.....	7-11
alarm output relay.....	2-10
alarm output relays.....	1-9
alarm output terminals.....	2-9
alarm printout.....	1-18
alarms on the delta computation channel.....	5-10
alarm type.....	5-10, 9-12, 12-3
alarm value.....	5-11, 9-12
AND operation (alarm output relay).....	1-11
AND/OR.....	7-3
assigned function (remote control).....	7-29
assigning channels to recording pens.....	9-24

B

bar graph.....	1-24
base point of the bar graph.....	7-15, 9-27
basic setting mode.....	4-1
batch action, setting of.....	6-18
batch comments.....	6-17
batch name.....	1-22
batch number.....	1-22, 6-16
batch printout, turning ON/OFF of.....	6-17
bias.....	1-4, 6-13
bias function.....	7-24
brightness (display).....	6-12
brightness (internal light).....	6-12
buffer memory.....	1-18, 1-19
buffer overflow mark.....	1-18, 1-19
burnout detection.....	1-4, 7-5

C

calibration.....	11-4
calibration correction.....	1-4
calibration correction function.....	7-24
calibration correction, performing of.....	6-14
calibration instrument.....	11-4
cassette holder.....	3-10

changing the settings.....	4-3
channel auto switching.....	3-12
channel printout.....	1-17
channel range.....	5-10, 6-13
channel switching interval.....	8-3
character type.....	4-4, 9-3
chart cassette.....	3-4
chart end output.....	1-29
chart holder.....	3-5
chart paper.....	3-5, 12-4
chart paper guide.....	3-5
chart speed.....	1-14, 5-13
cleaning.....	11-2
clearing alarm information.....	3-15
comment line.....	4-3
common logarithm.....	1-26
communication input data.....	9-4
compensation voltage.....	7-7
computation-dedicated channels.....	1-26
computation errors.....	9-29
computing equation.....	9-2
computing equations.....	9-4
constants.....	9-4, 9-10
construction.....	12-18
conventions used in this manual.....	xii
copying & pasting a character string.....	4-4, 9-3
correction values.....	1-4
current input.....	1-2
cursor.....	4-3, 4-4
customized menu.....	1-32

D

data display setup screen.....	8-1
data types (computation).....	1-26, 9-4
date format.....	7-30
date/time.....	2-13, 5-14
DC voltage.....	5-2
de-energized.....	1-11, 7-3
default values (basic setting mode).....	4-11
default values (setting mode).....	4-9
delay high limit alarm.....	1-8
delay low limit alarm.....	1-8
deleting a character.....	4-4, 9-3
deleting an entire character string.....	4-4, 9-3
delta computation.....	1-3, 5-4
diagnosis output.....	1-9, 7-2
difference high limit alarm.....	1-7
difference low limit alarm.....	1-7
dimensional drawings.....	12-23
display.....	1-24
display and key panel.....	3-2
displayed contents.....	12-7
display examples.....	1-25
display in which different screens can be assigned.....	8-4
display/recording language.....	7-22
display type.....	1-24
display update rate.....	8-2
dot printing interval.....	1-14, 6-1
DST.....	1-33
duration (alarm delay).....	6-11, 9-19

Index

E

edge.....	1-31
effects of operating conditions.....	12-22
EMC standards.....	iv
end printout.....	1-22, 6-16
end printout 2.....	6-16
energized.....	1-11, 7-3
English, setting the language.....	7-22
entering basic setting mode.....	4-2
entering characters.....	4-4
entering setting mode.....	4-2
entering values.....	4-3
error messages.....	10-1
ESC key.....	4-3
exponent.....	1-26
external reference compensation.....	1-5

F

FAIL/chart end output relay.....	2-10
FAIL output.....	1-29
fastest recording interval.....	1-28
feeding the chart paper.....	3-6
felt pen.....	3-7
filter.....	1-5, 6-3, 7-20
format of the date.....	1-19
four arithmetic operation.....	1-26, 9-5
front cover tab of the chart cassette.....	3-11
FUNC key operation.....	4-5

H

half life of the brightness.....	11-10
handling precautions.....	2-1
header printout.....	1-22
heat sink.....	3-3
high limit alarm.....	1-7
high limit on rate-of-change alarm.....	1-7
hold.....	1-9, 1-12
hold operation.....	7-3
hysteresis.....	1-8

I

initializing the recorder settings.....	7-27
input computation.....	12-2
input range.....	5-1
input type.....	12-1
inserting a character.....	9-3
inserting characters.....	4-4
installation location.....	2-2
instantaneous mode.....	App-1
integration time of the A/D converter.....	1-6, 7-4
internal clock adjustment.....	1-30
internal light LED assembly.....	11-3
interval (periodic printout).....	App-6
interval (rate-of-change alarm).....	1-7, 7-3
isolation.....	12-19

K

key lock.....	3-19, 7-18
keys.....	3-2
keys to be key-locked.....	7-18

L

language.....	7-22
level.....	1-31
linear scaling.....	5-3
List.....	3-14
loading the chart paper.....	3-4
logical computation.....	1-26, 9-6
lot number.....	1-22
lot number, setting of.....	6-16
low-cut.....	5-6, 5-8
low limit alarm.....	1-7
low limit on rate-of-change alarm.....	1-7

M

main display.....	1-24
manual printout.....	1-19, 3-13
measurable range.....	1-2
measuring input terminal.....	2-5
memory backup.....	12-22
menu (basic setting mode).....	4-8
menu, customization of.....	1-32
menu (data display setup).....	8-2
menu (setting mode).....	4-7
message.....	6-9
message format.....	6-20
message printout.....	1-19
message printout including measured value.....	1-23
message printout including measured value in.....	6-20
model.....	vii
mounting brackets.....	2-3
mounting hole.....	3-1
moving average.....	1-5, 7-19

N

names of parts.....	3-1
new chart speed printout.....	1-19
non-hold.....	1-9, 1-12
non-hold operation.....	7-3
normal operating conditions.....	12-18
number of samples of moving average.....	6-4

O

offset compensation mark.....	App-1
ON/OFF input.....	5-5
opening the display.....	x
operation menus using the FUNC key.....	4-5
operation mode.....	4-1
operations on the panel keys.....	4-2
optional accessories.....	ix
optional functions.....	12-13
optional terminal.....	2-8
order of precedence of computation.....	9-4
over value.....	9-29
over values during periodic printout.....	App-5

P

packing materials.....	x
panel.....	2-3
panel cut dimensions.....	12-23
parallel connection.....	2-5
partial expanded recording.....	1-15, 6-6, 7-21, 9-16
password for releasing the key lock.....	7-18
password (key lock).....	3-19
pen caps.....	3-7
pen holder.....	3-7

pen offset compensating data, ejection of 1-22
 pen offset compensation 1-15, 7-9
 periodic inspection 11-1
 periodic printout 1-18, 9-17, App-1
 periodic printout, disabling of 7-14
 periodic printout interval 7-14, App-6
 plotter pen 3-8
 POC 7-9
 portable type 12-16, 12-24
 power and other computations 9-5
 power (computation) 1-26
 power failure App-5
 power supply 12-18
 power switch 2-13
 precautions (input signal wiring) 2-4
 precautions (optional terminal wiring) 2-8
 precautions (power supply wiring) 2-11
 printing a message 3-16
 printing the computed value 9-22
 printing the recorder settings 3-14
 printout contents 1-16
 printouts 12-5
 printout using the TLOG timer App-4
 protective ground terminal 2-12

R

range type 1-2
 rear panel 3-3
 recorder 1-1
 recorder's version iii
 recording 1-13
 recording color 1-14, 7-8, 7-11, 9-23
 recording (computation channels) 1-27
 recording span 1-2
 recording start printout 1-19
 recording zone 6-5, 9-15
 reference junction compensation 1-4
 reference pen 1-15
 reference time 7-14
 reflash alarm 1-10, 7-3
 registering display types to screens 8-3
 relational computation 1-26, 9-6
 relative time mode 9-21
 relay contact input 2-10
 relay contact output 2-10
 relay numbers 5-11, 9-12
 releasing the alarm output 3-18
 releasing the key lock 3-19
 remaining chart length 11-1
 remote control 1-30, 7-28
 remote control input 2-10
 remote control input terminals 2-9
 remote signal 1-31
 replacement period for expendable parts 11-10
 replacing felt pens 3-7
 replacing the internal light LED 11-3
 replacing the plotter pen 3-8
 report data 7-14, 9-26
 report mode App-2
 resetting the computed values 9-1
 resetting the report data 3-17
 resetting the TLOG computed value 9-22
 revise values, setting using 6-15
 revisions ii
 ribbon cassette 3-10
 ribbon feeding knob 3-10
 RJC 7-7

RTD 5-2
 run modes 4-1

S

safety precautions iv
 safety standards iv
 safety symbols iv
 scale printout App-2
 scaling 1-3
 scan interval 1-2
 SD memory card 1-23
 secondary chart speed 6-10
 Setting complete screen 4-3
 setting mode 4-1
 settings necessary to use various functions 1-34
 Setup 3-14
 setup guide 1-34
 setup items (basic setting mode) 4-11
 setup Items (setting mode) 4-9
 shunt resistor 1-2
 skip 5-8
 sprocket teeth 3-5
 square root 1-26
 square root computation 1-3, 5-7
 square root low-cut function 7-24
 standard accessories viii
 standard performance 12-20
 standard temperature device 11-5
 starting the computation 9-1
 start printout 1-22, 6-16
 start printout 2 6-16
 start recording 3-11
 status display 1-24
 status of the remote control input terminal 9-5
 stoppers 3-4
 stopping the computation 9-1
 stop recording 3-11
 suffix code vii
 SUM scale 7-14, 9-14, 9-26
 supported standards 12-19
 switching the display screen 3-12

T

tag 6-8, 7-11, 9-18
 TC 5-2
 temperature unit 7-42
 thermocouple 5-2
 thermocouple input 2-5
 time constant 6-3
 time printout format 1-18, 7-26
 timer 9-21
 time tick 1-16, App-1
 time tick cancel mark 1-16, App-1
 TLOG computation 1-26, 9-8
 transistor input 2-10
 trend recording 1-14, 6-7, 9-17, 12-4
 trend recording interval 1-14, 6-1
 trigger 1-31
 troubleshooting 10-4
 type of measured values 7-14
 type of report data 9-26
 types of computations 1-26
 types of inputs 1-2

Index

U

unit..... 5-12, 9-9
unit in computations..... 1-27

V

versions and functions..... iii
VFD 1-24
Volt..... 5-2

W

wiring (measuring input) 2-7
wiring (optional terminal) 2-8
wiring (power supply)..... 2-11

Z

zone recording..... 1-14